



Bauanleitung

**Building
Instructions**

NASA

**Mobile Launch
Platform
(MLP)
STS-1**

Maßstab

1:220

Scale

Februar

2021

February

© 2021 Harald Kränzel

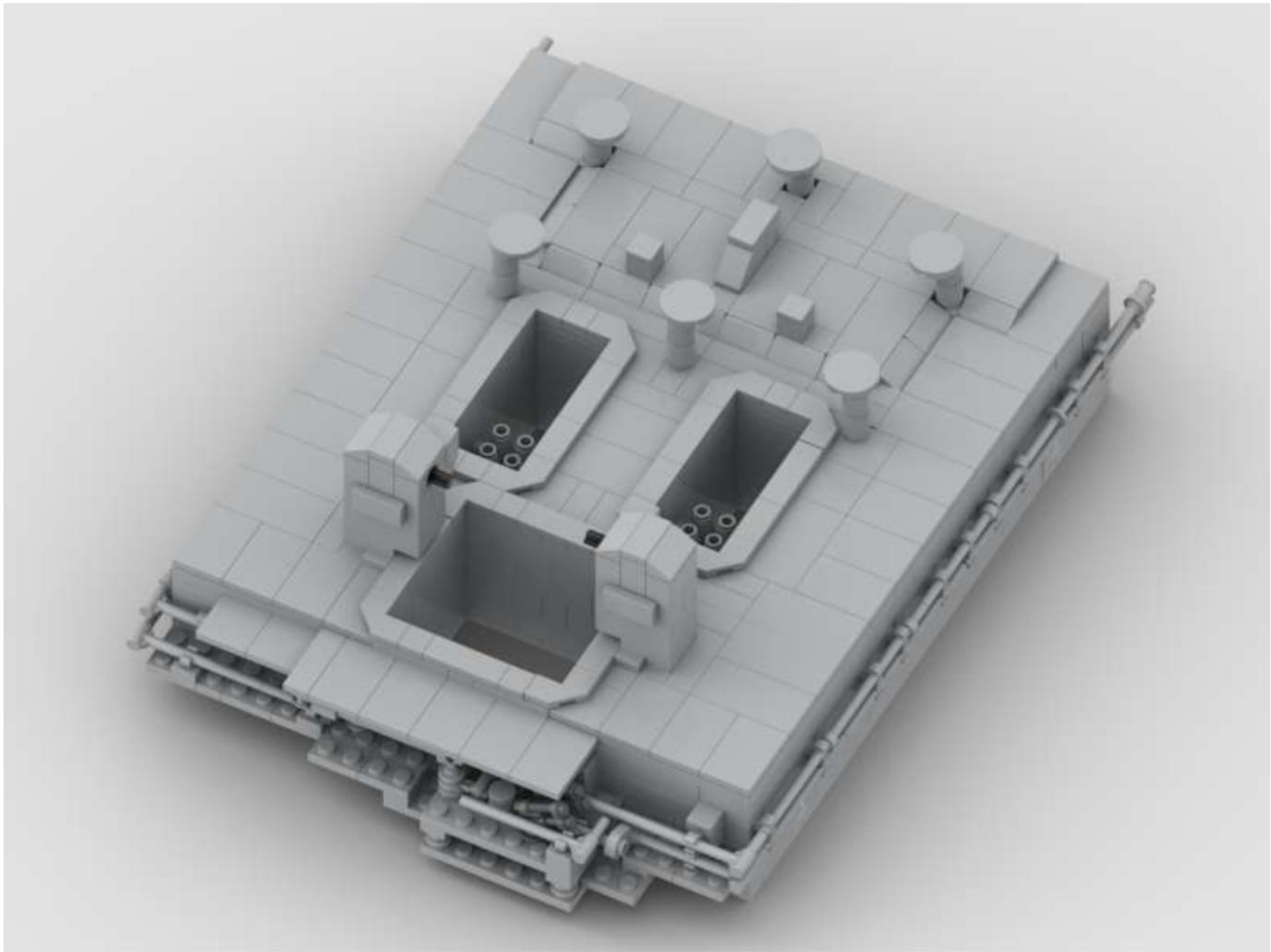

1

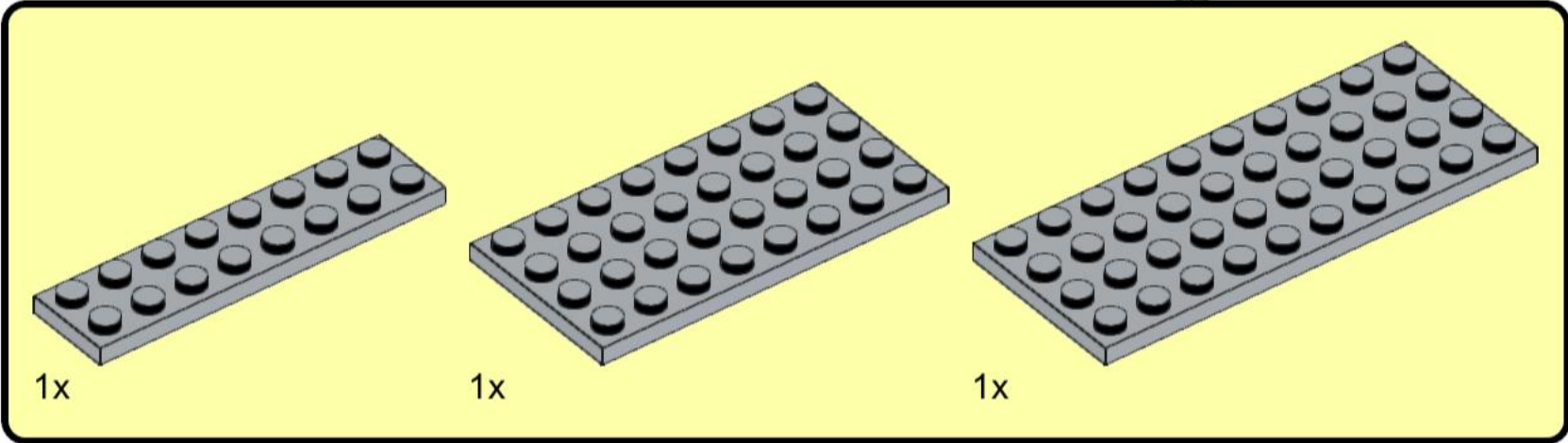
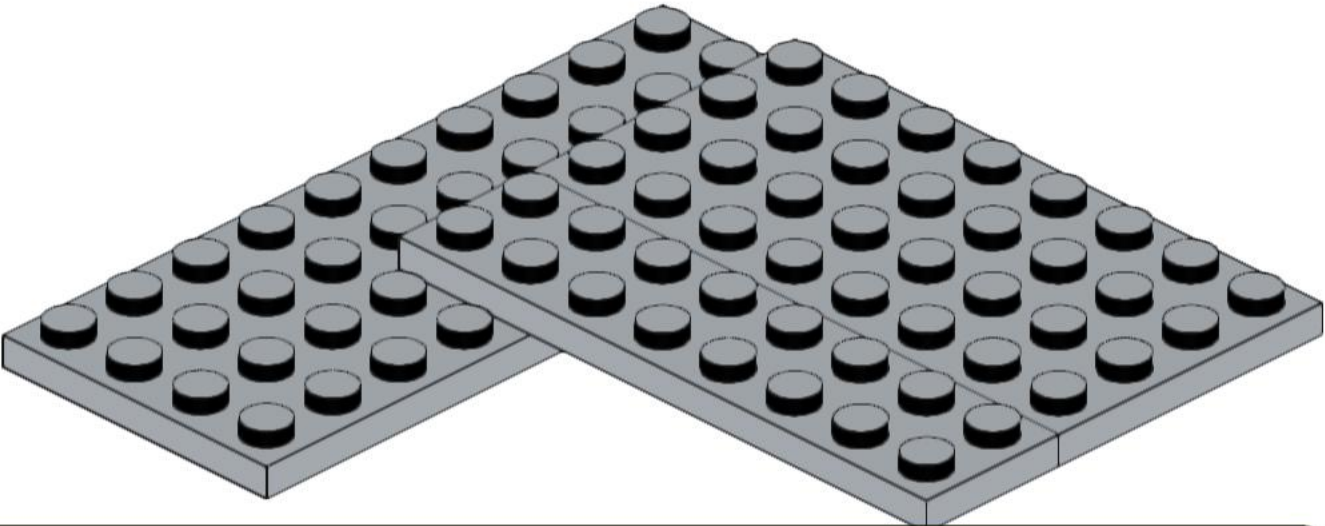
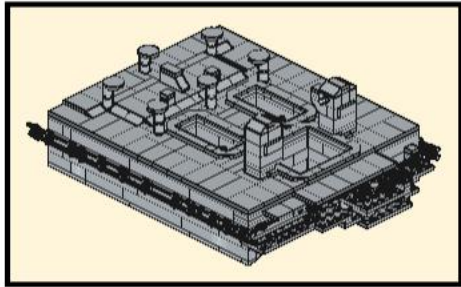

1x

1x

1x

2

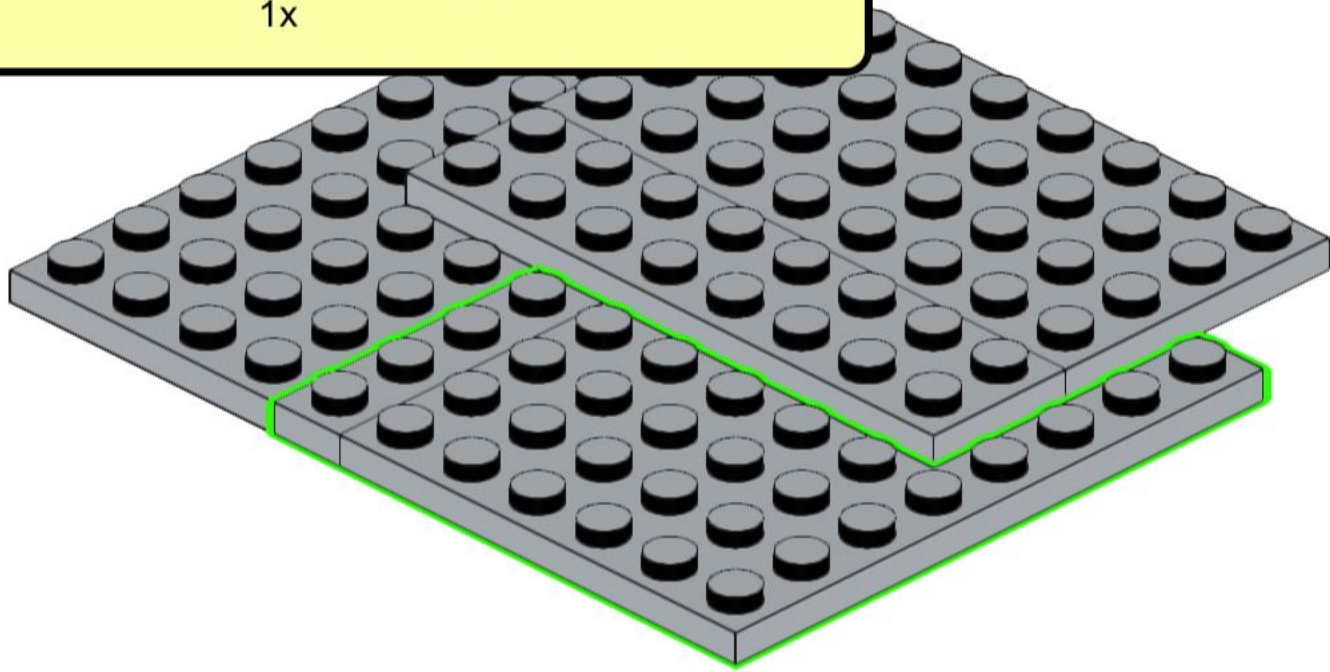
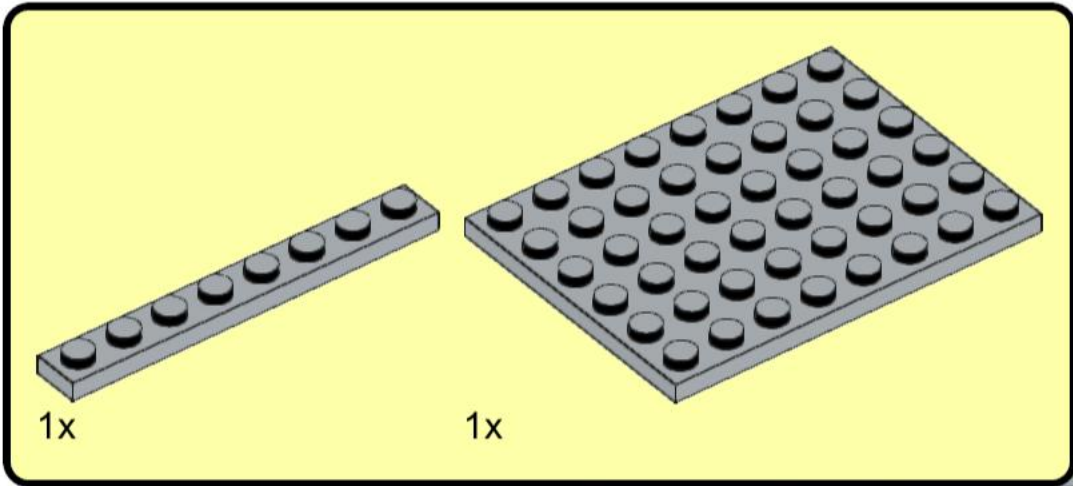

3

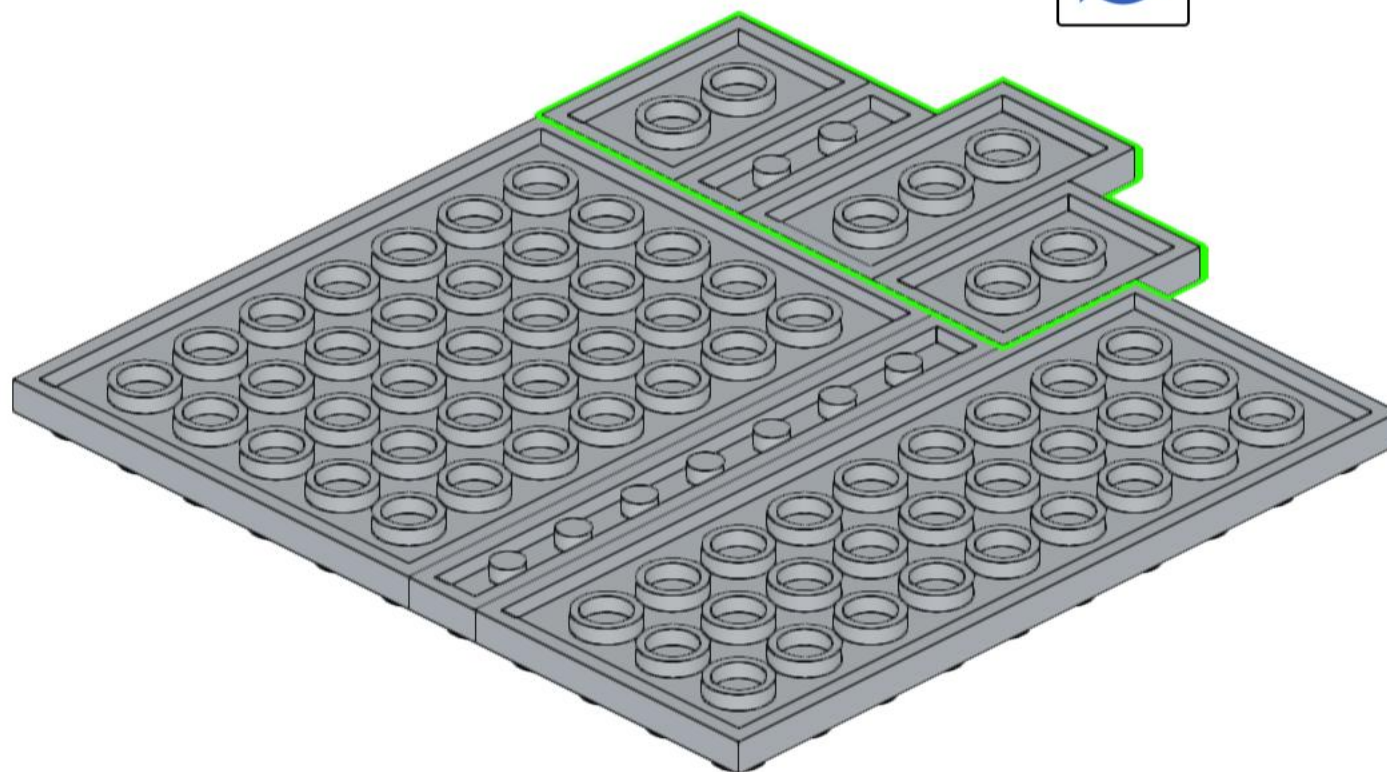
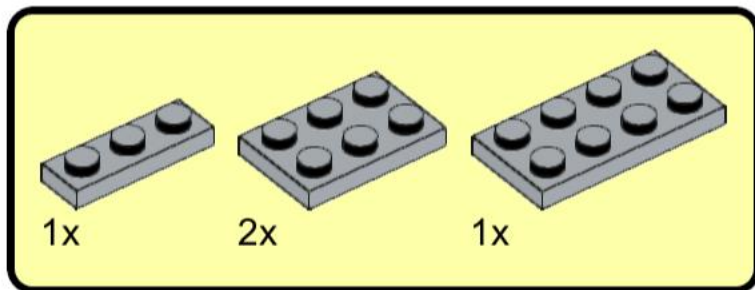

4

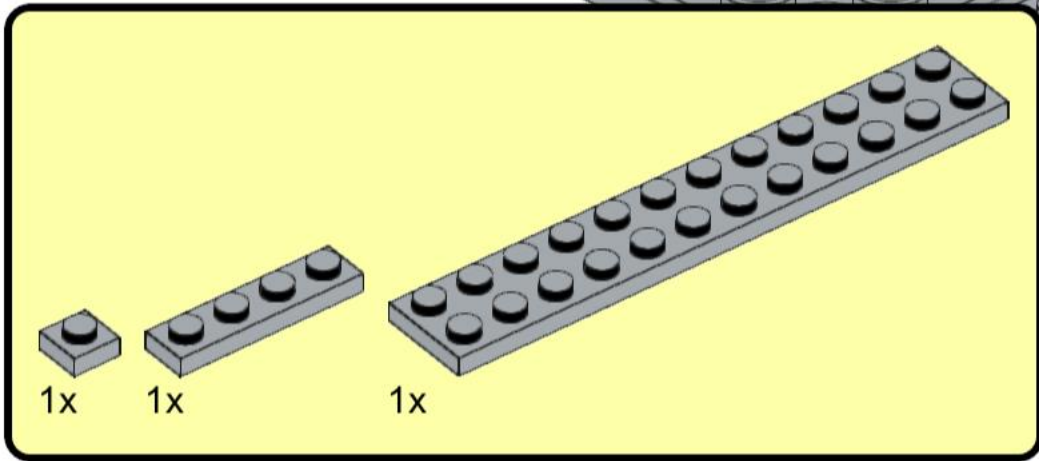
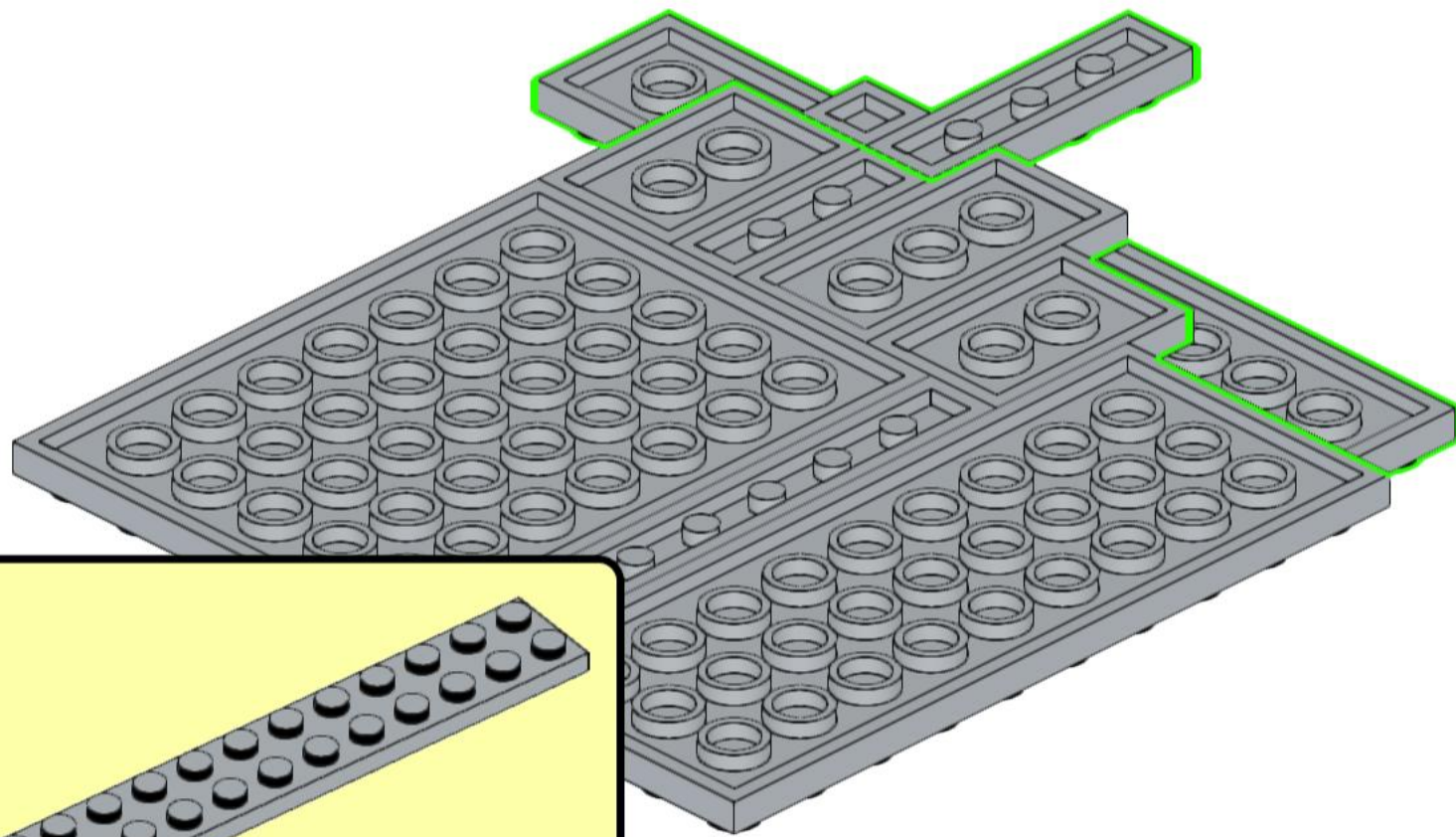

5

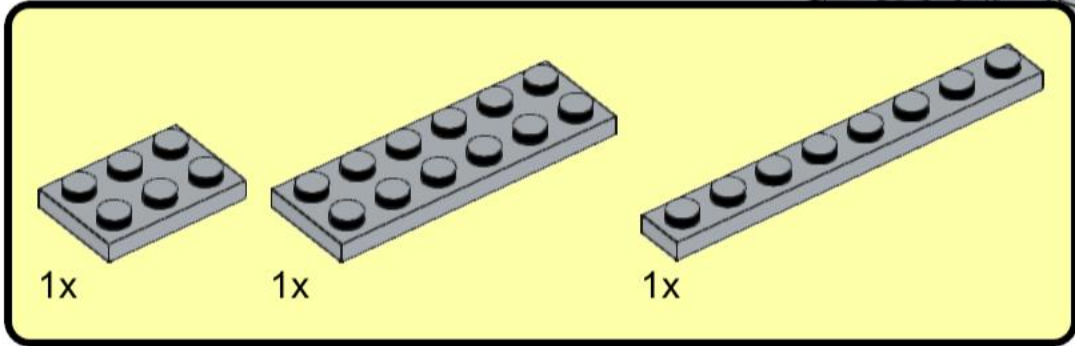
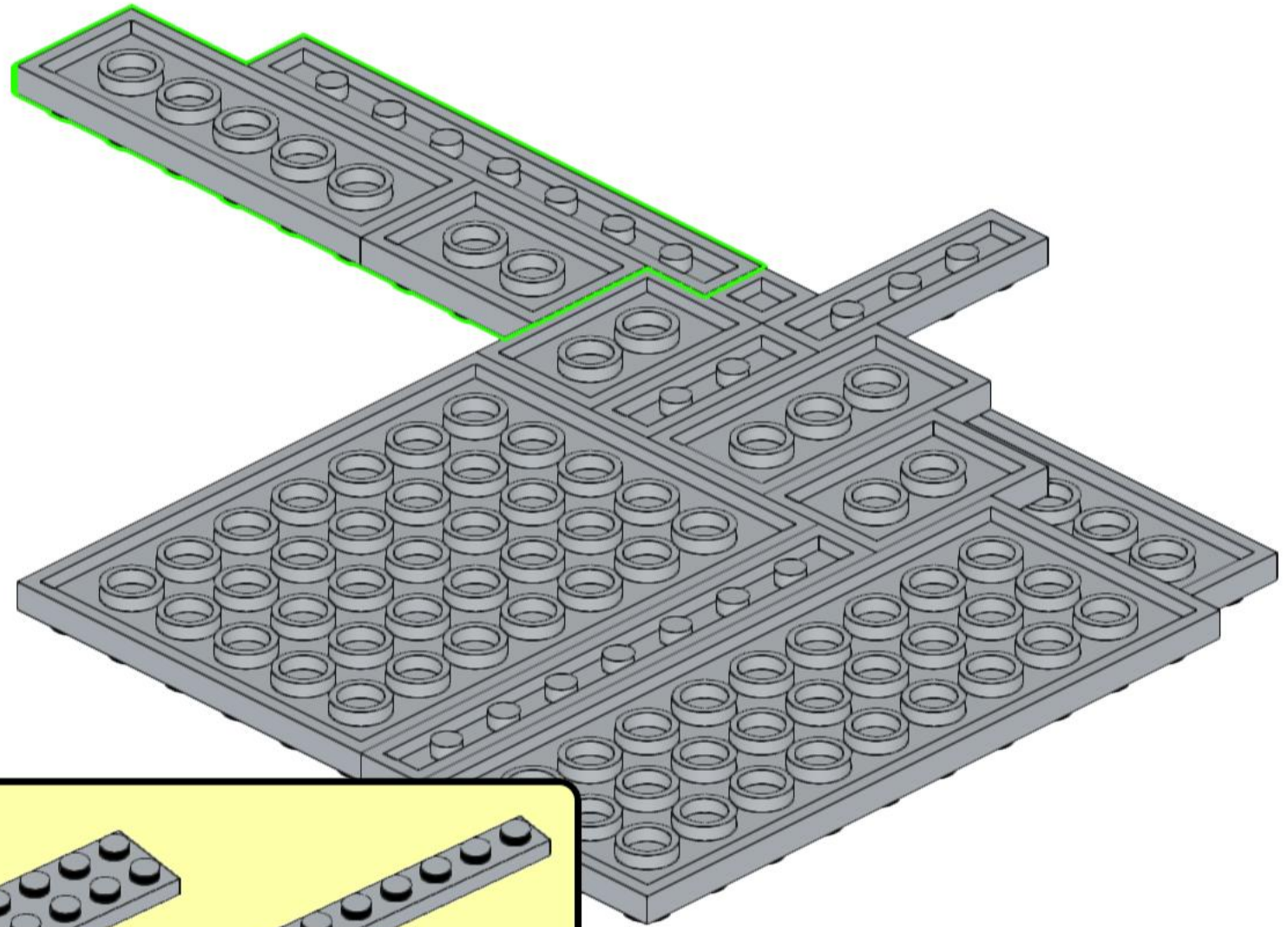

6

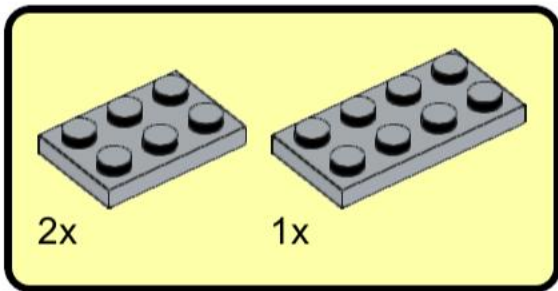
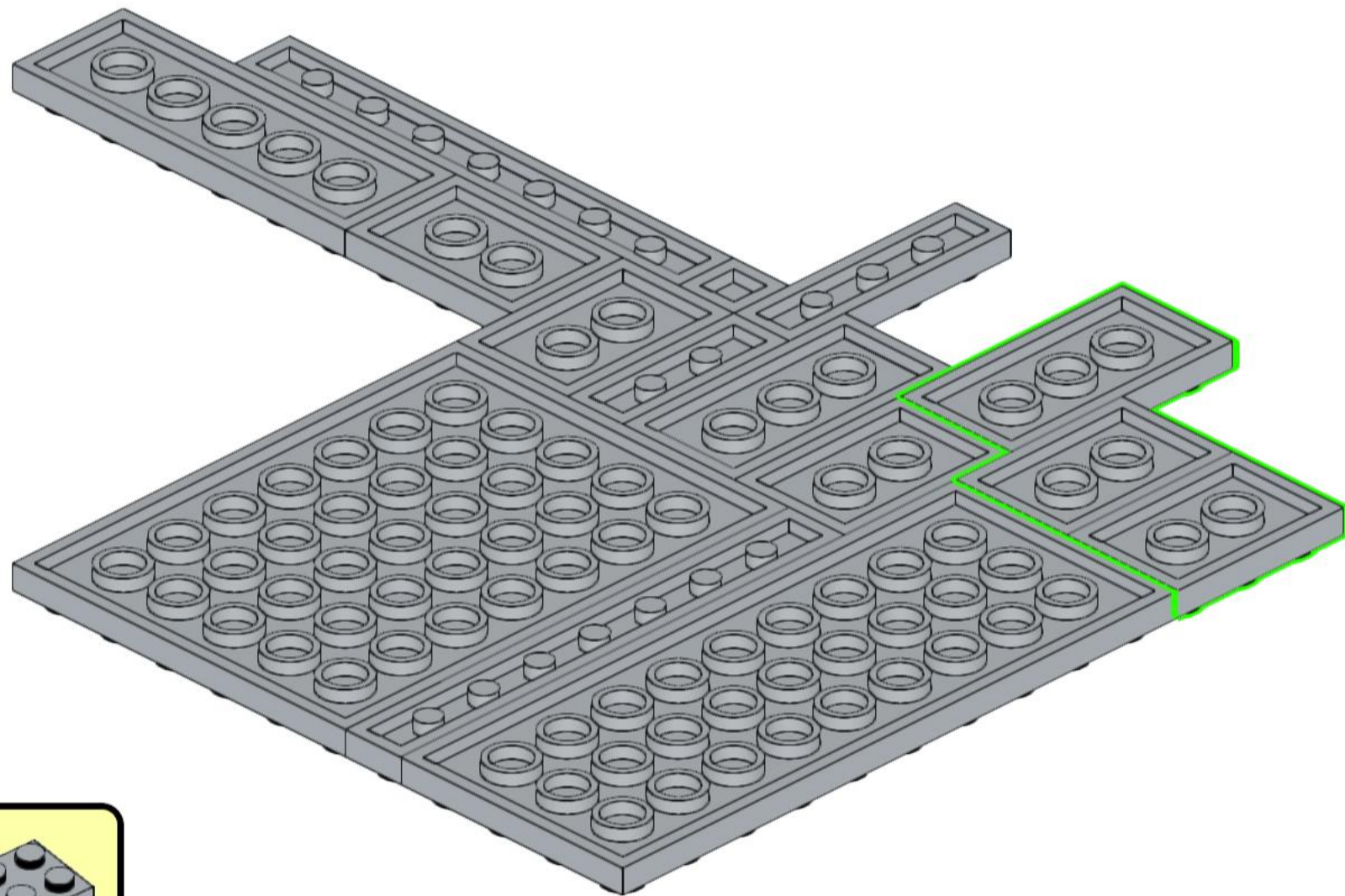

7

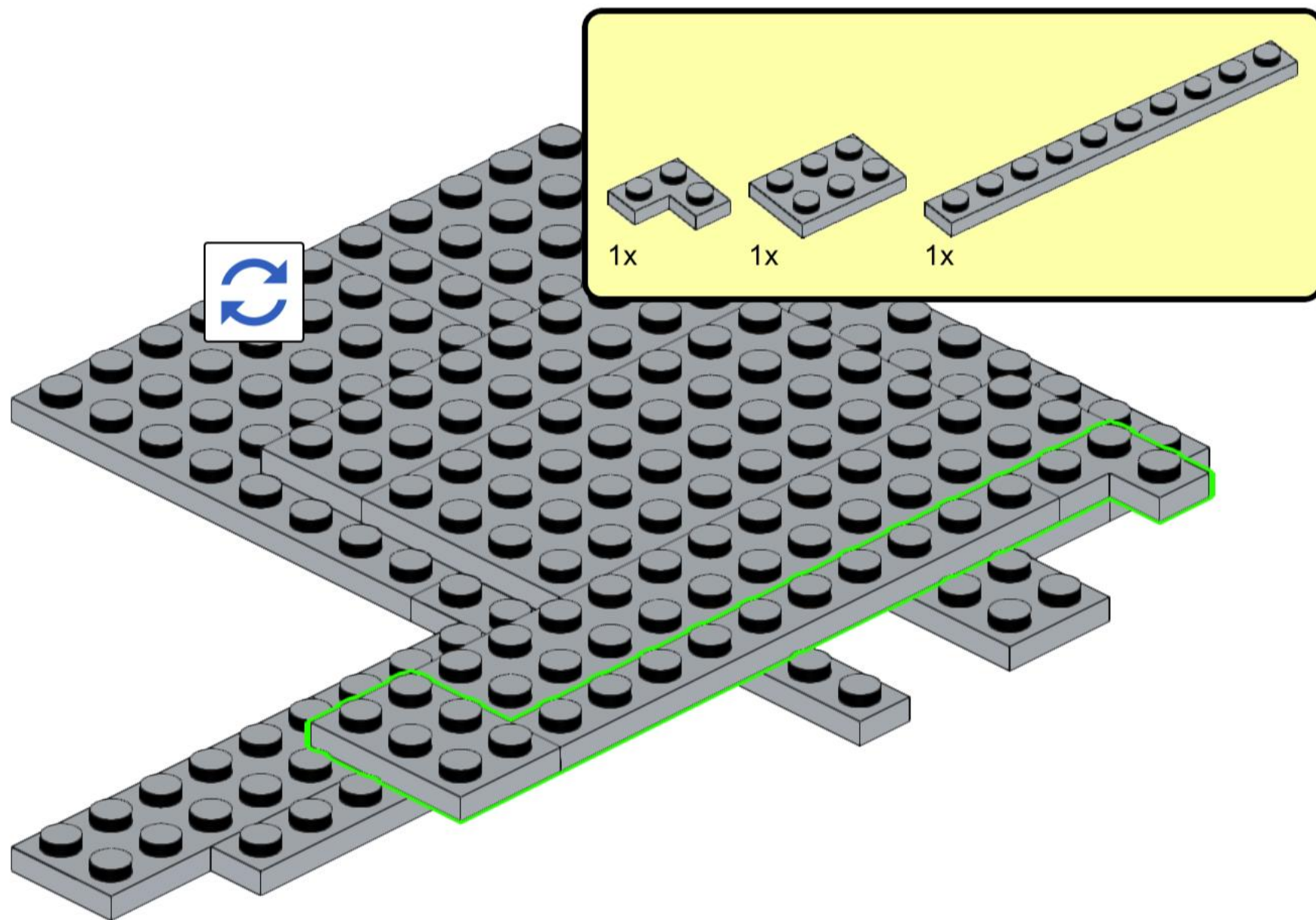

8

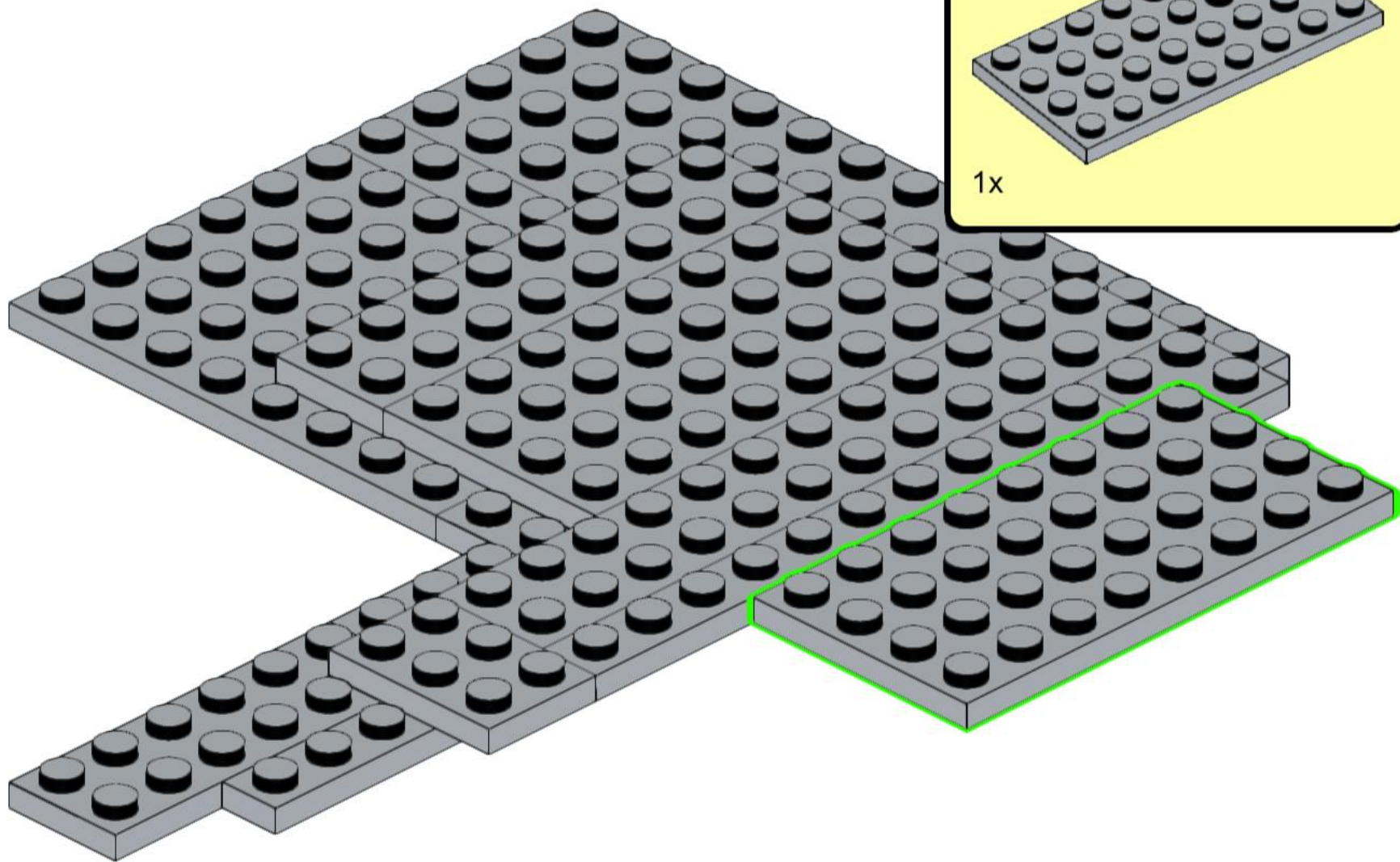

9

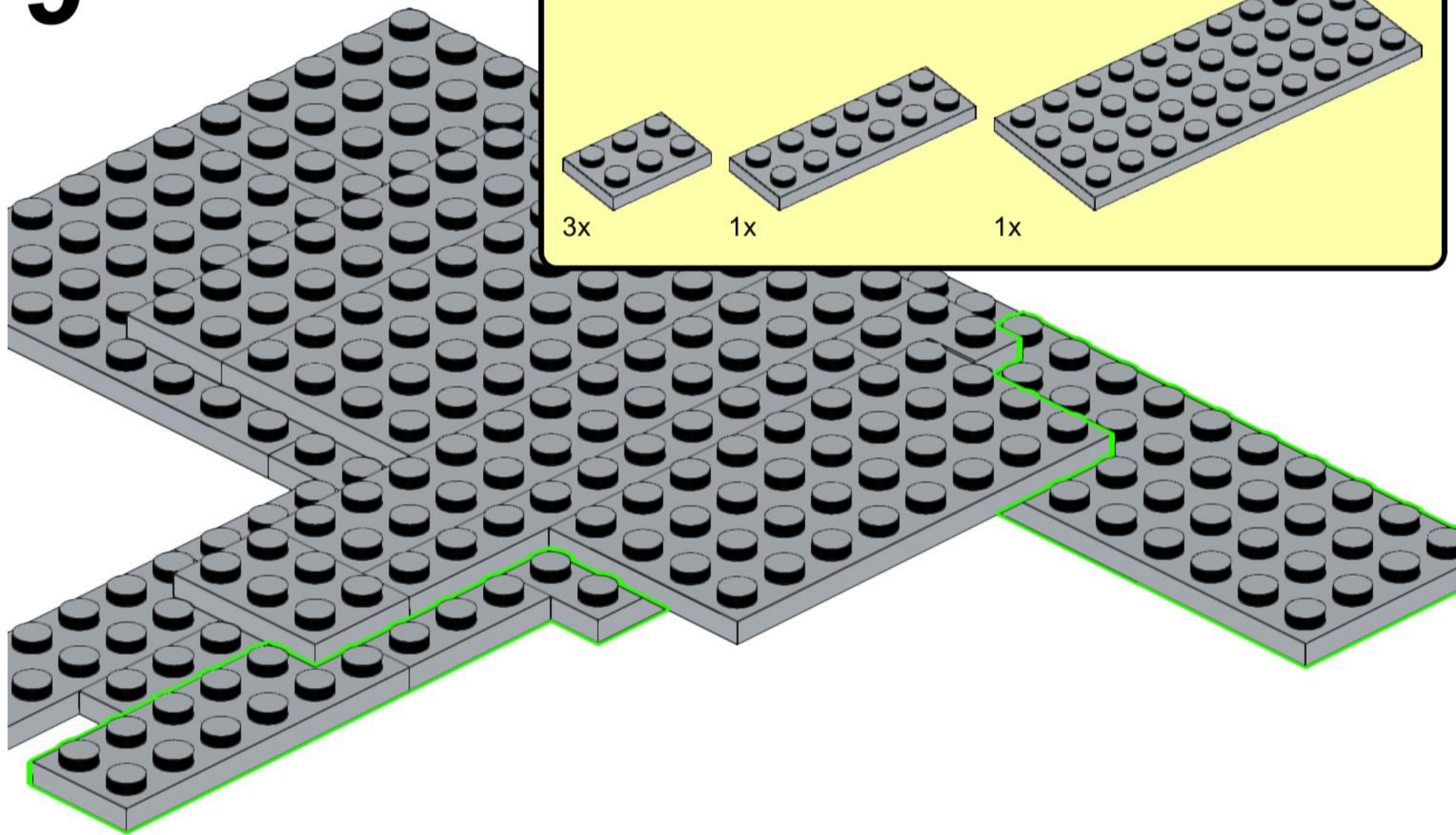

10

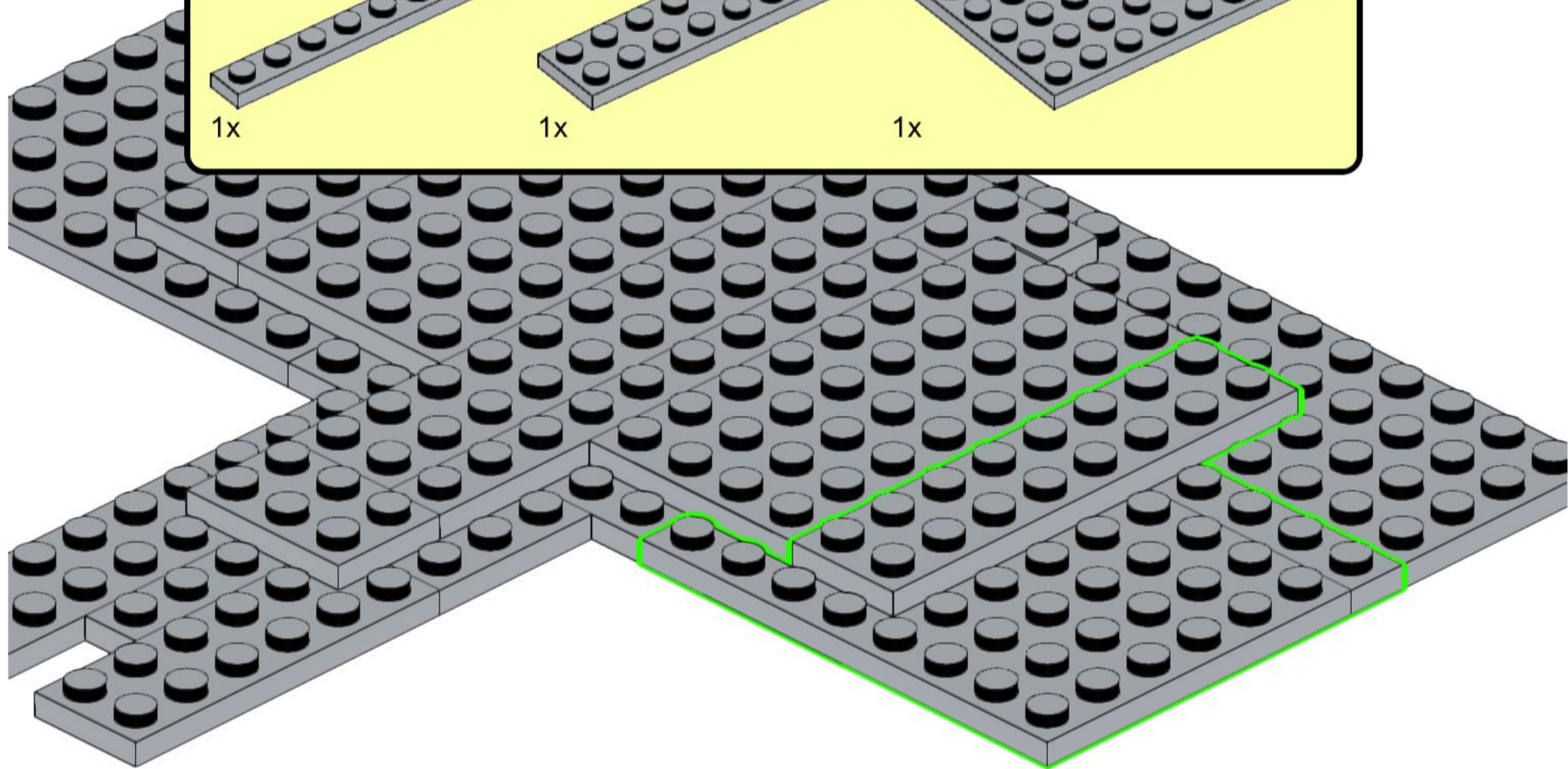
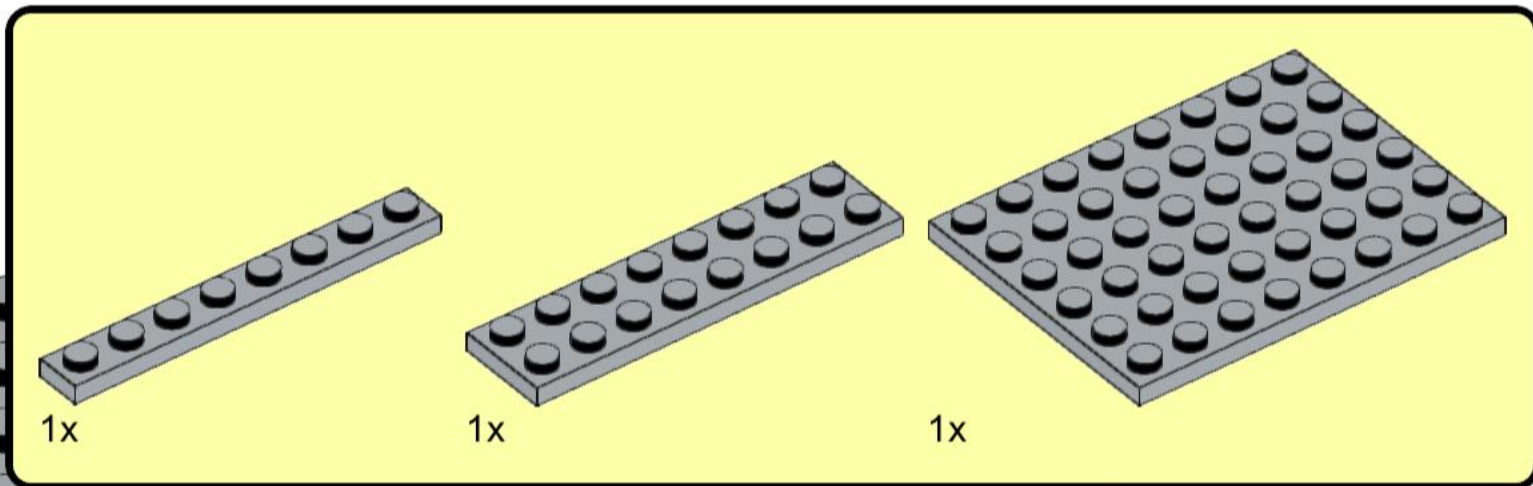

11

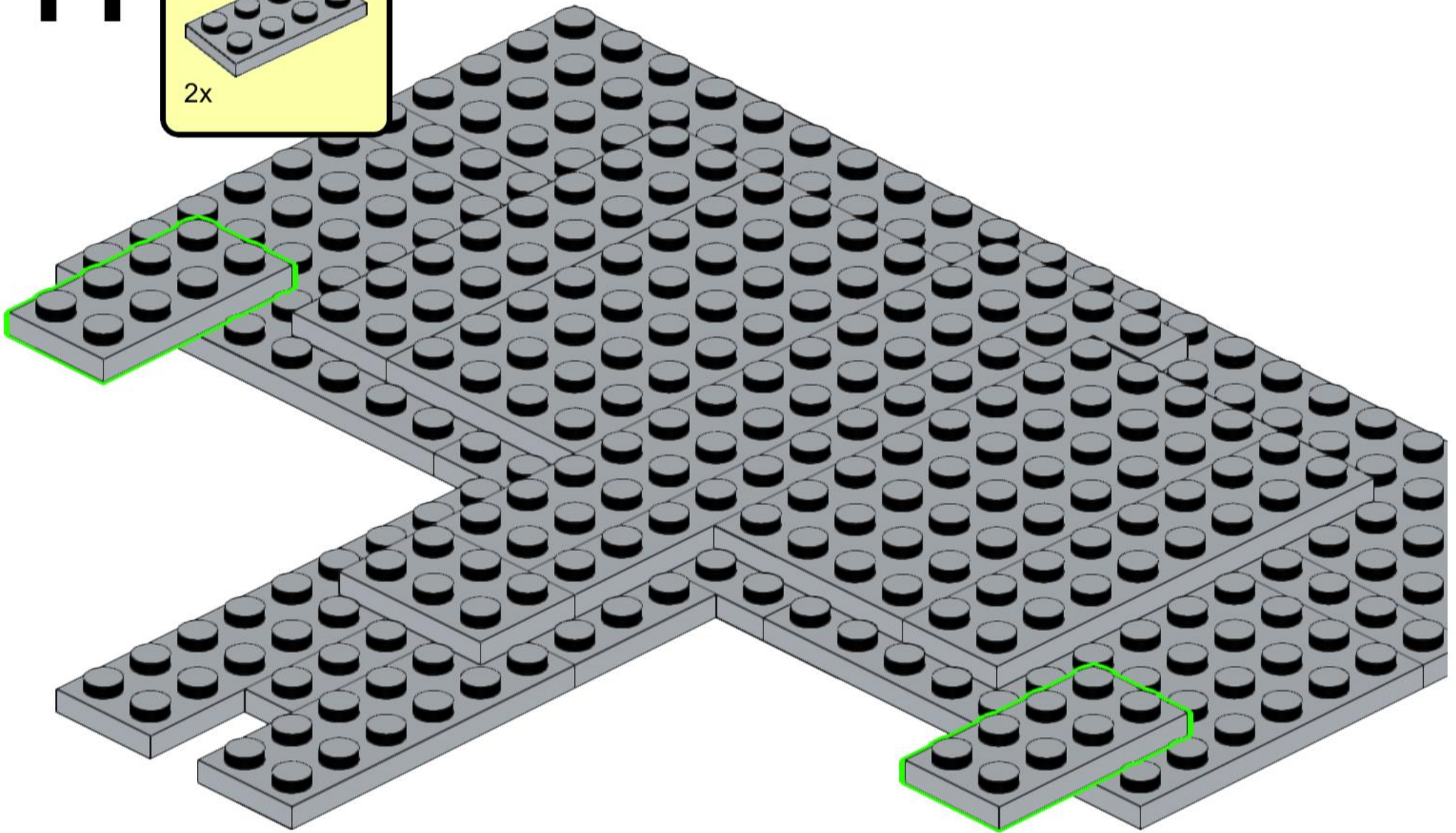
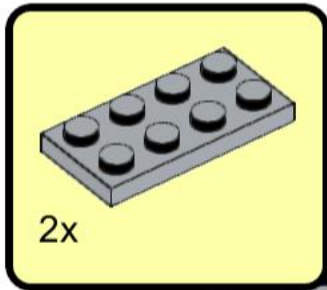

12

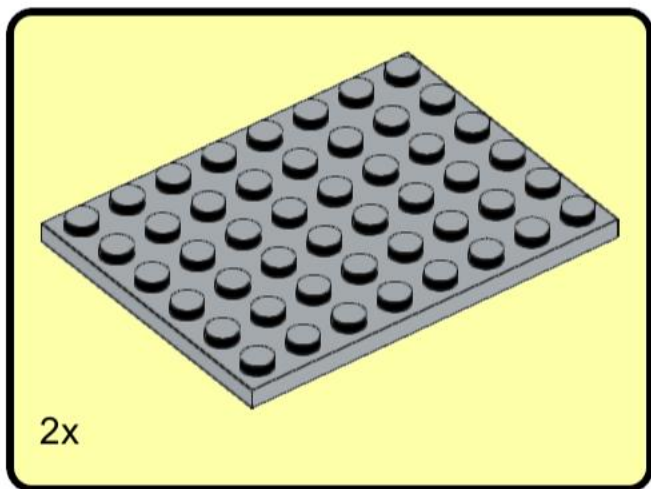
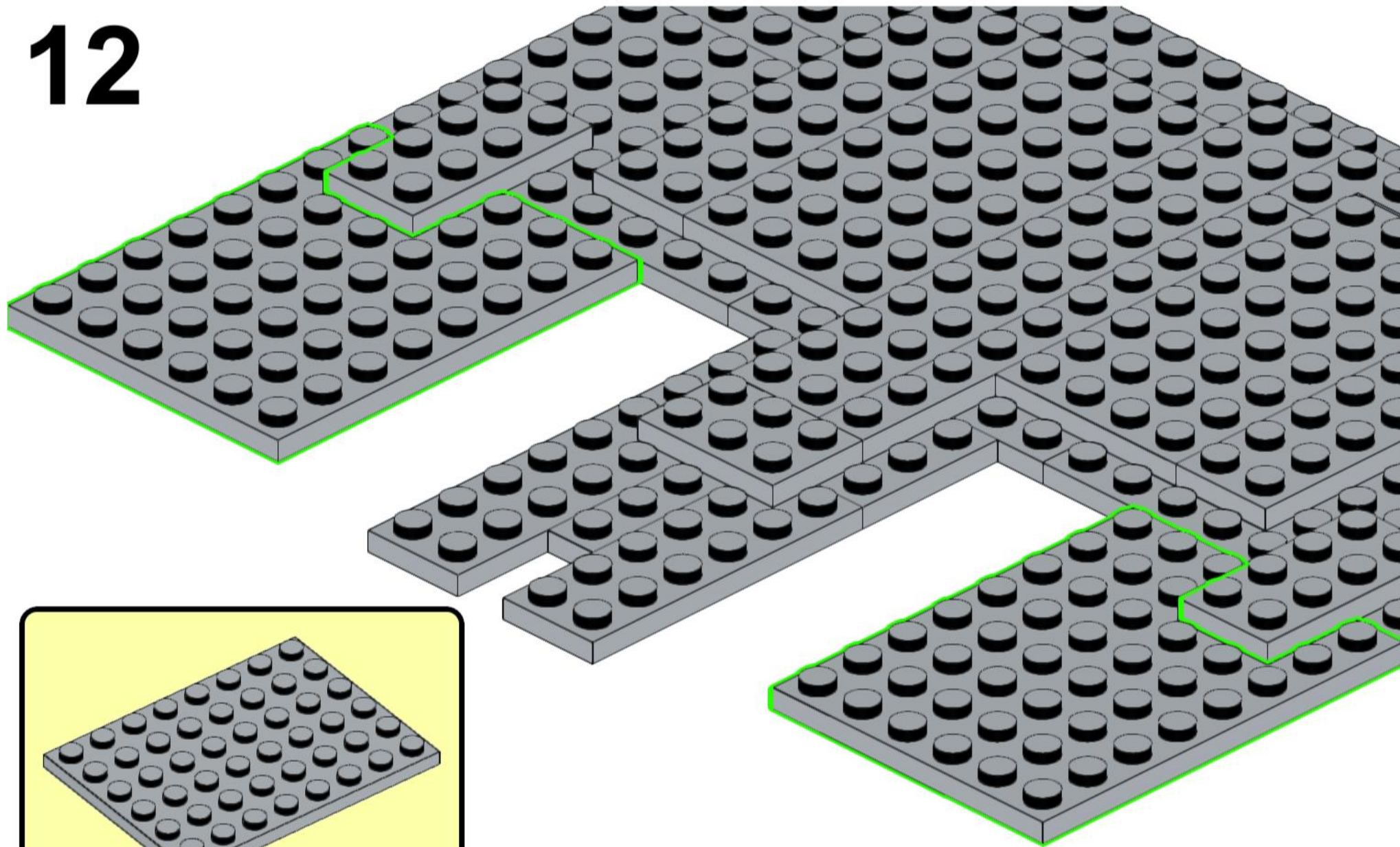

2x

13

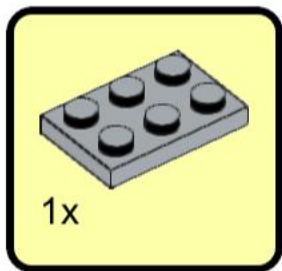
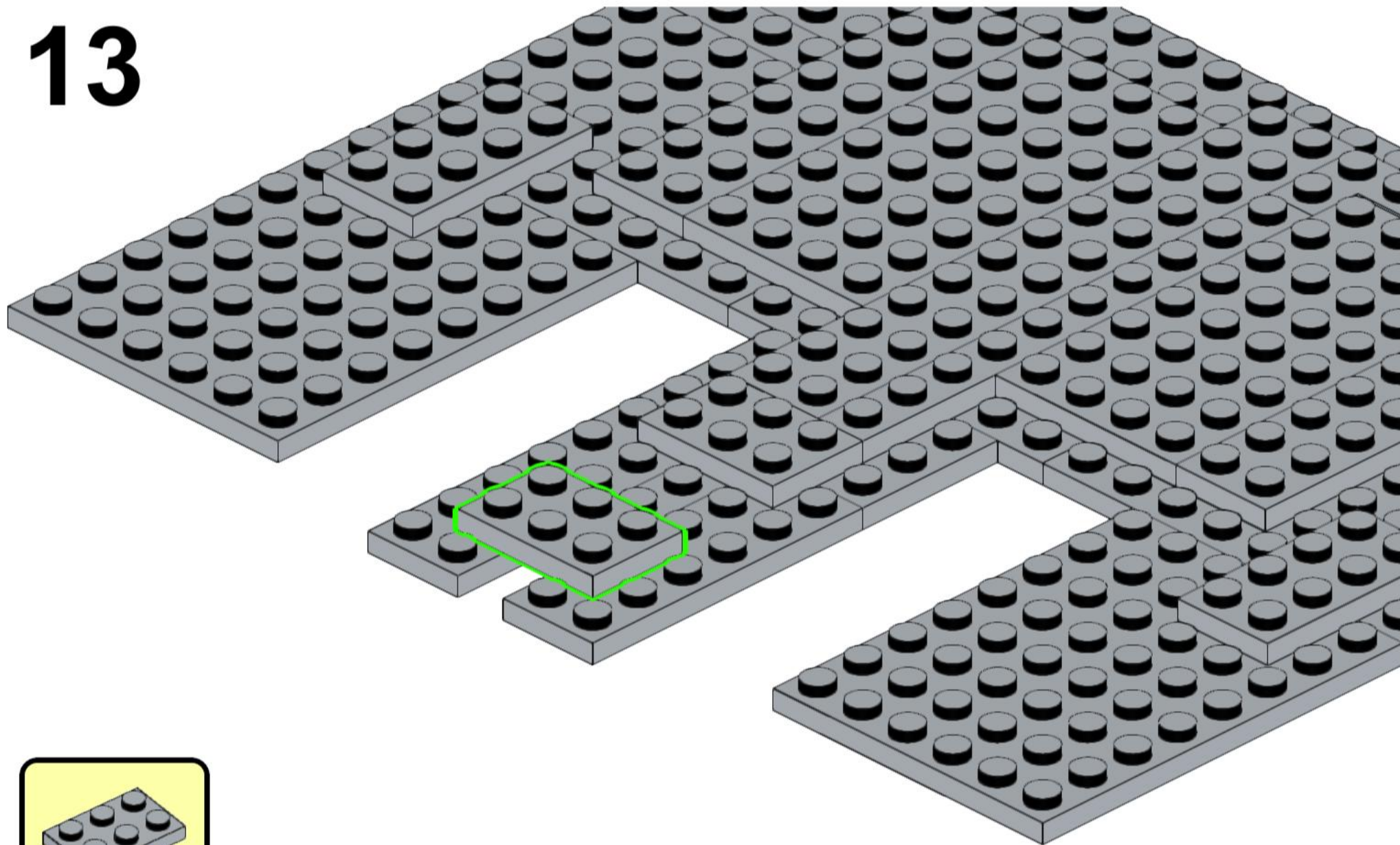

1x

15

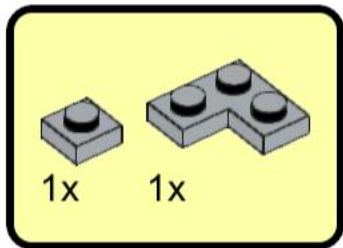
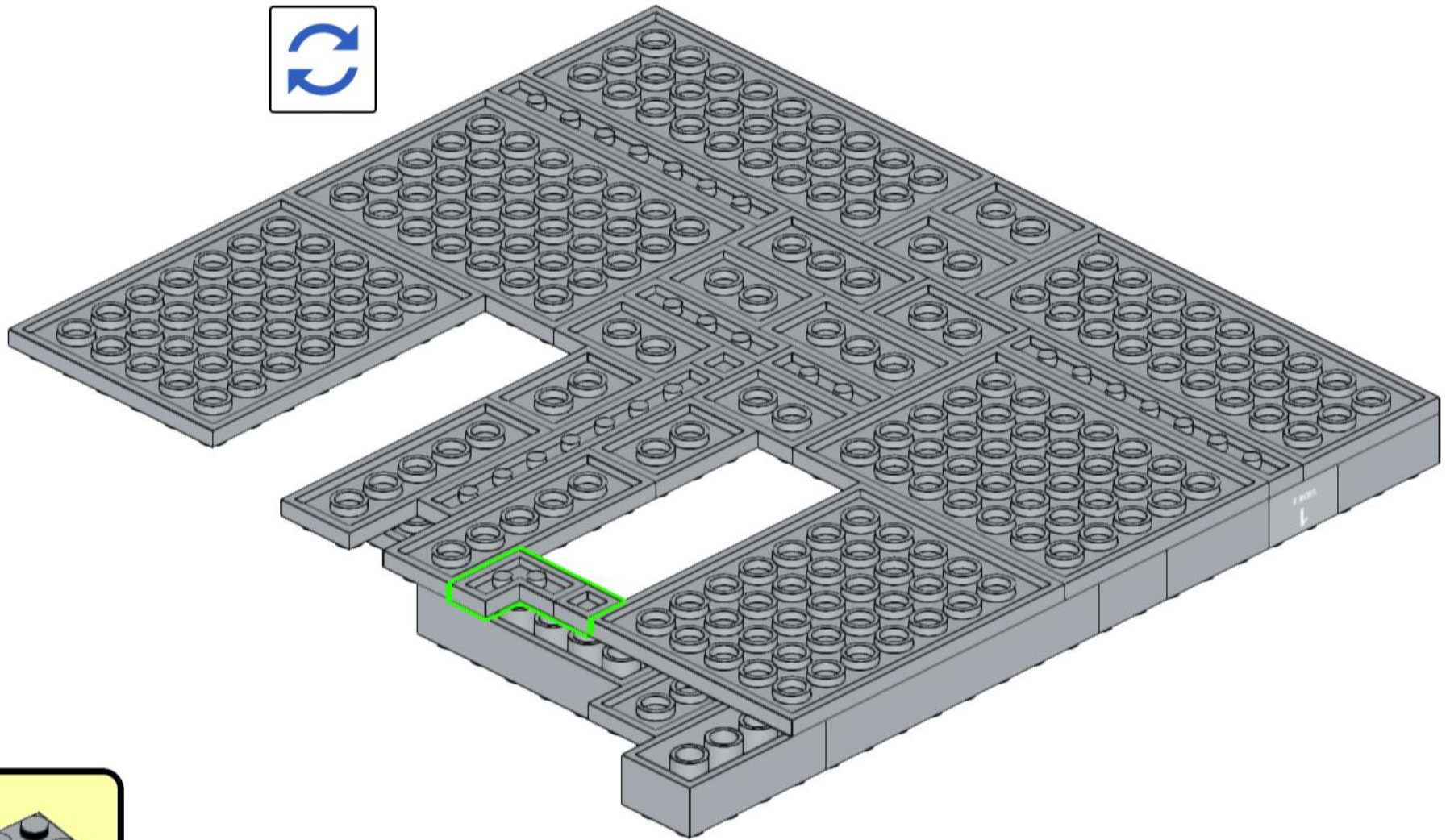

16

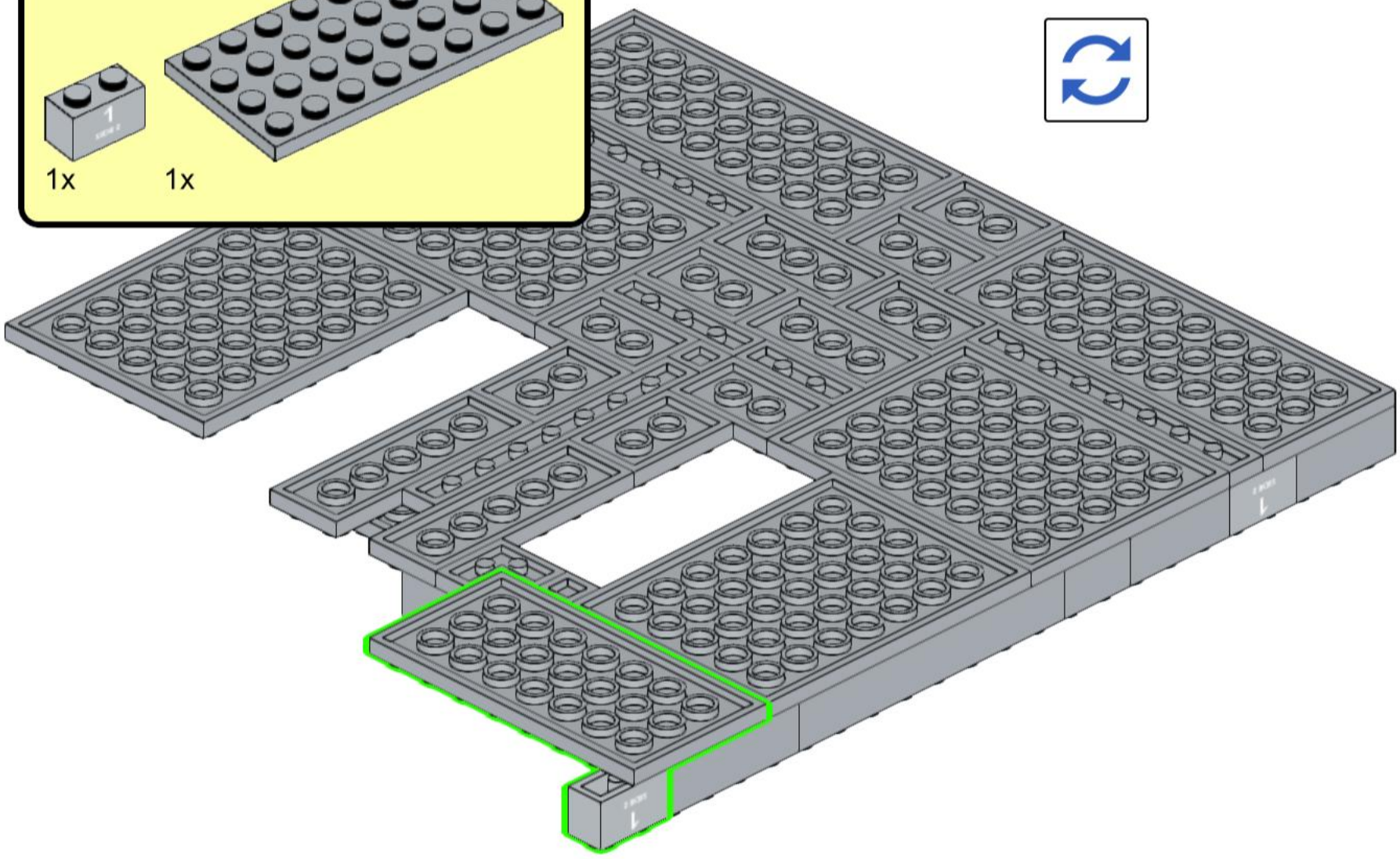
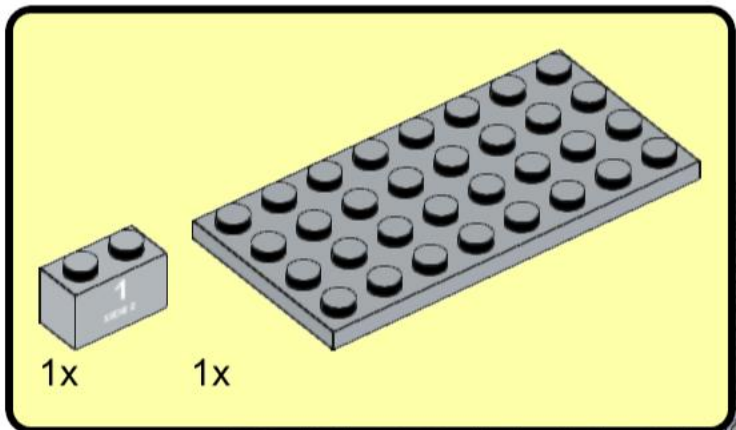

17

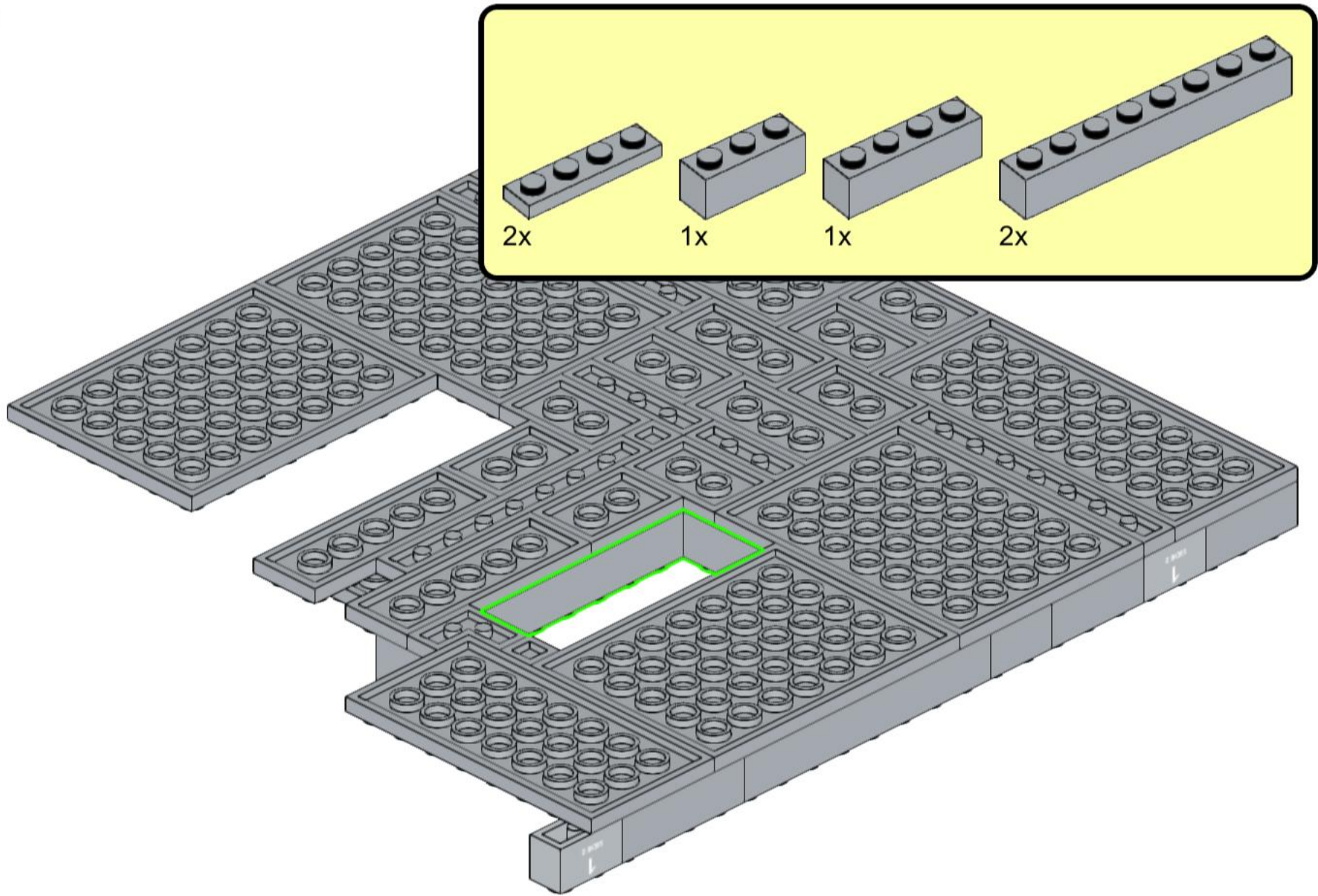

18

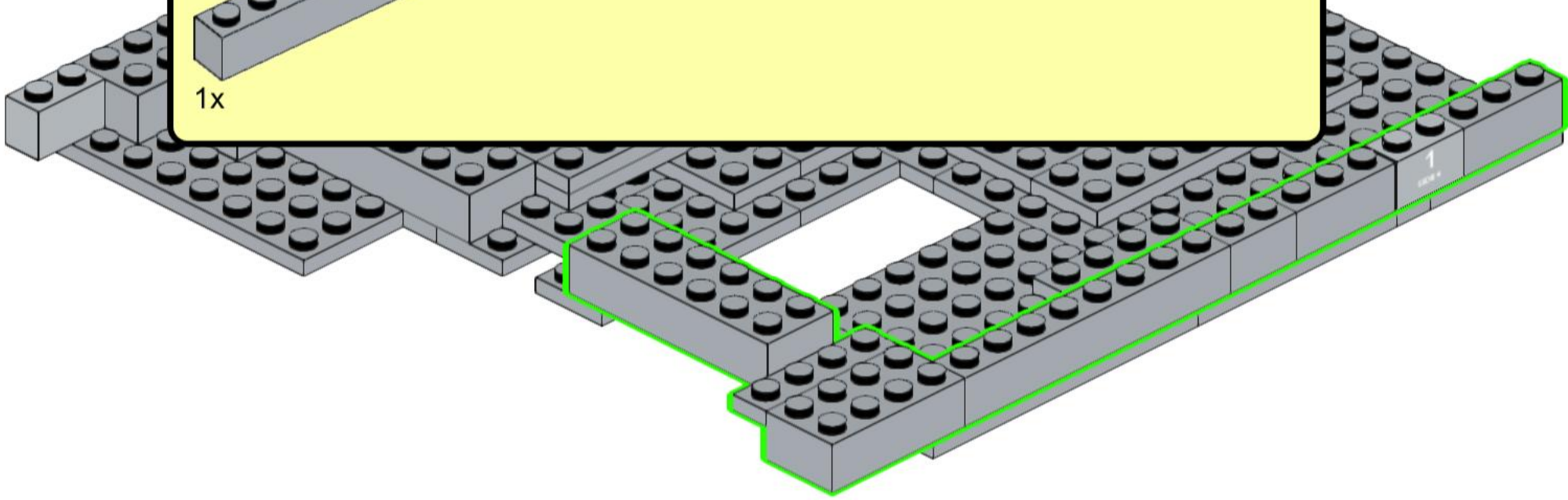
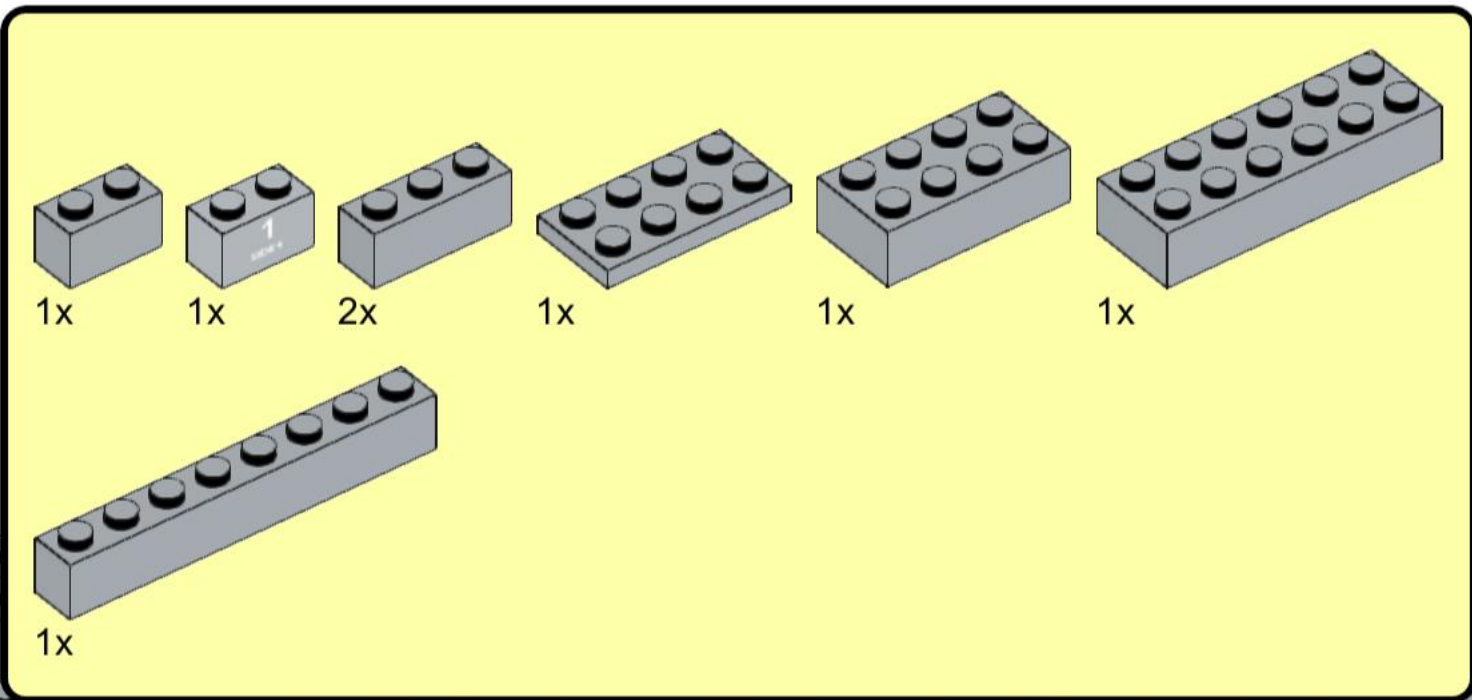

19

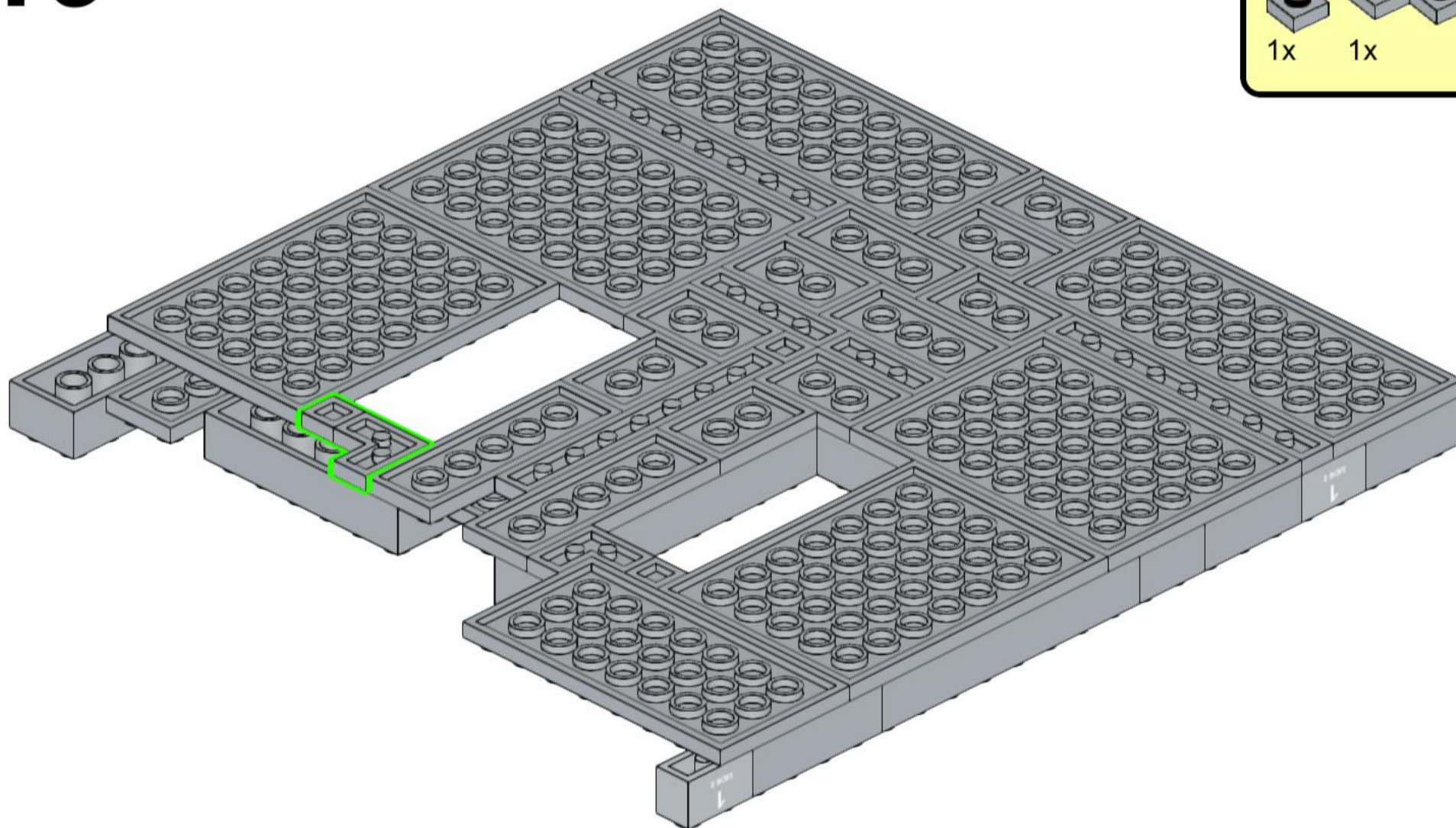
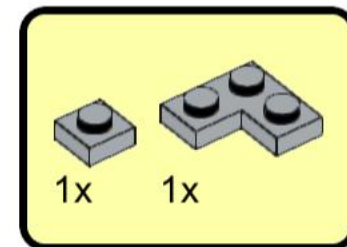

20

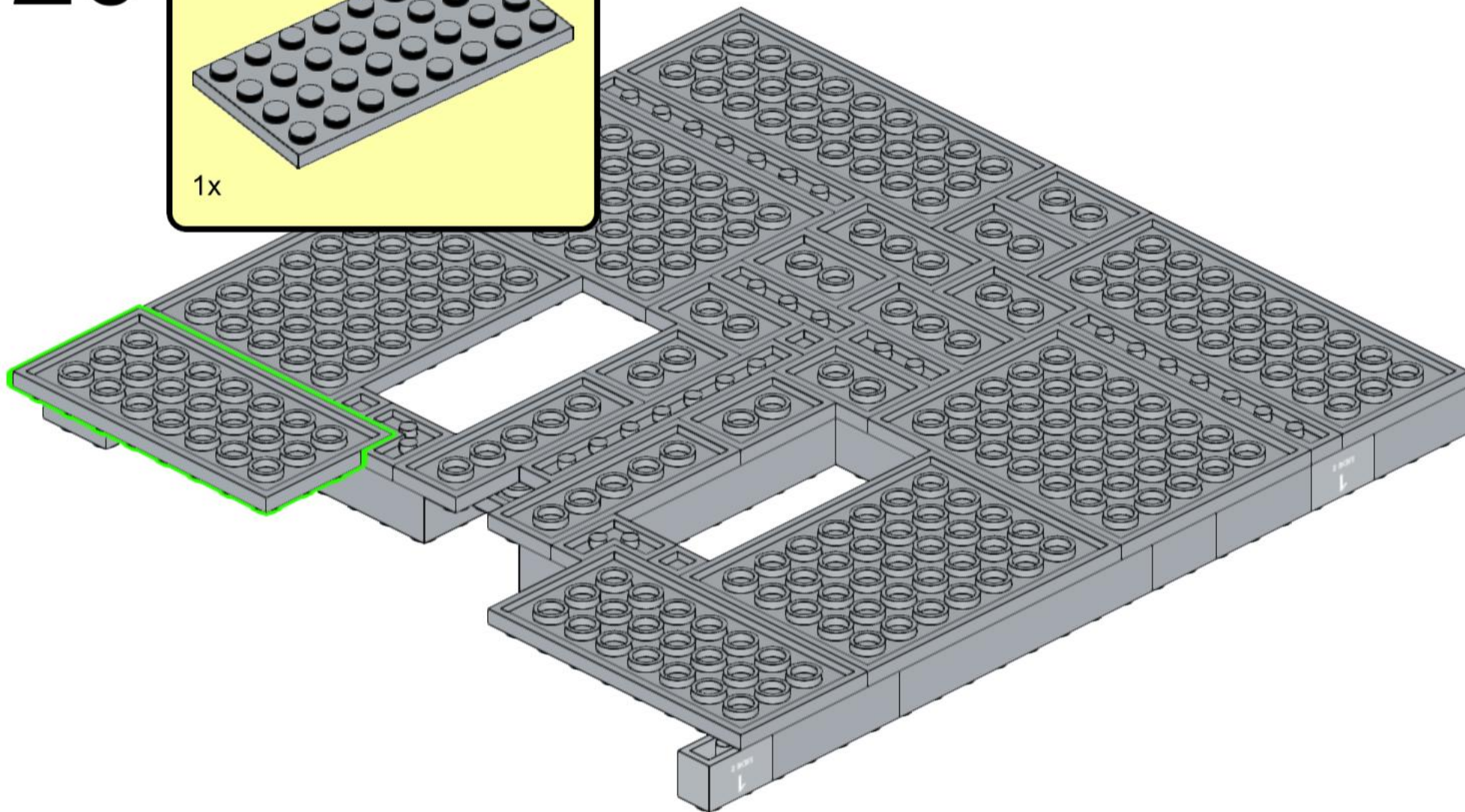
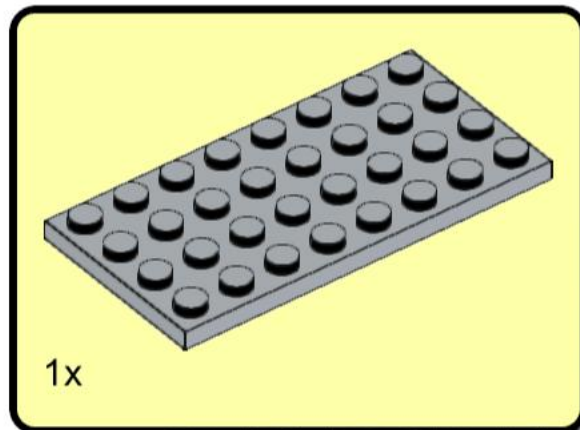

21

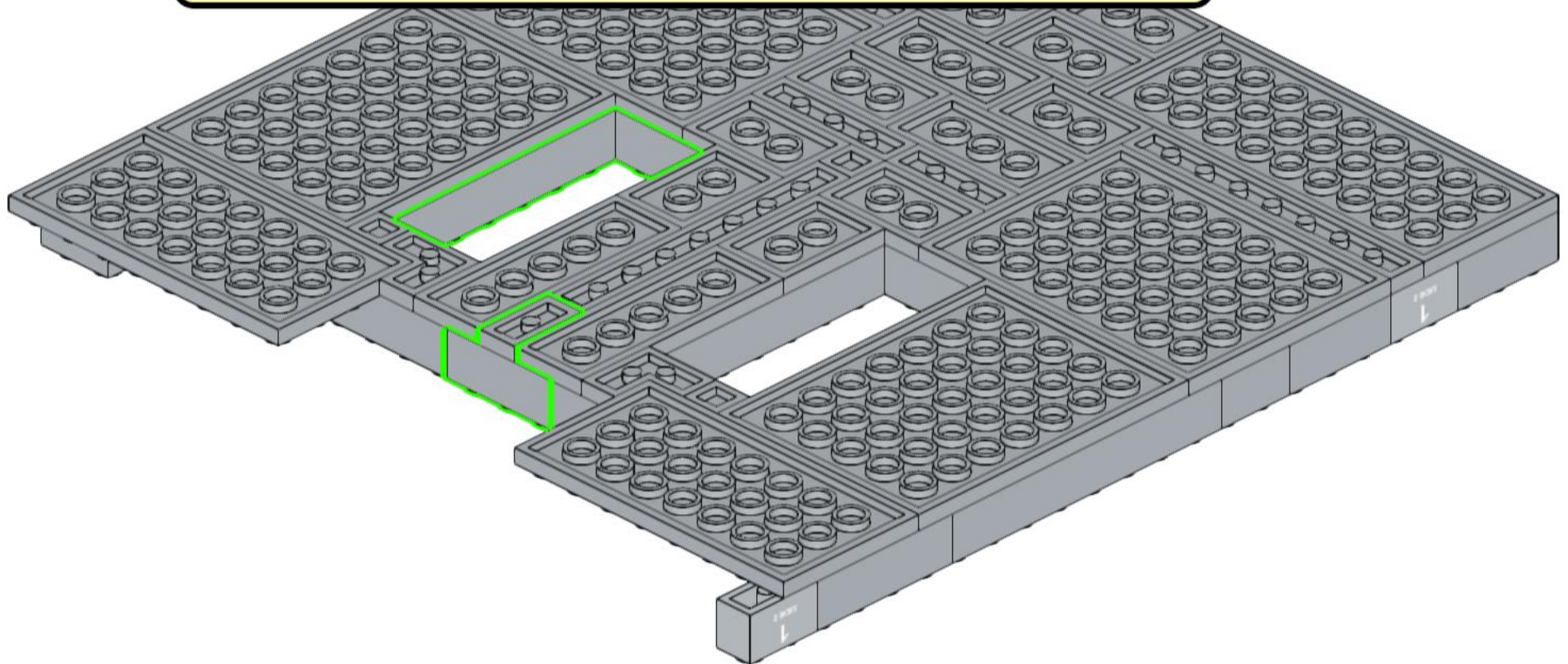
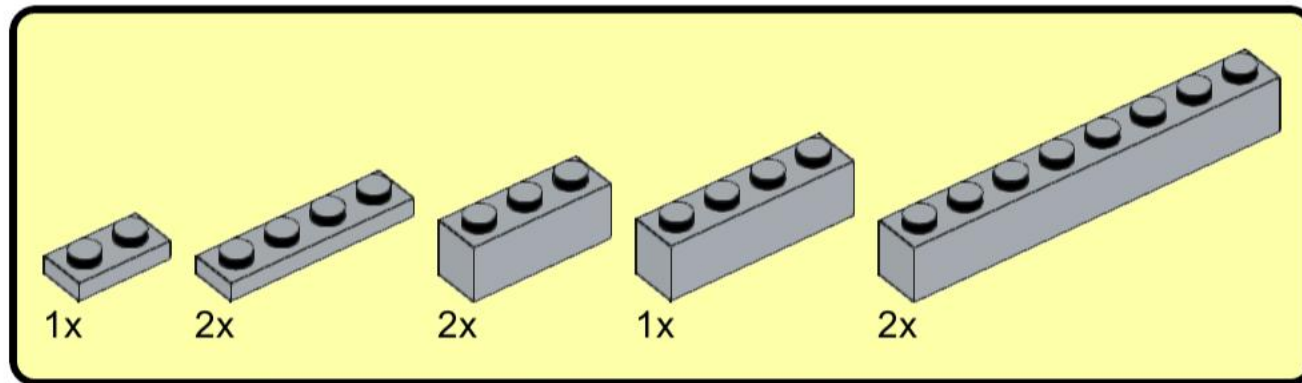

22

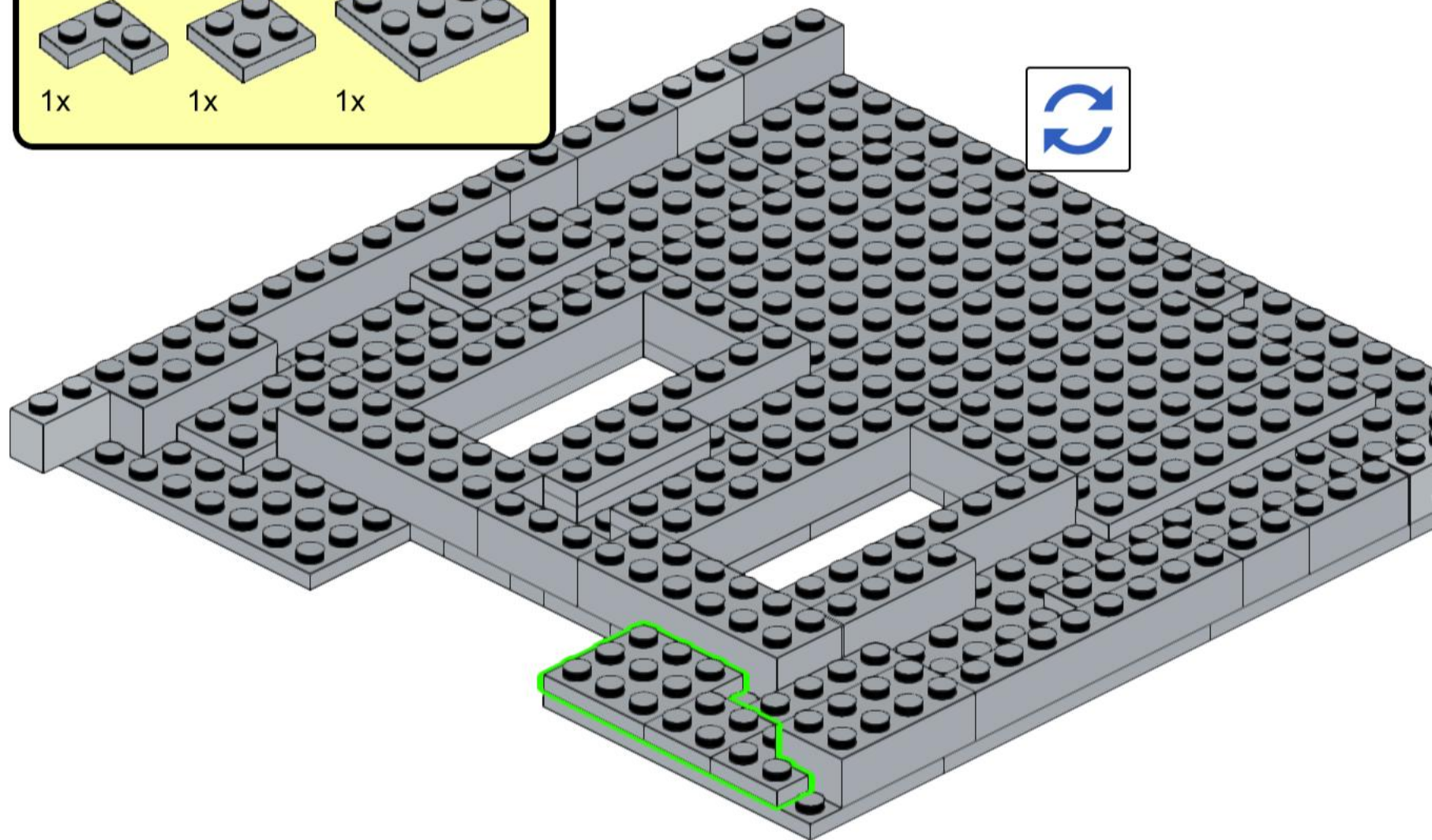
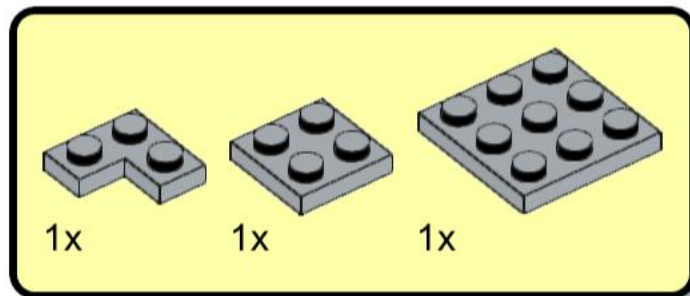

23

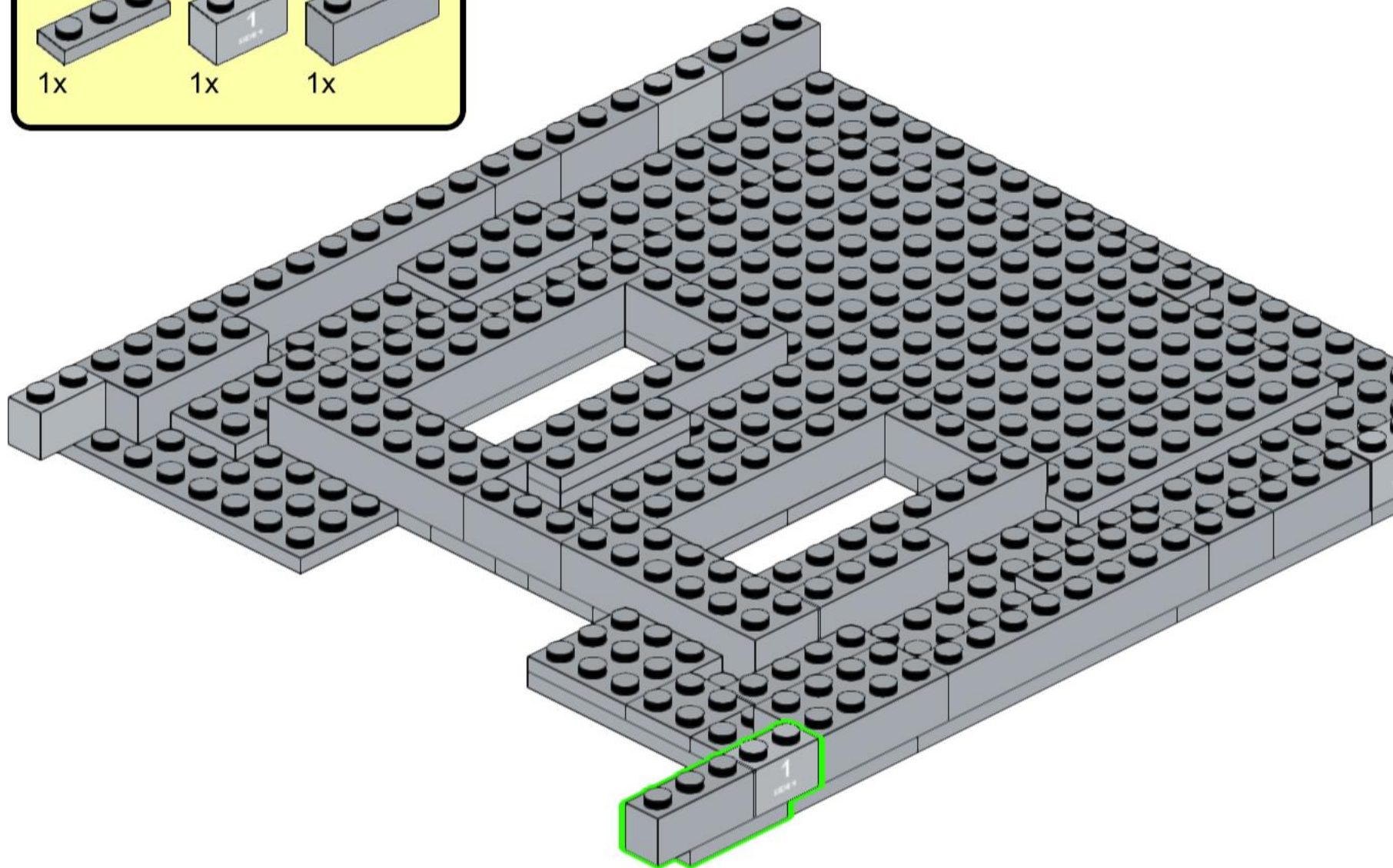
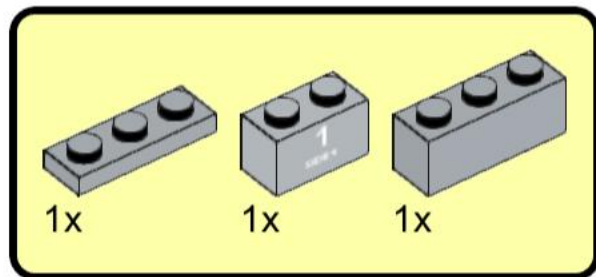

24

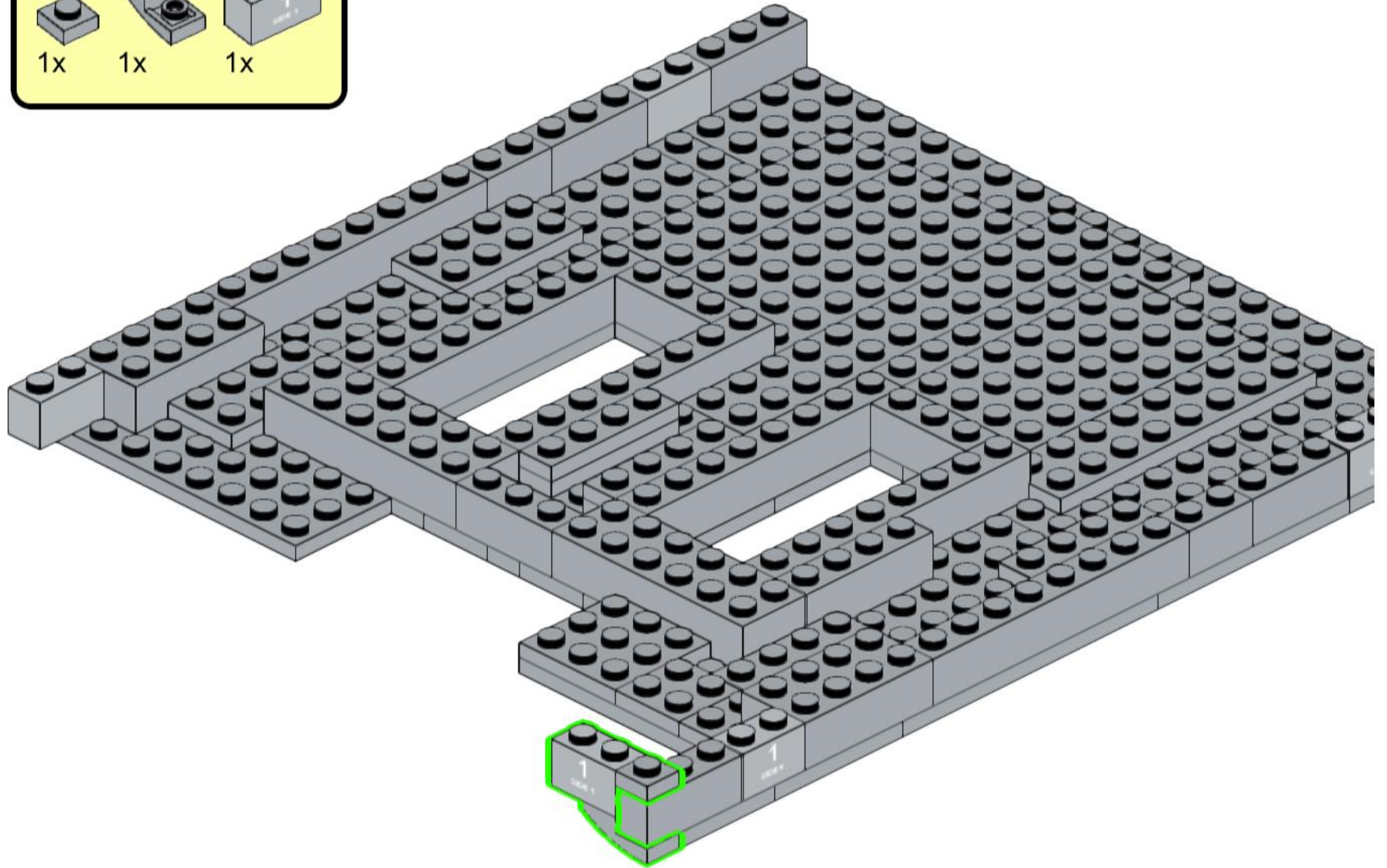
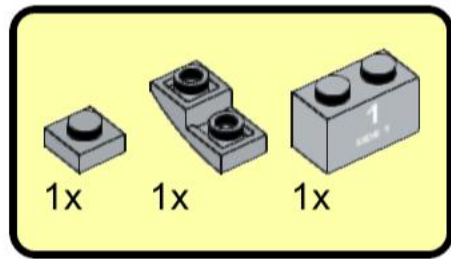

25

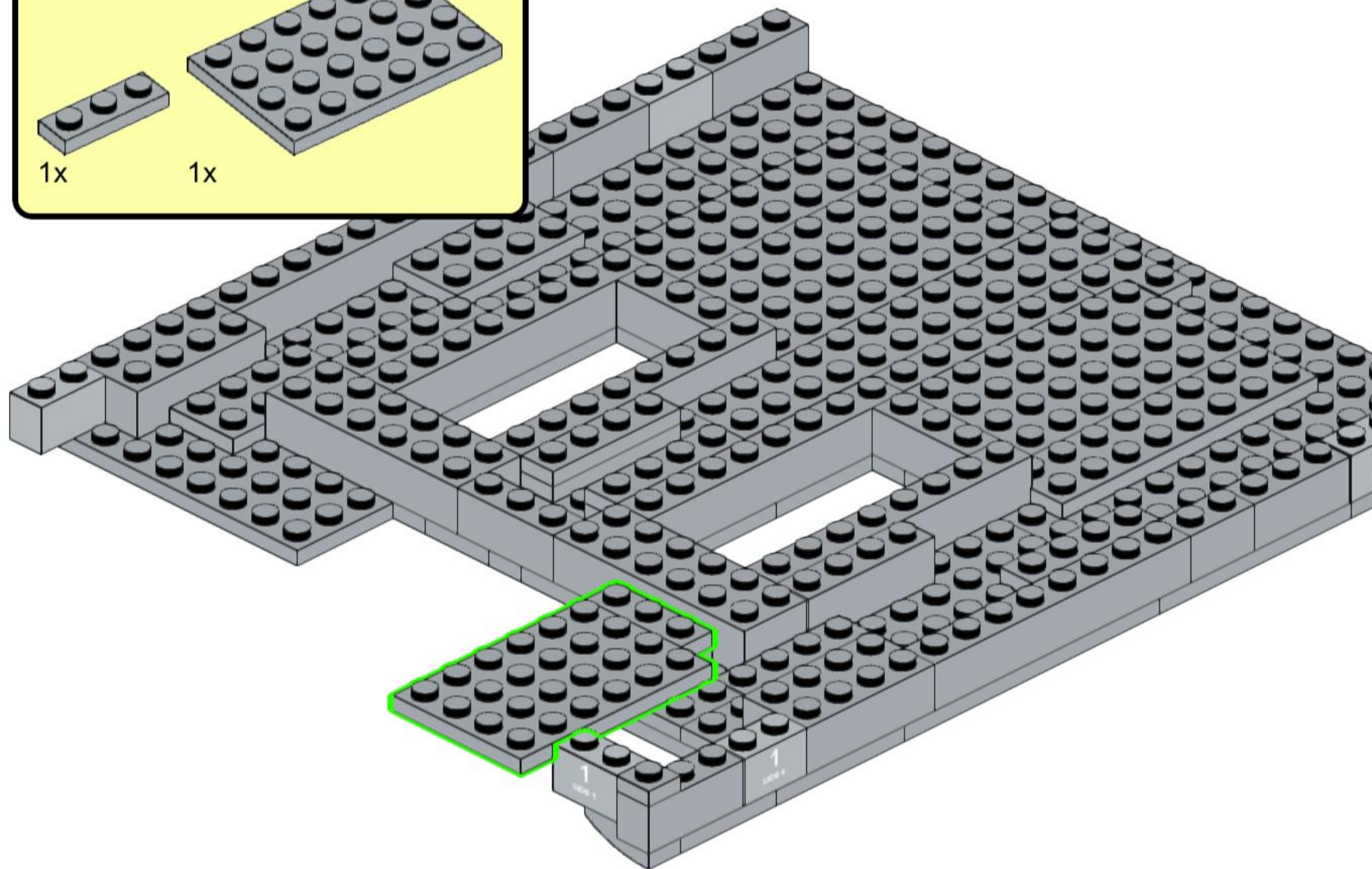
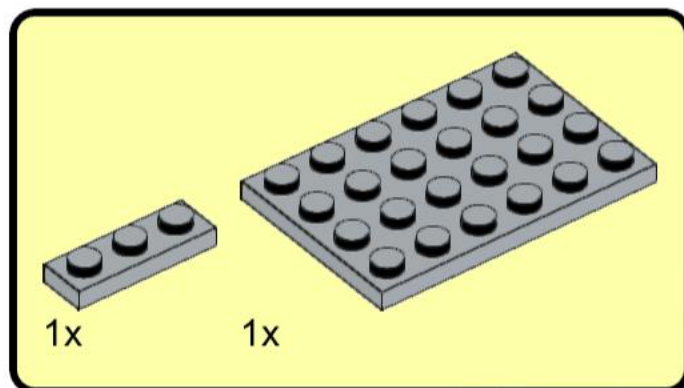

26

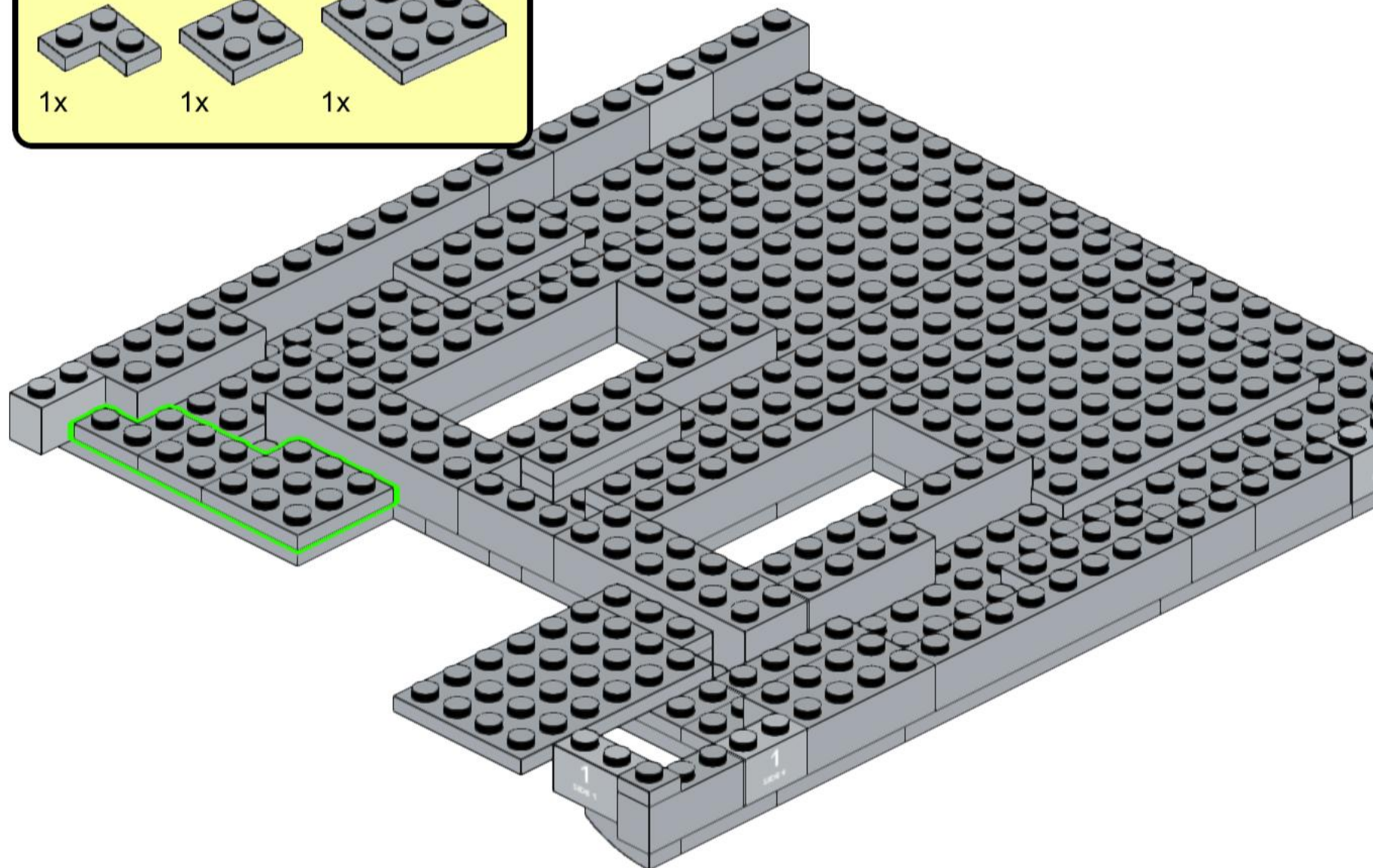
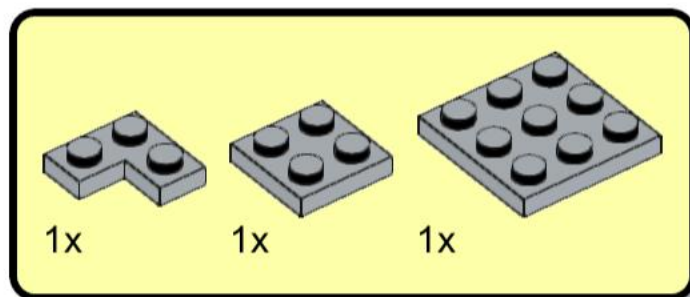

27

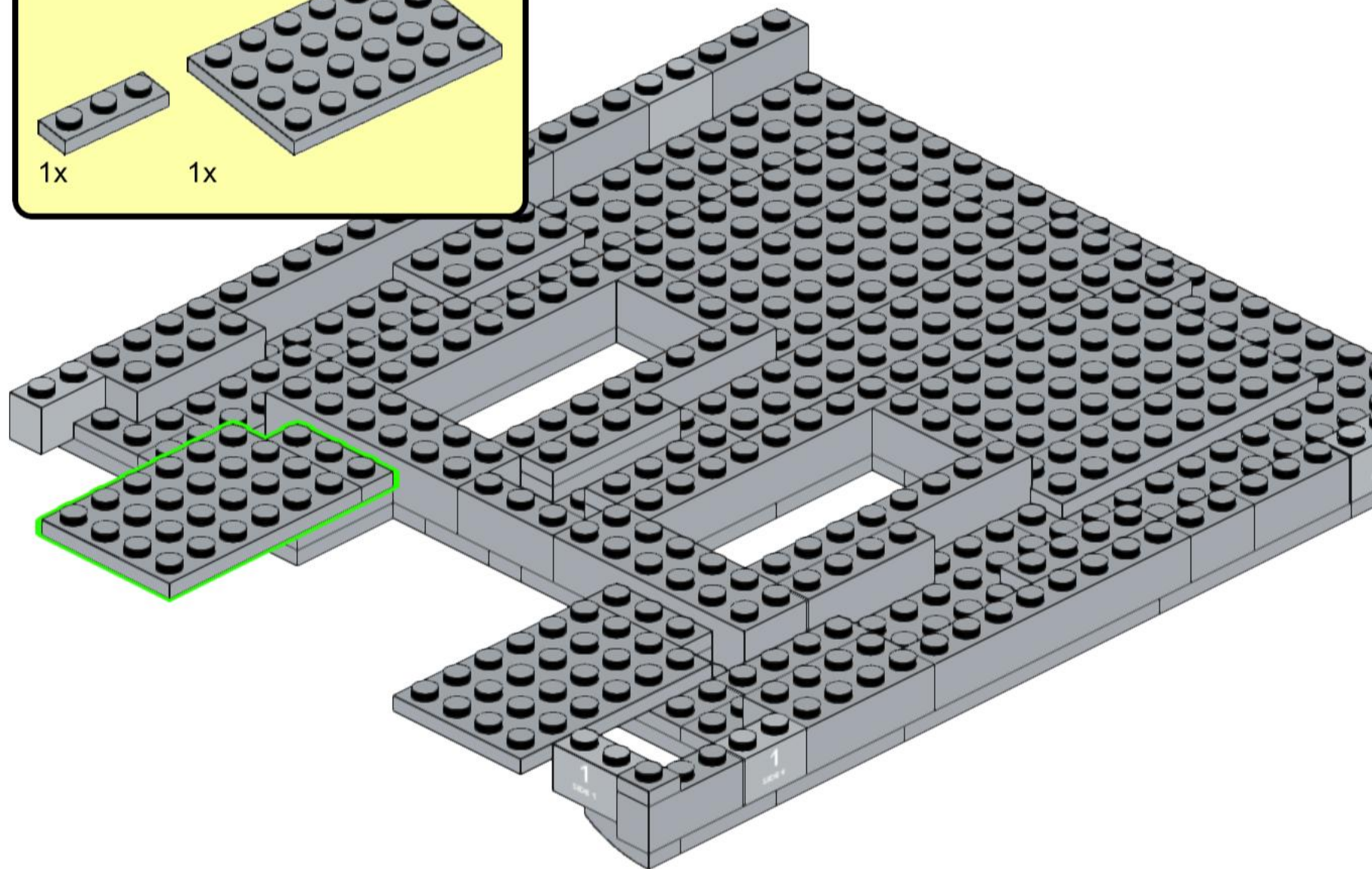
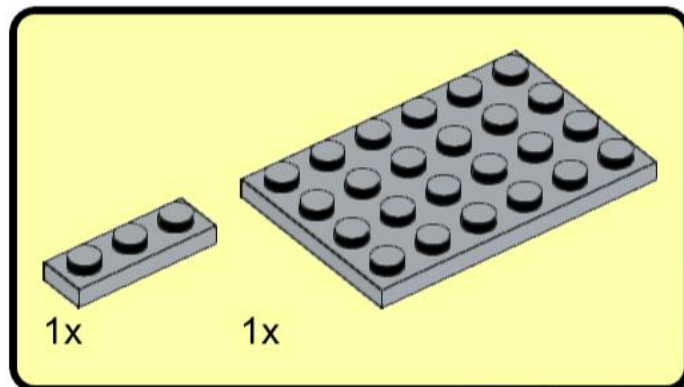

28

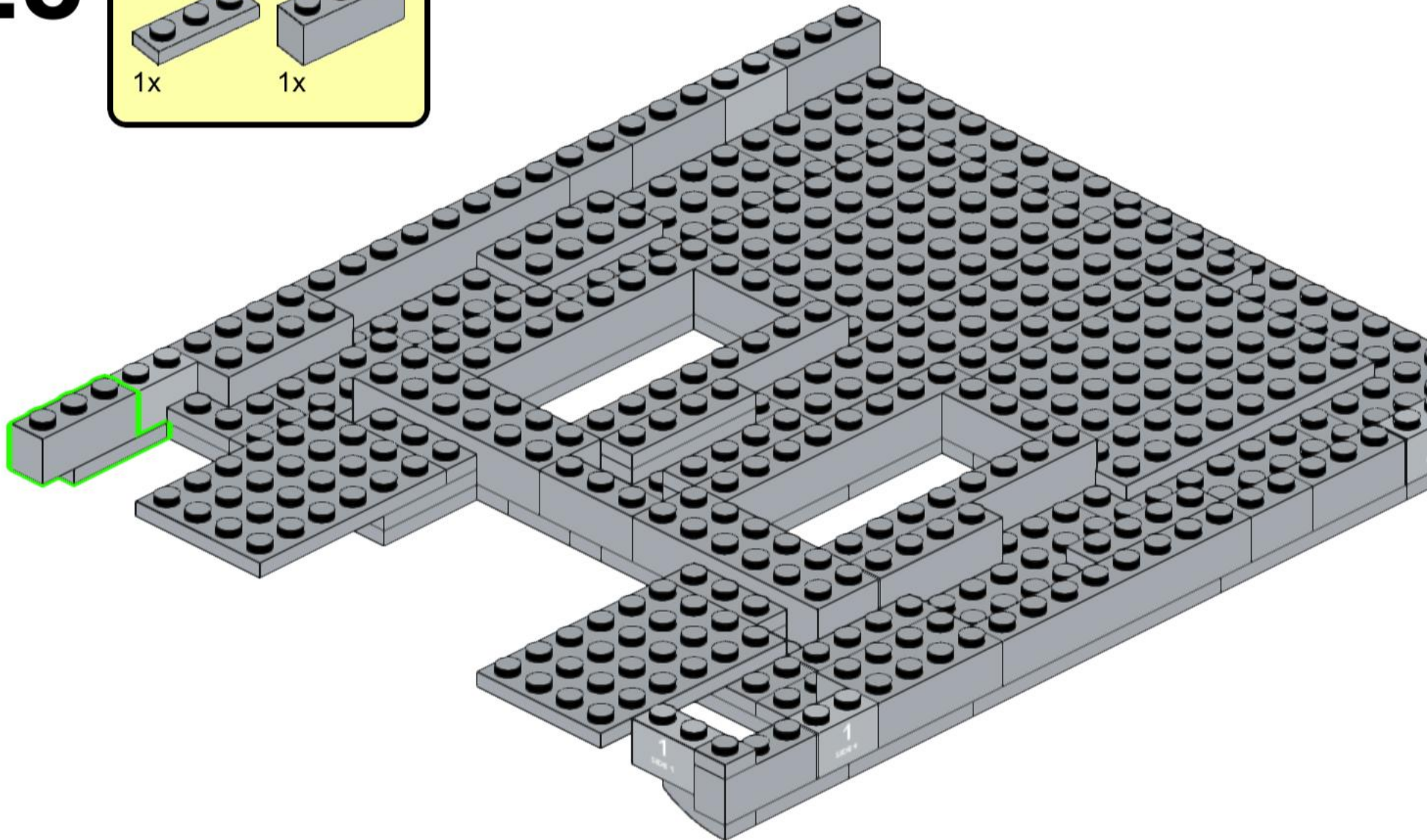
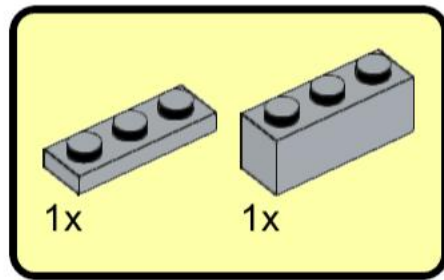

29

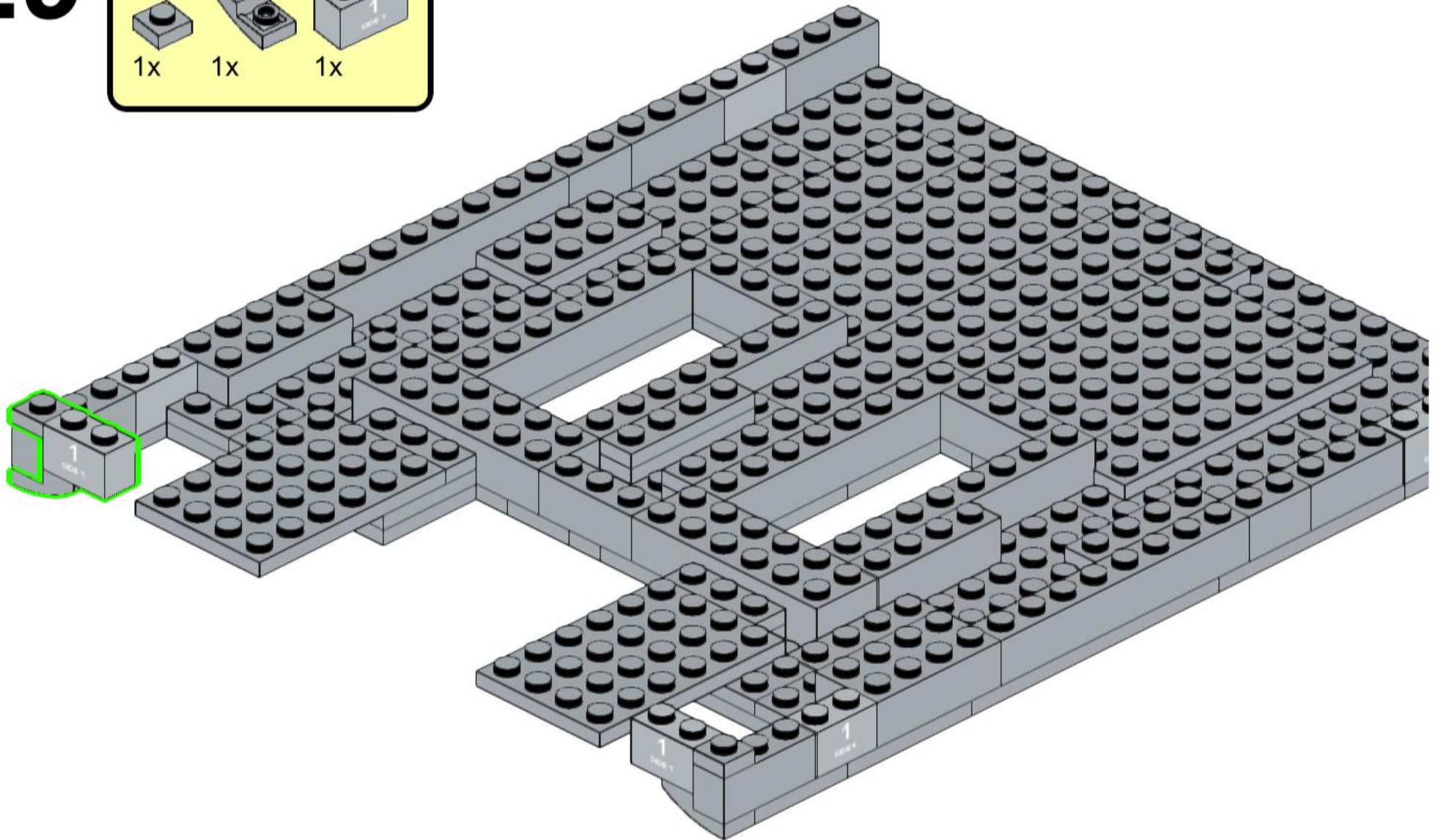
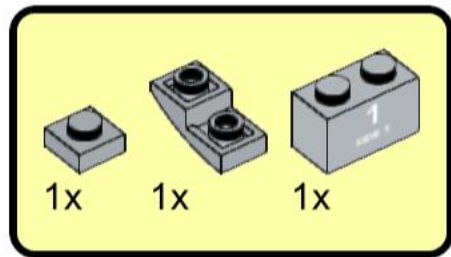

31

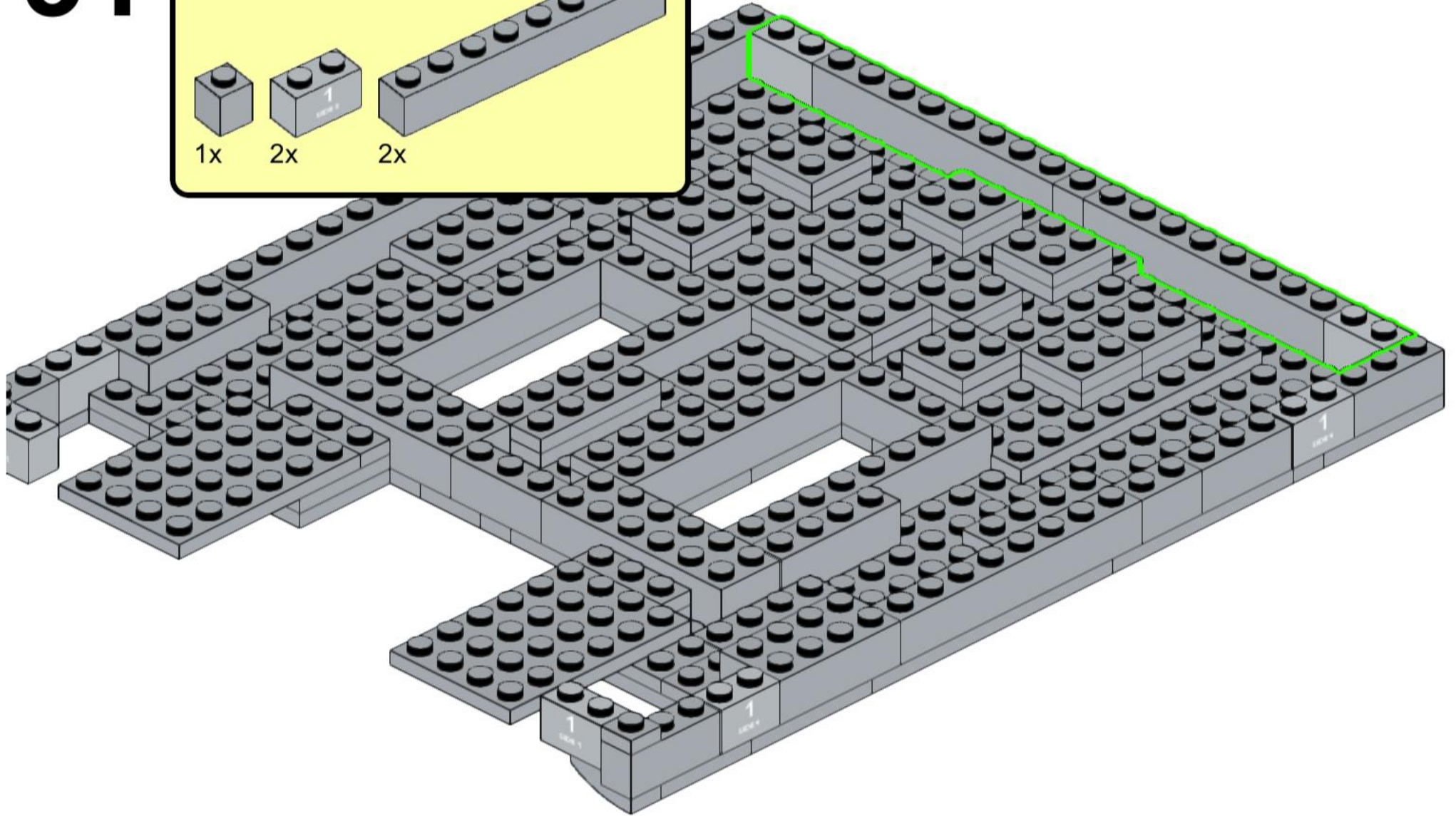
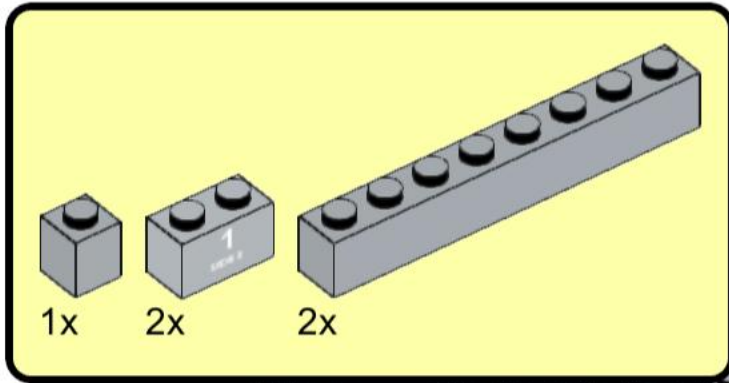

32

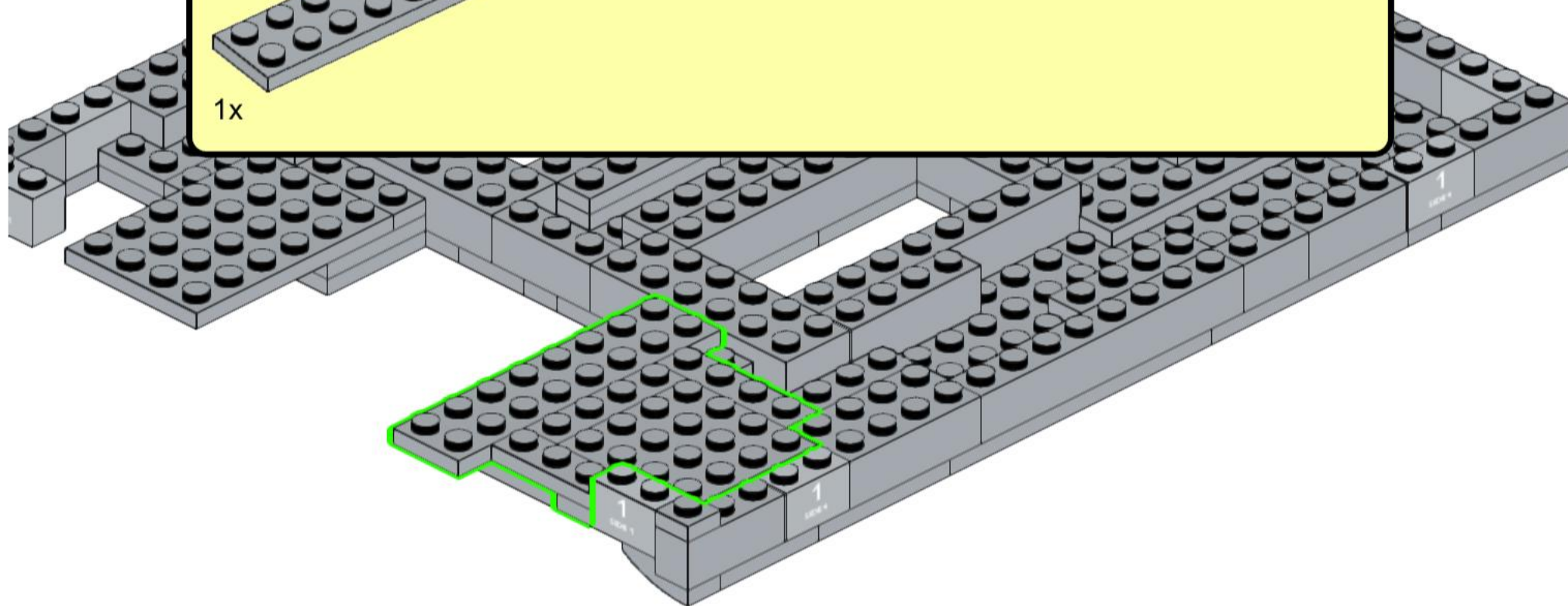
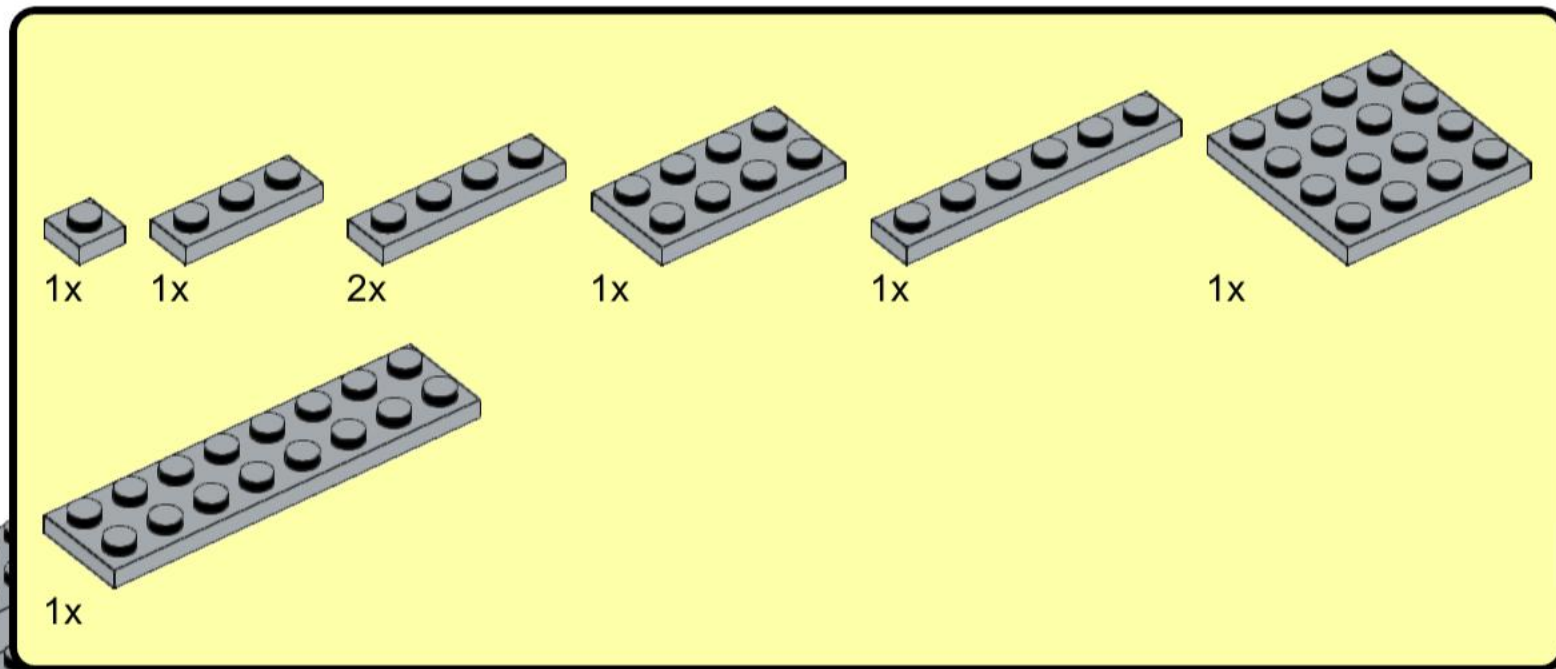

33

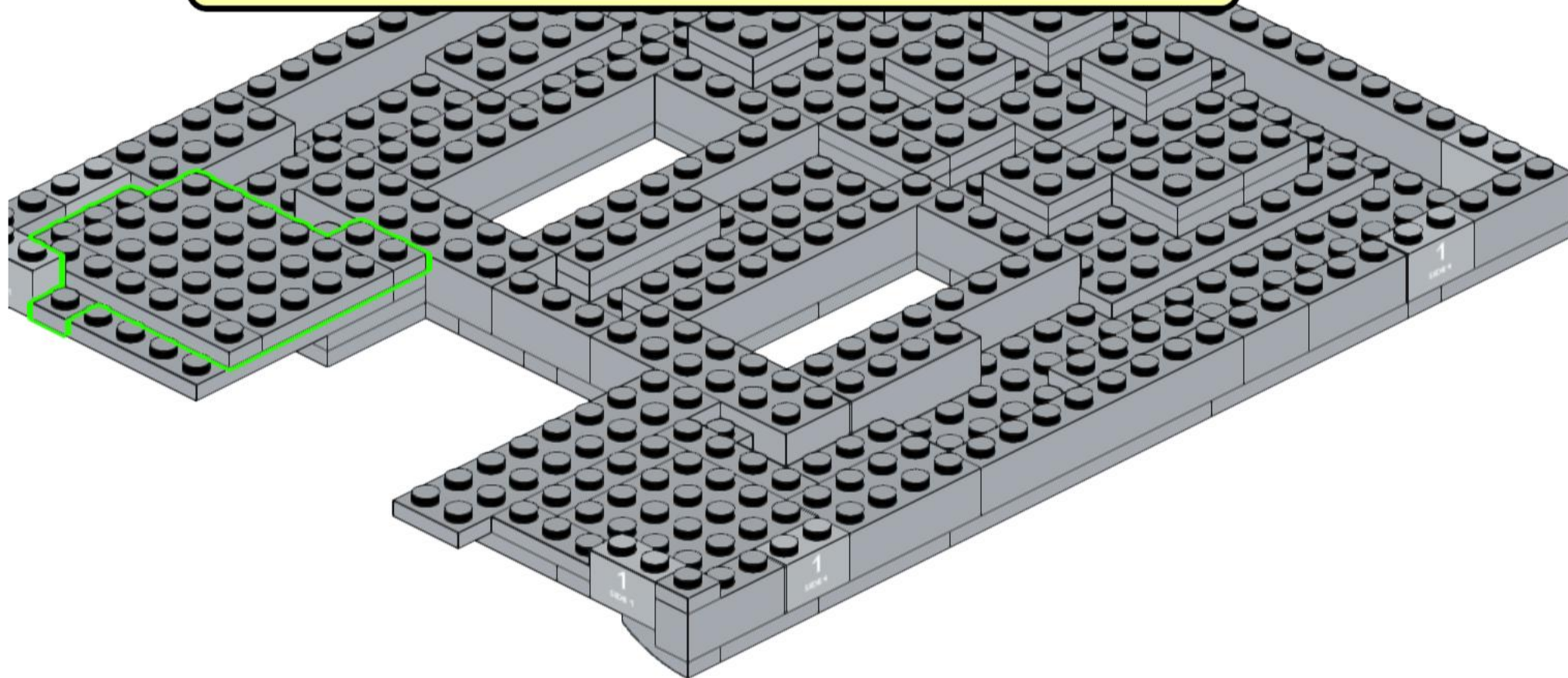
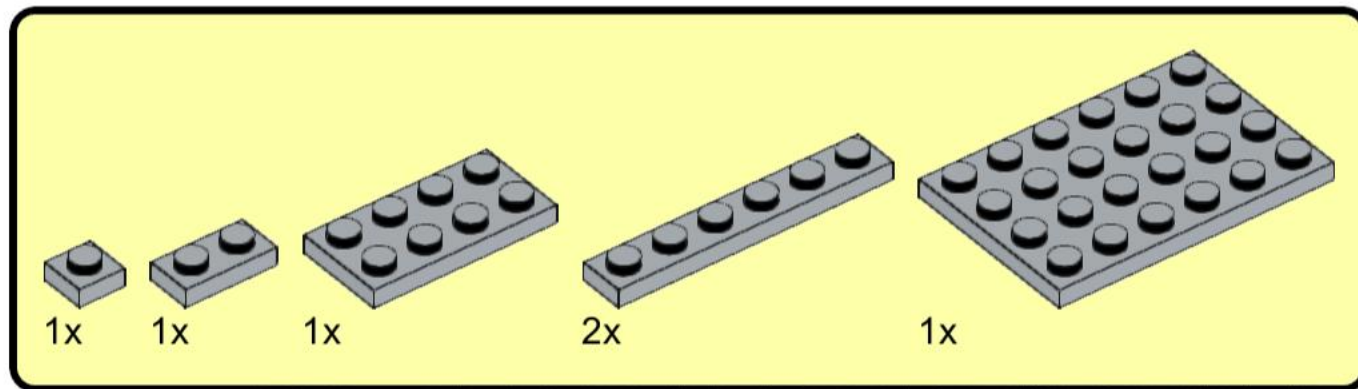

34

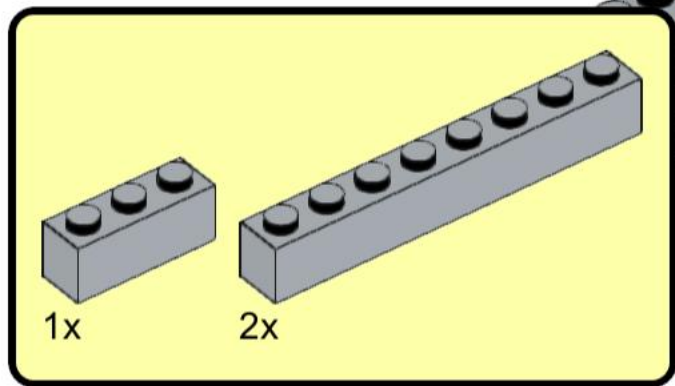
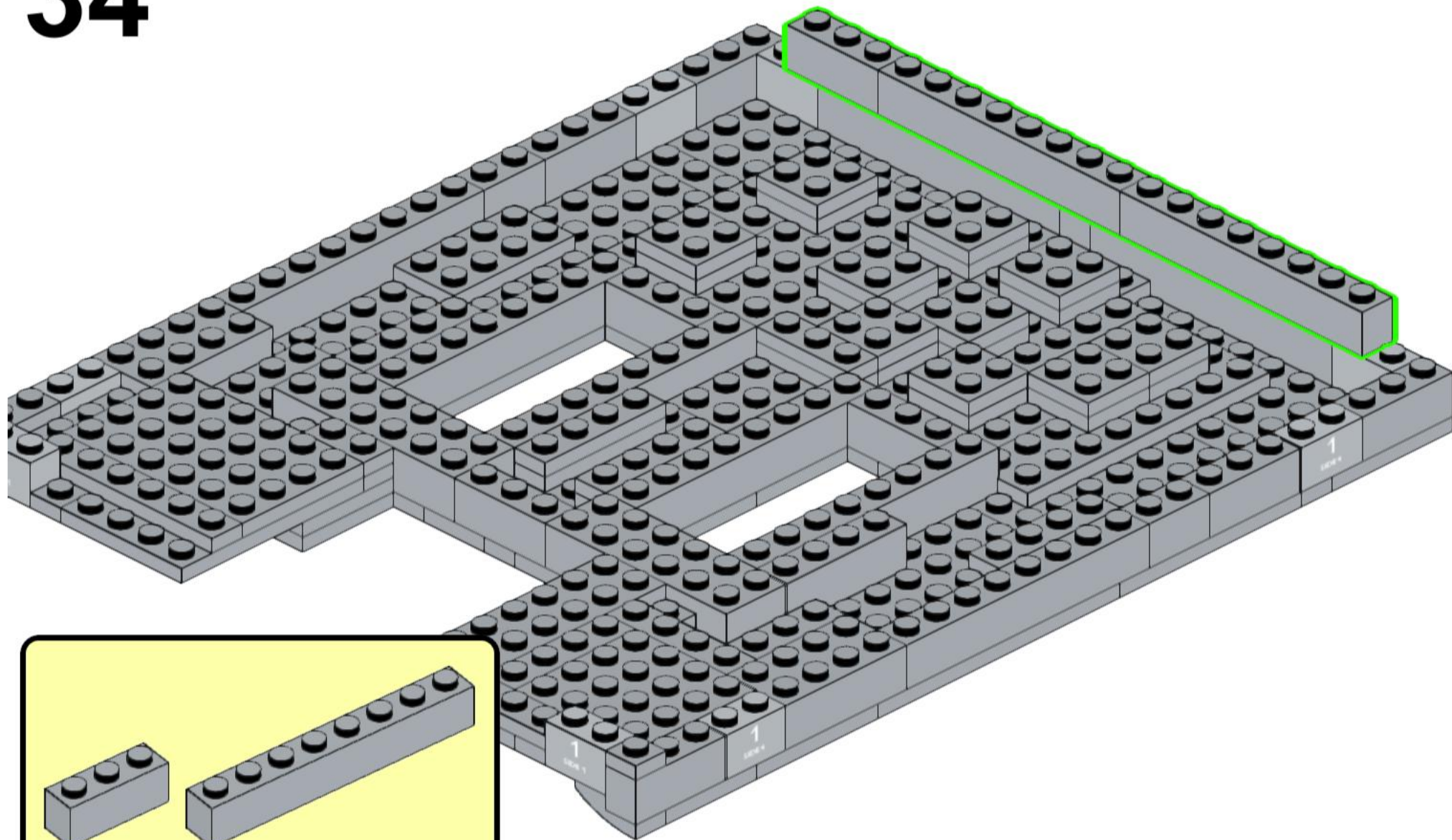

35

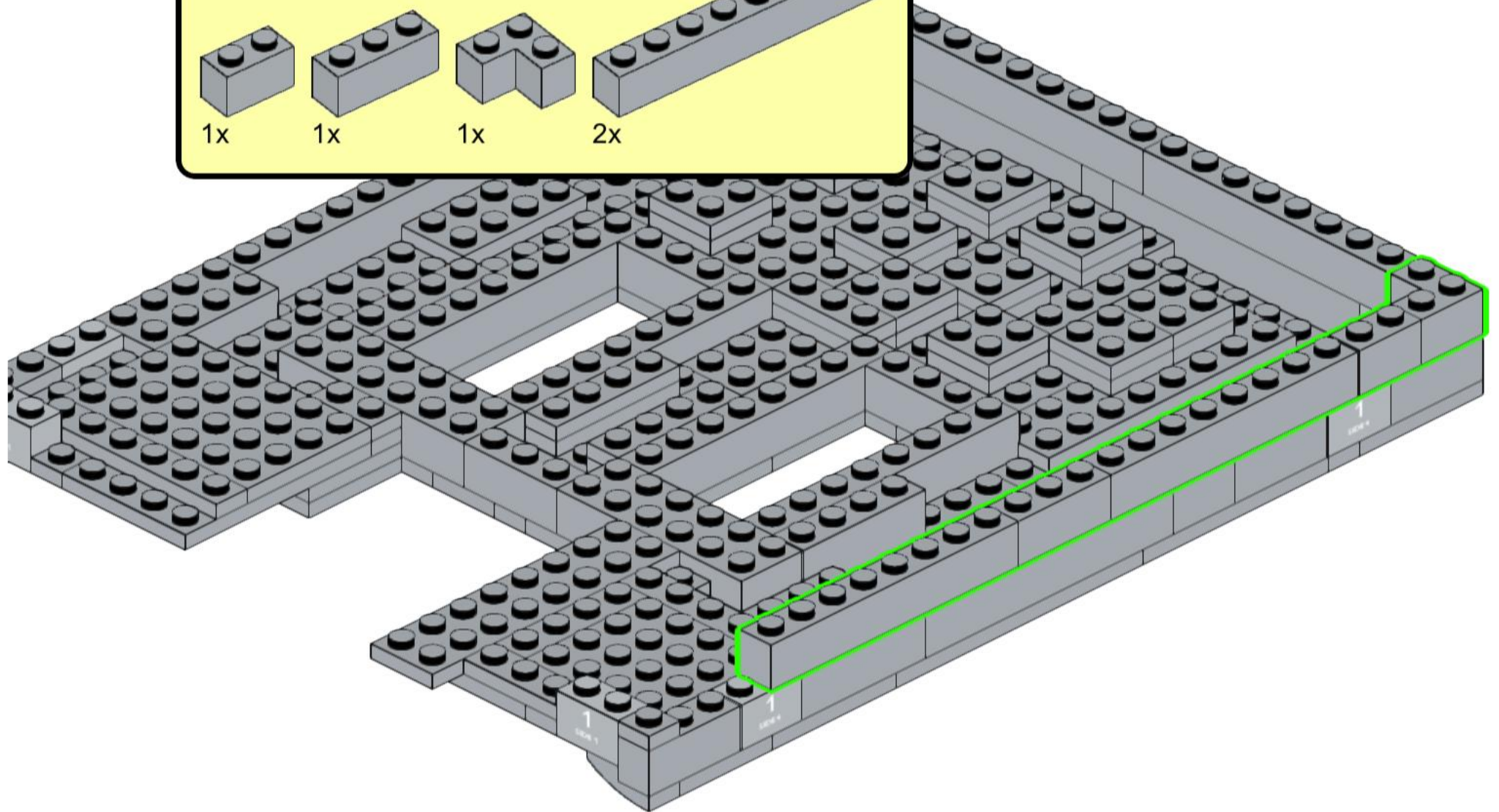
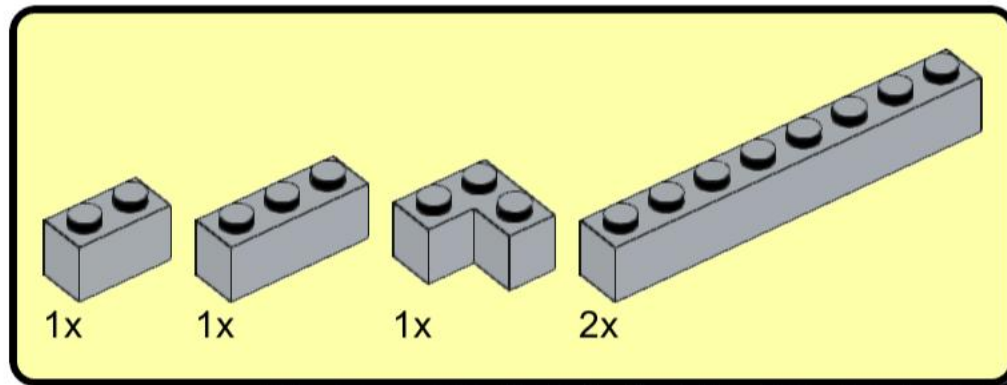

36

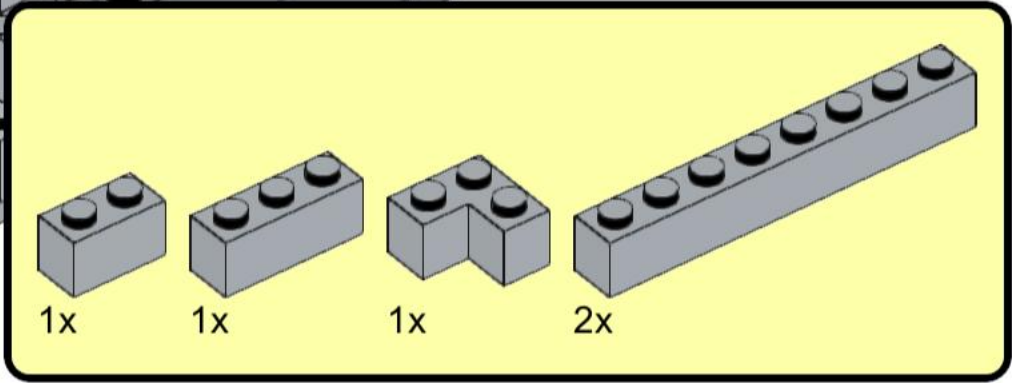
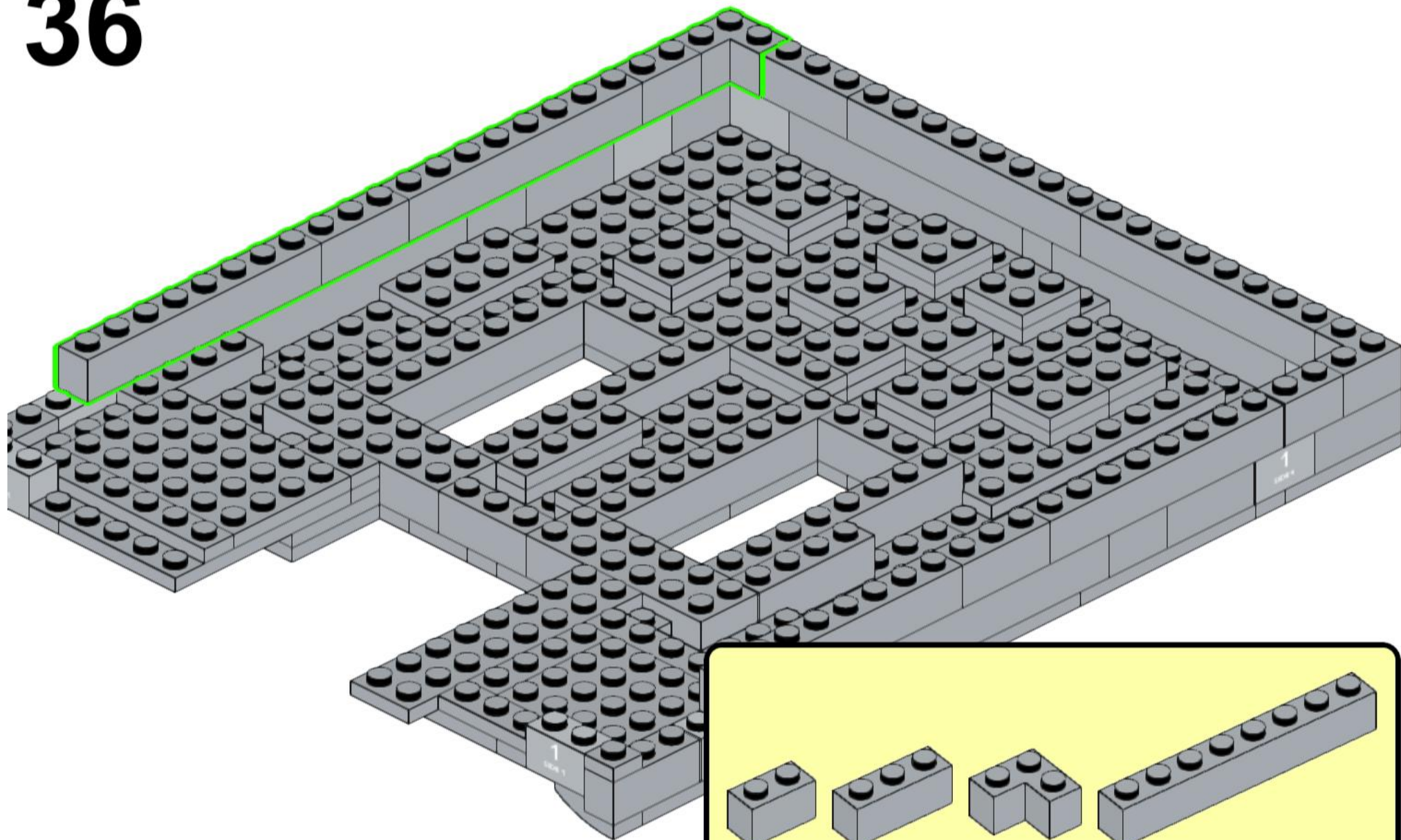

37

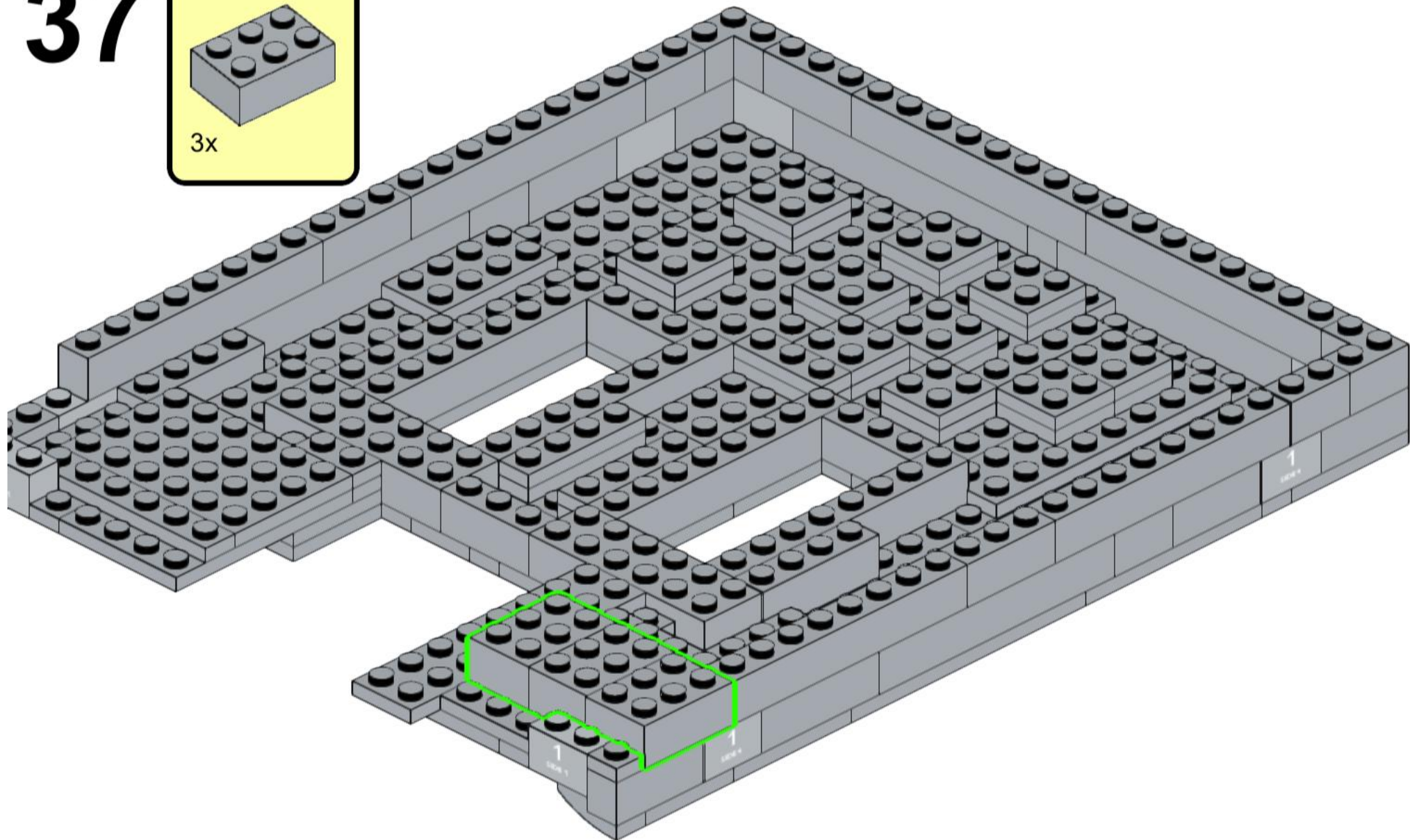
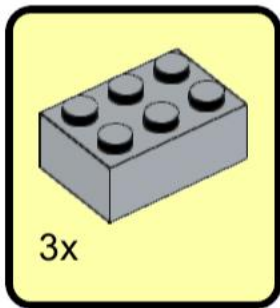

38

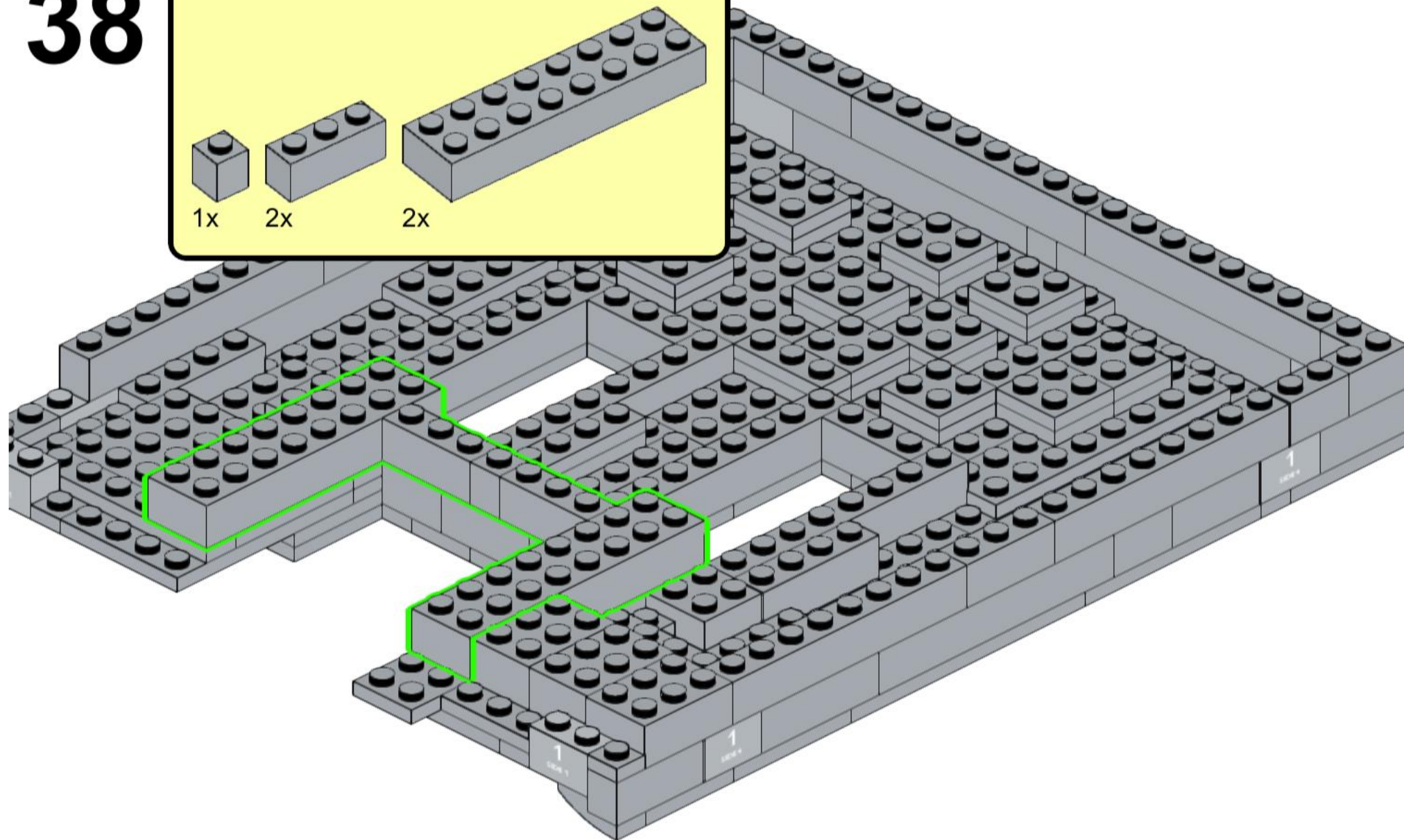
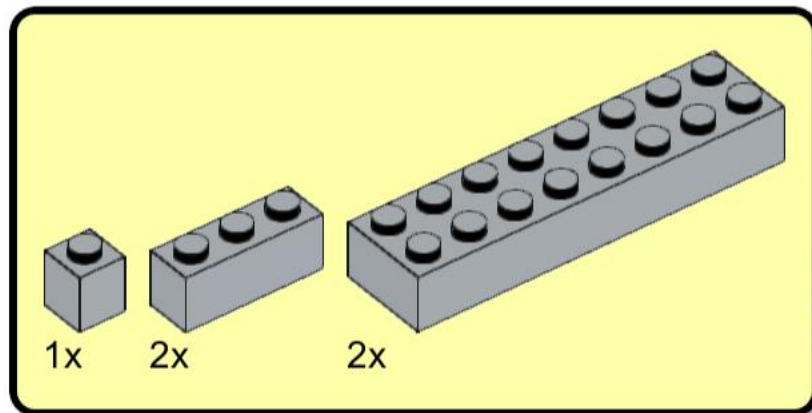

39

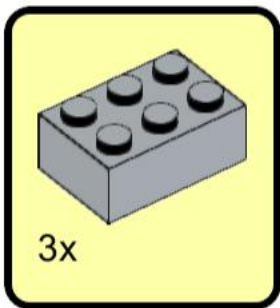
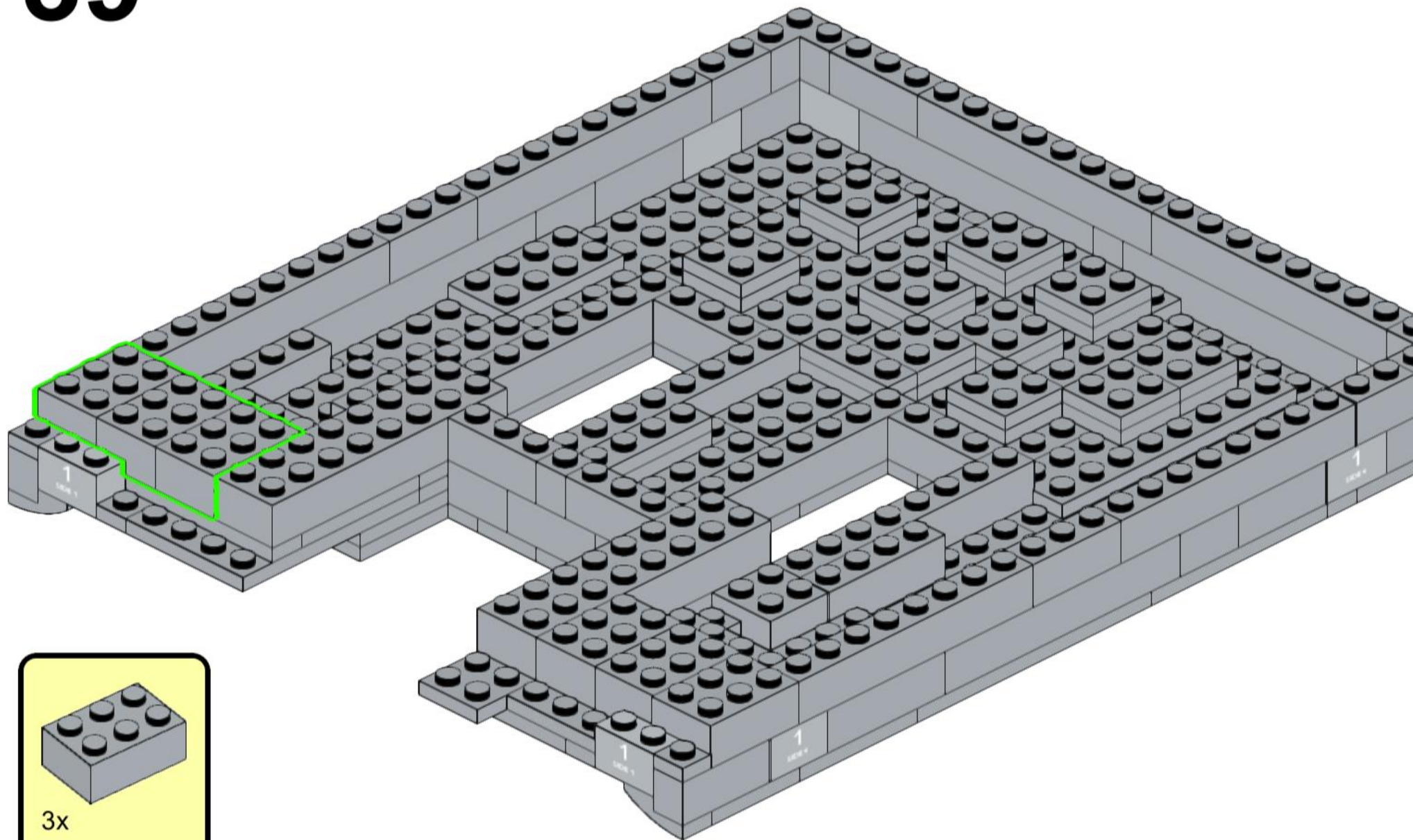

40

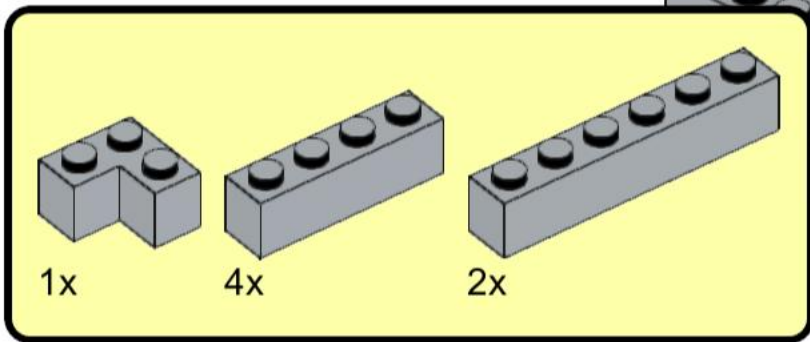
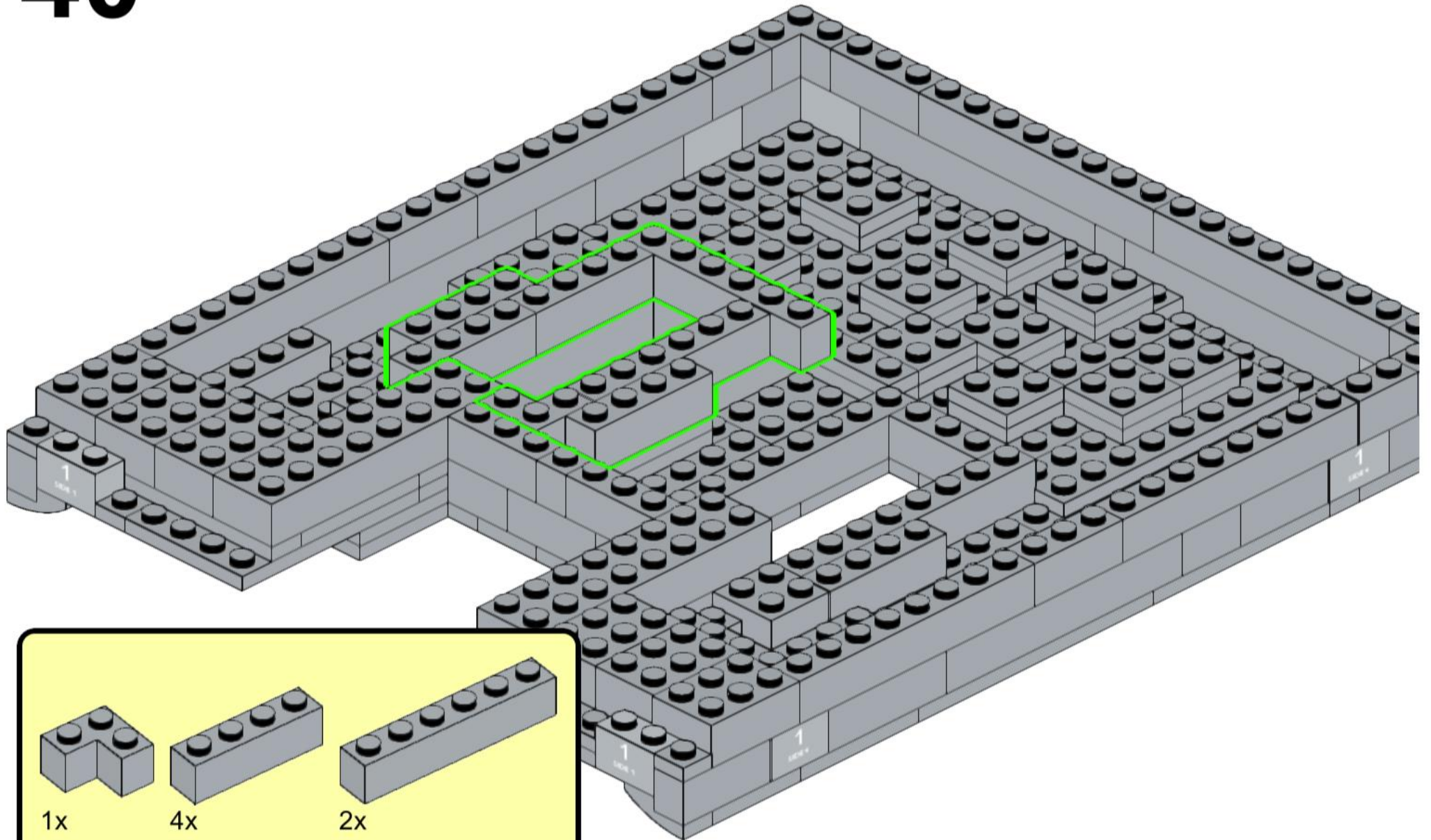

41

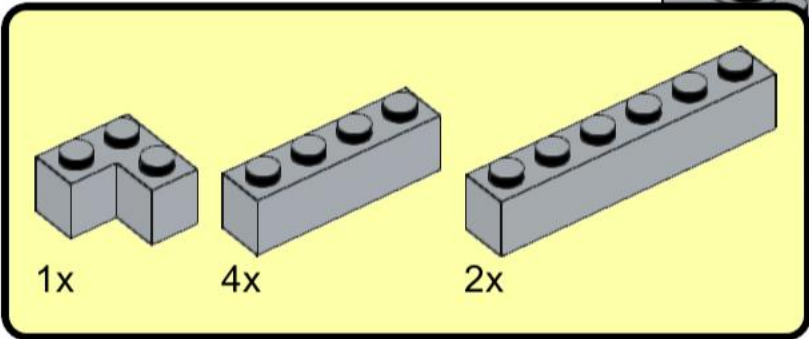
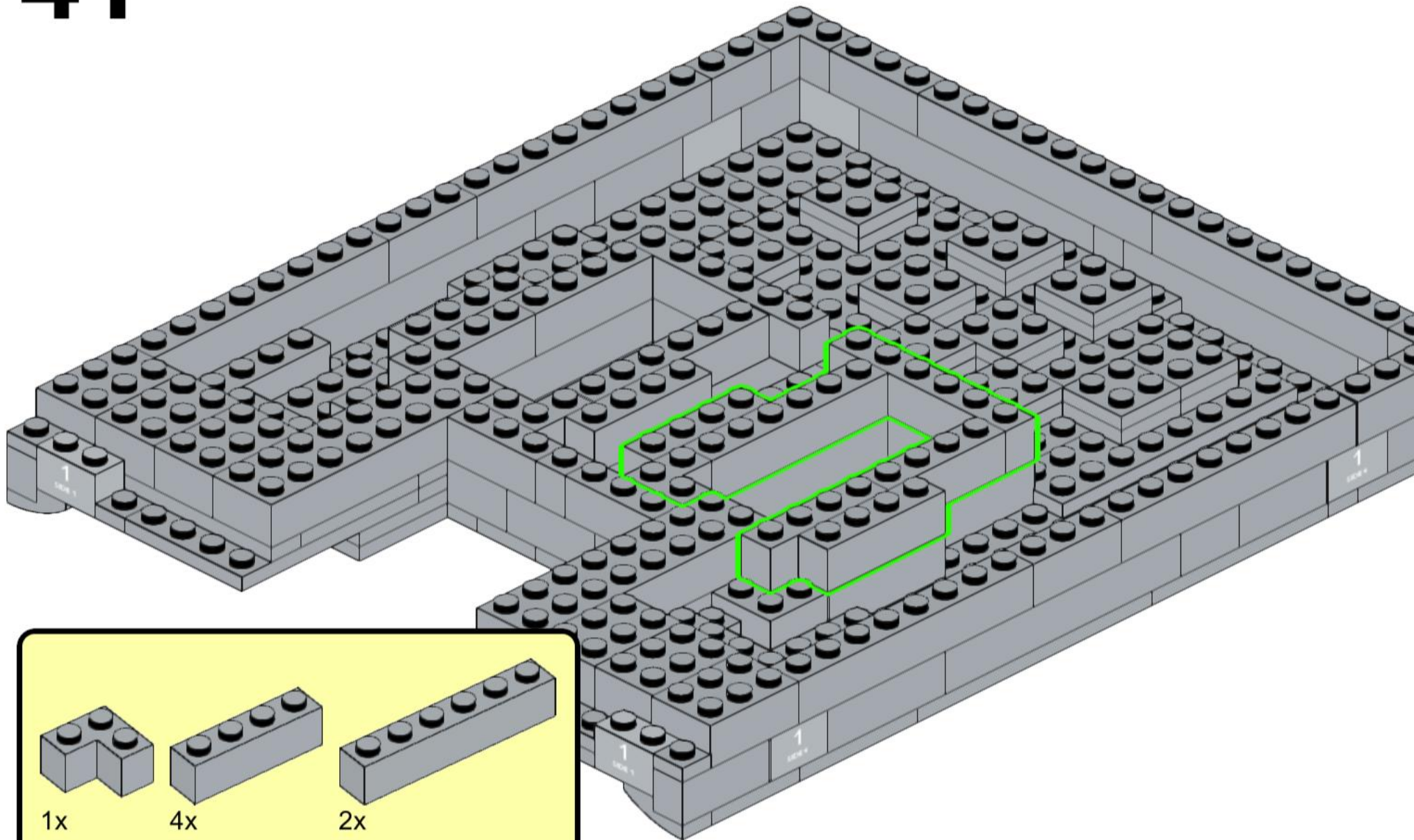

42

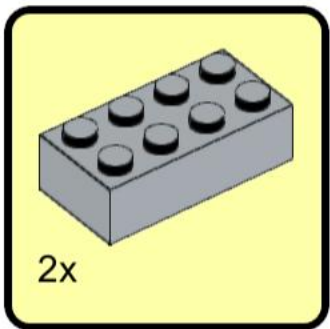
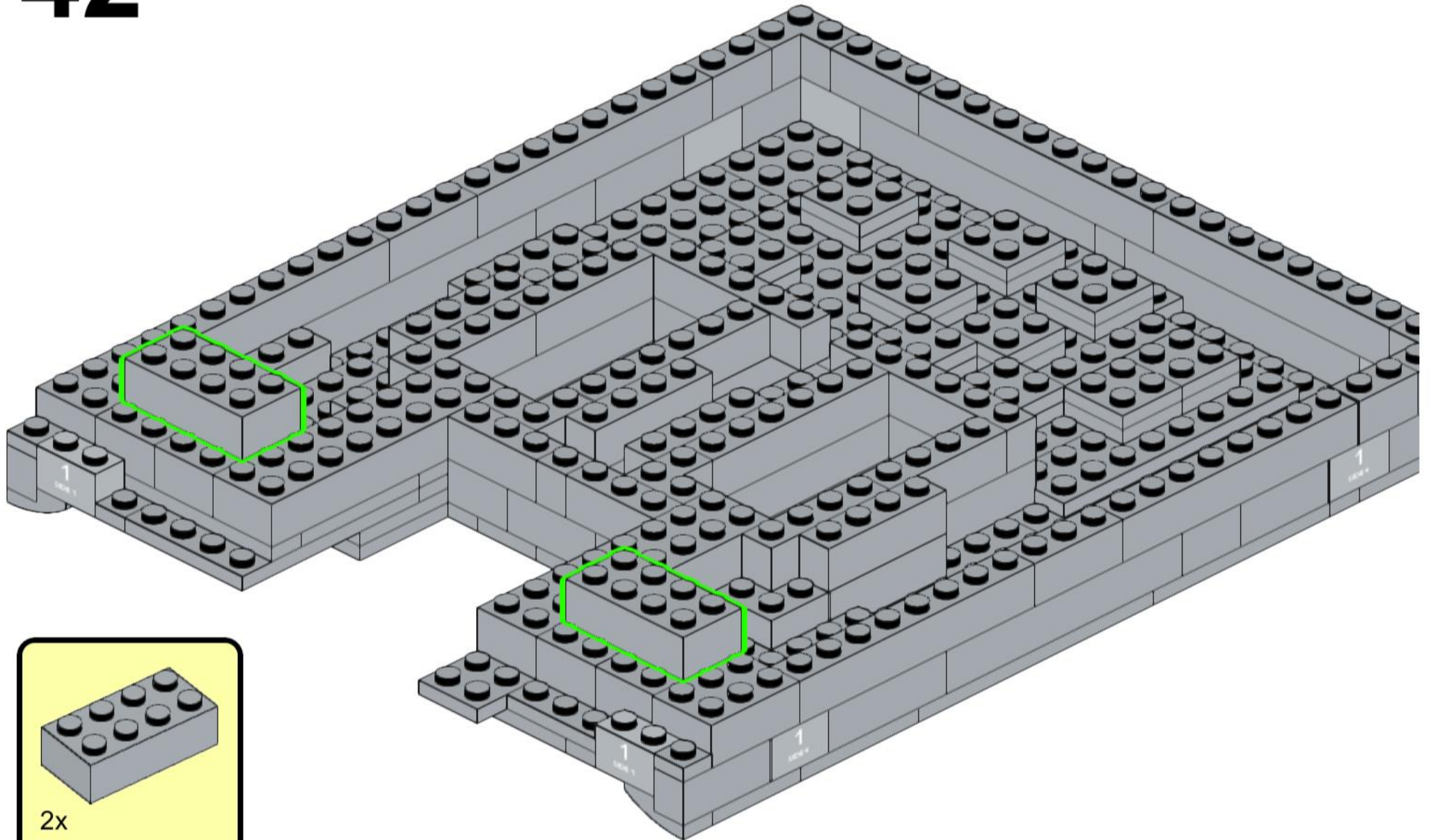

43

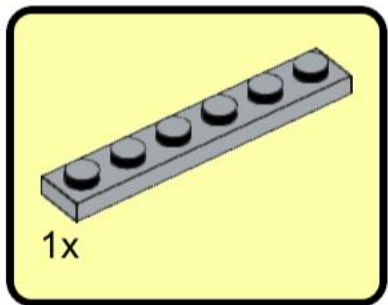
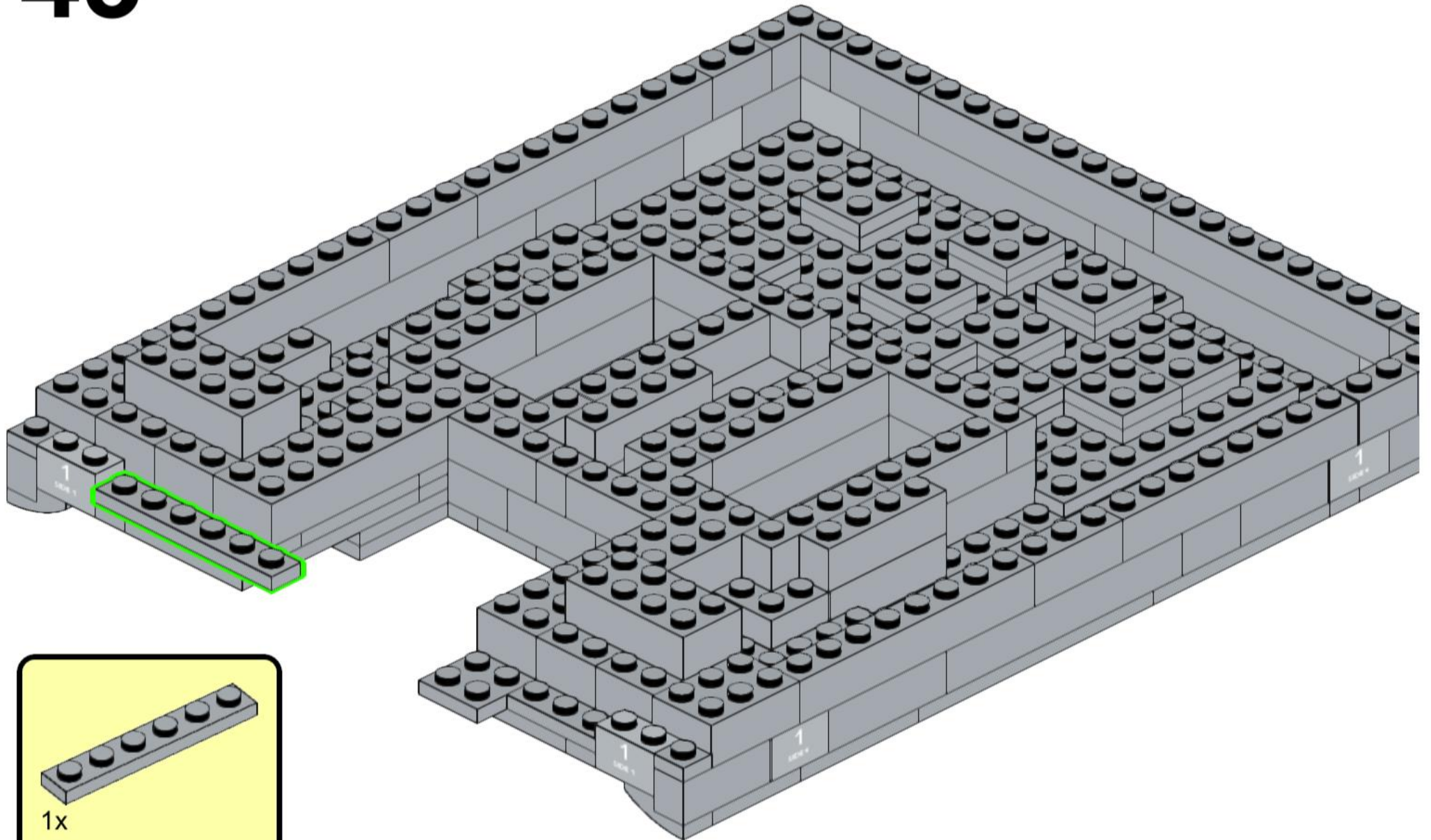

44

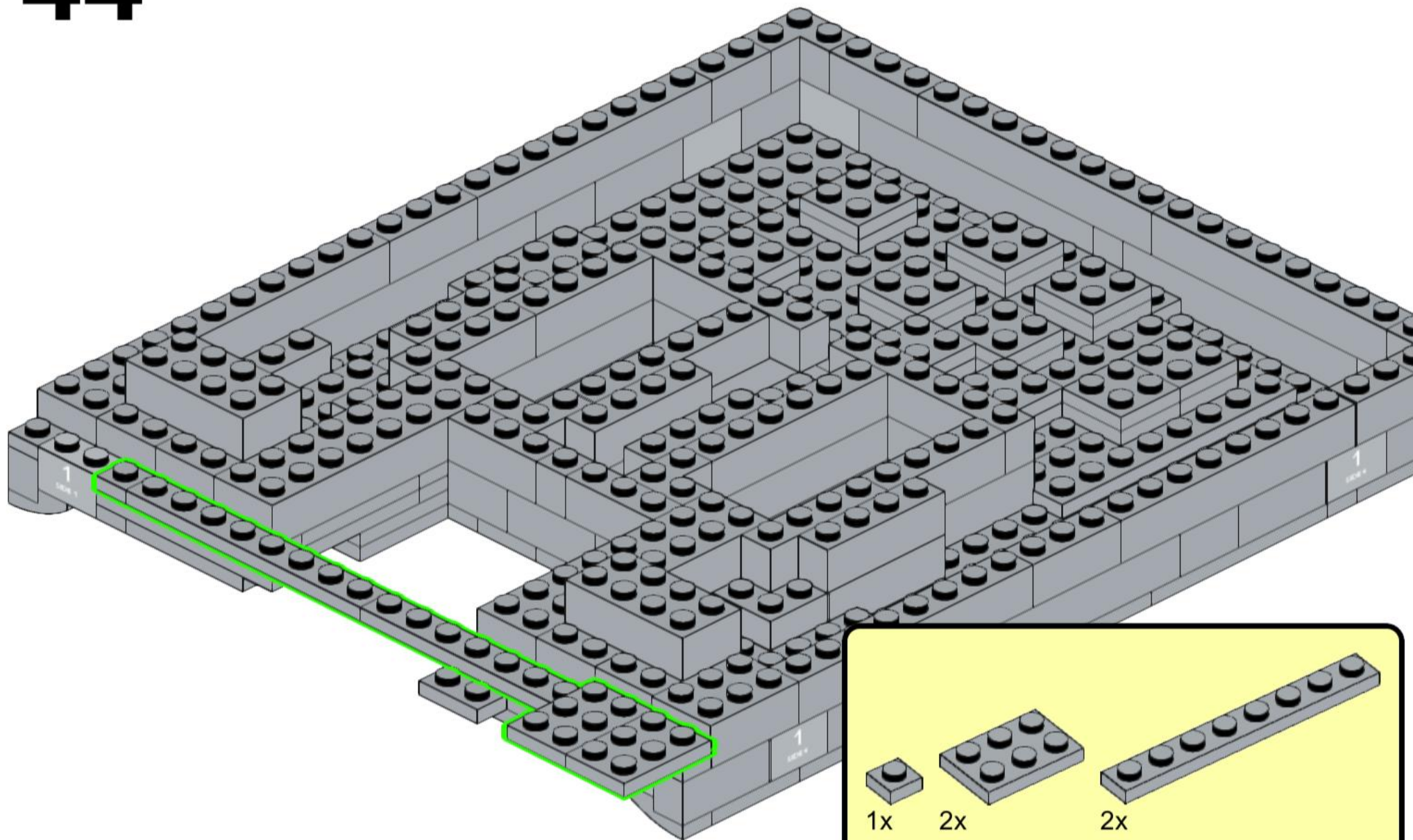

45

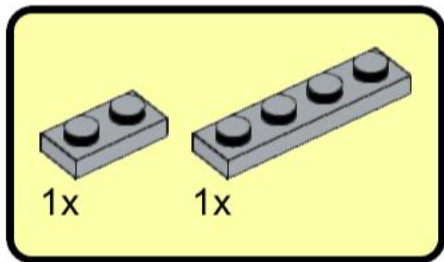
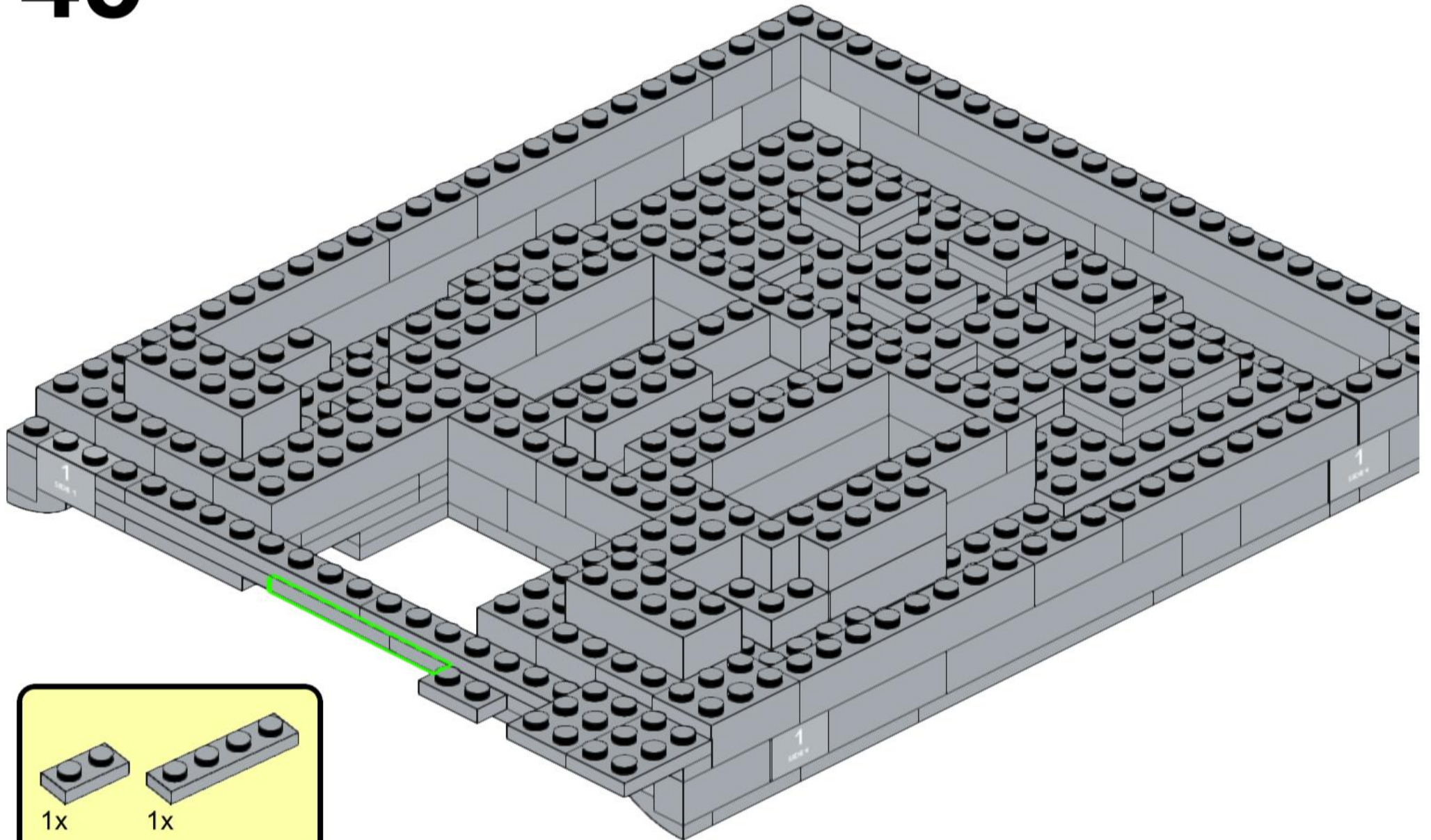

46

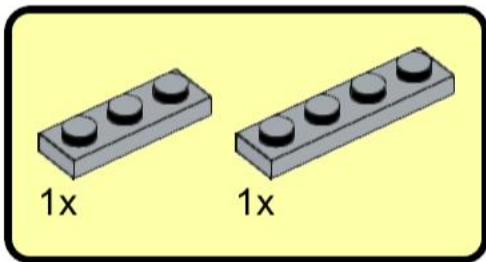
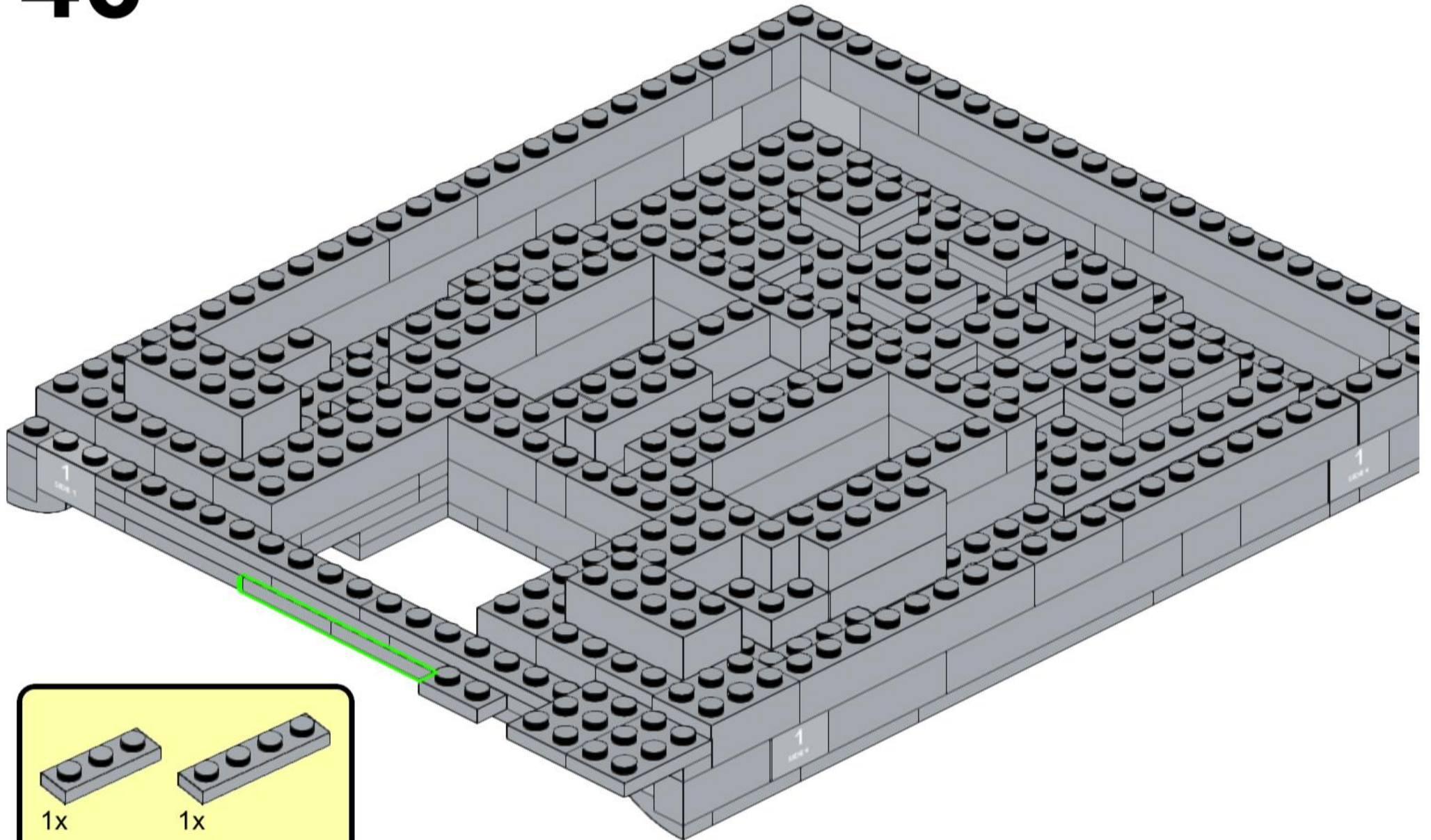

47

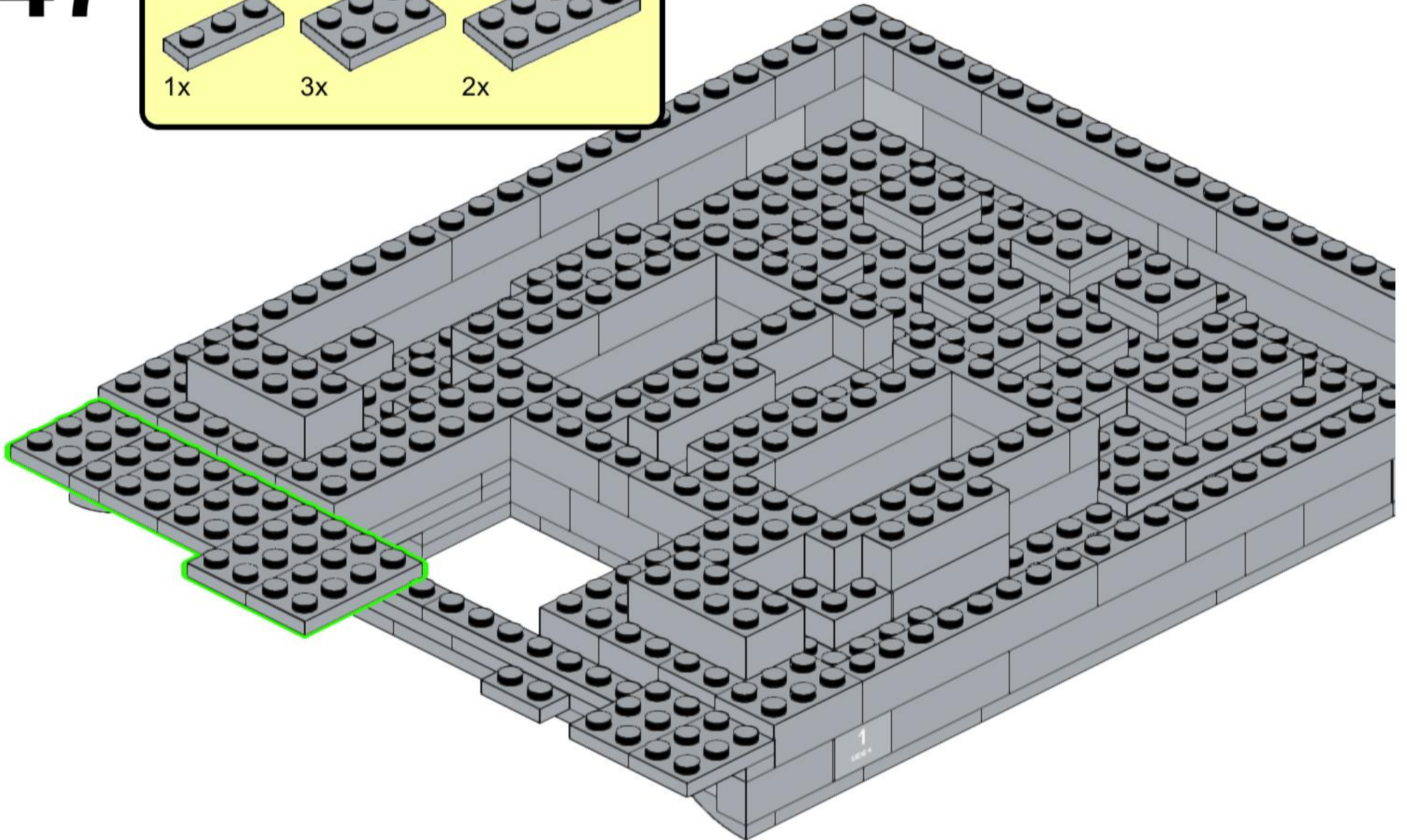
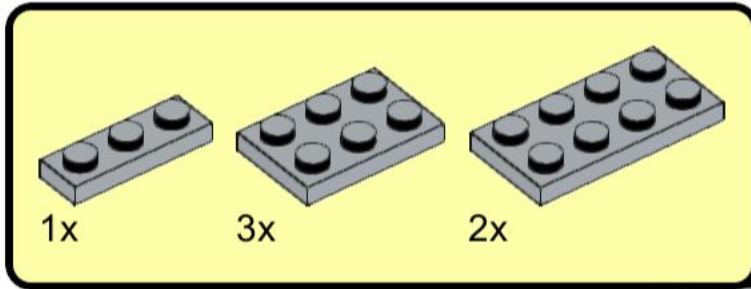

48

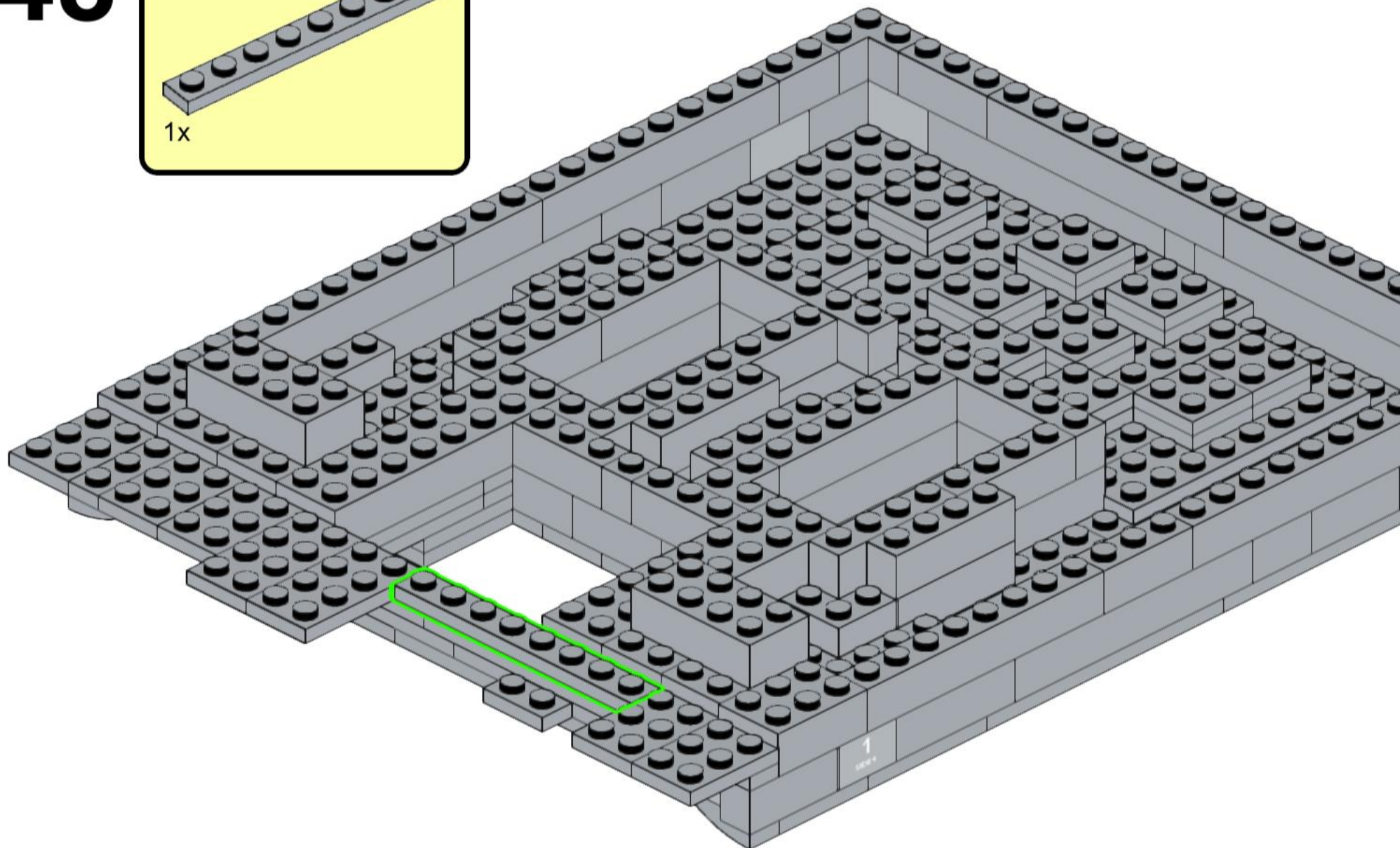
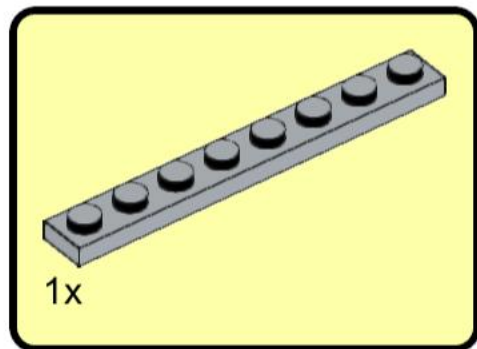

49

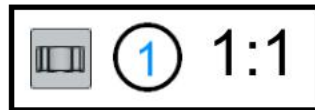
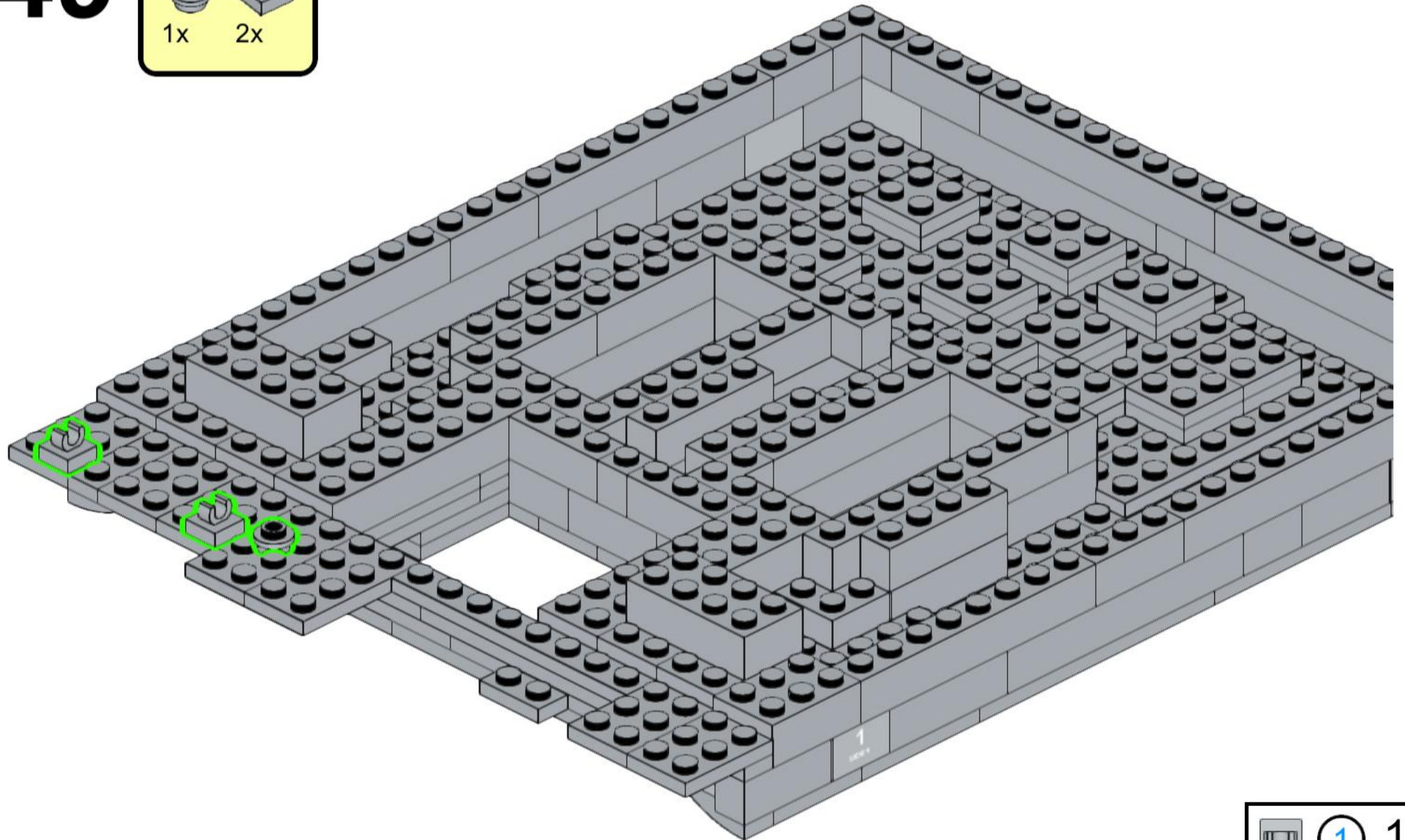
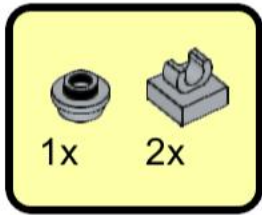

50

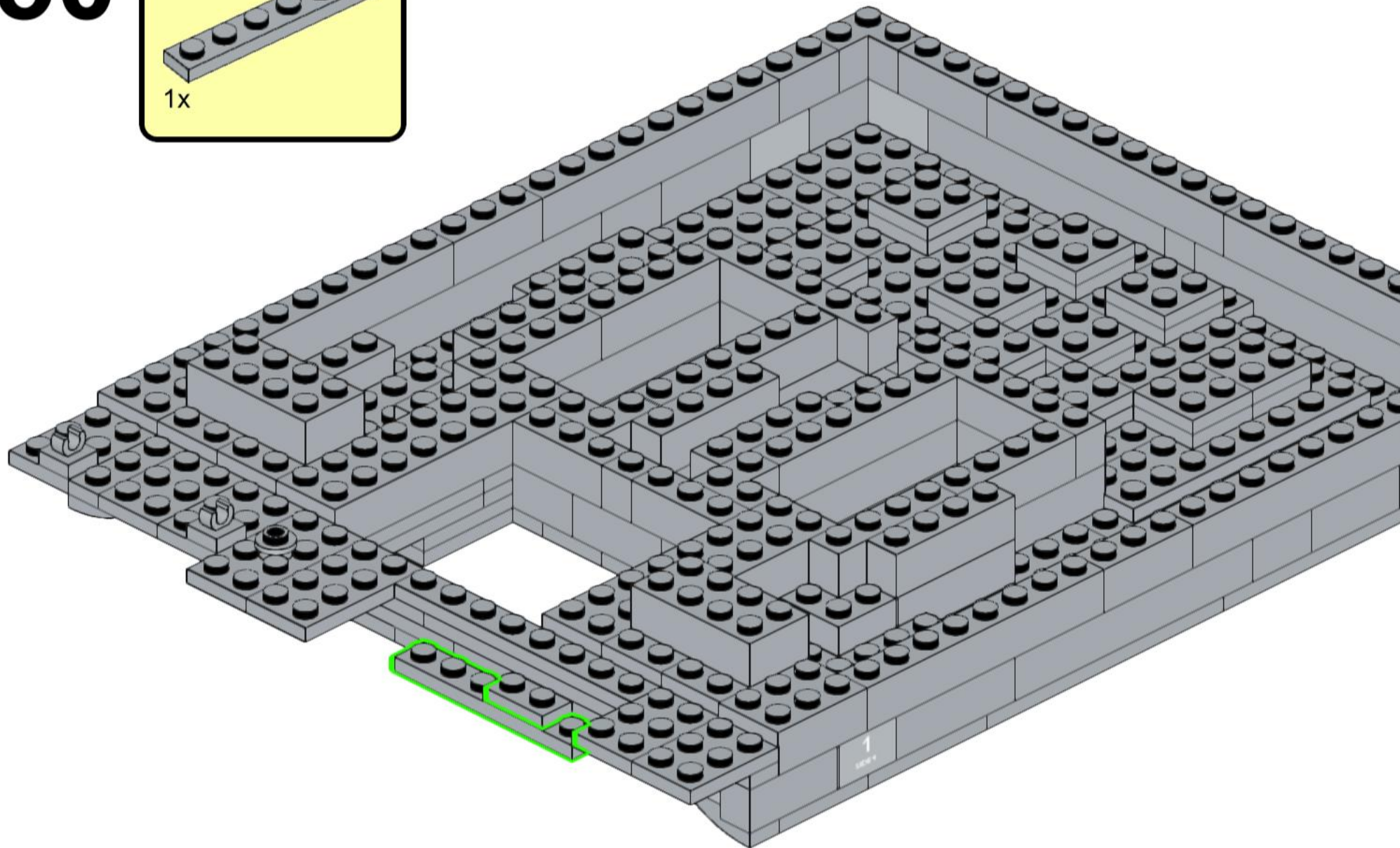
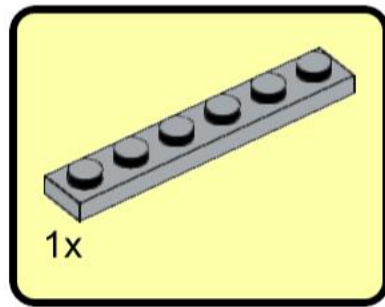

51

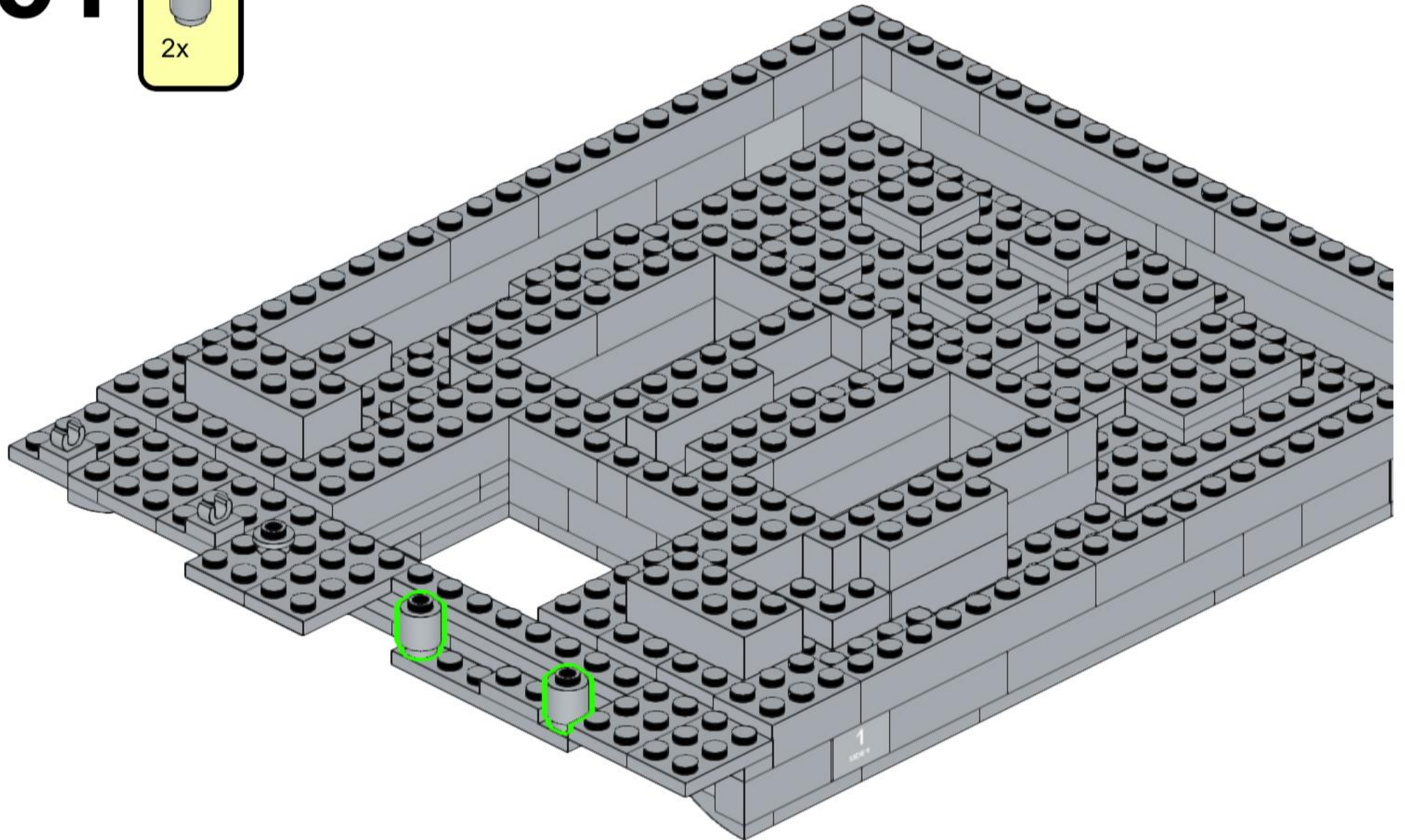
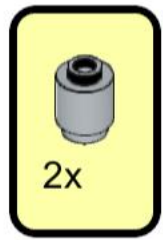

52

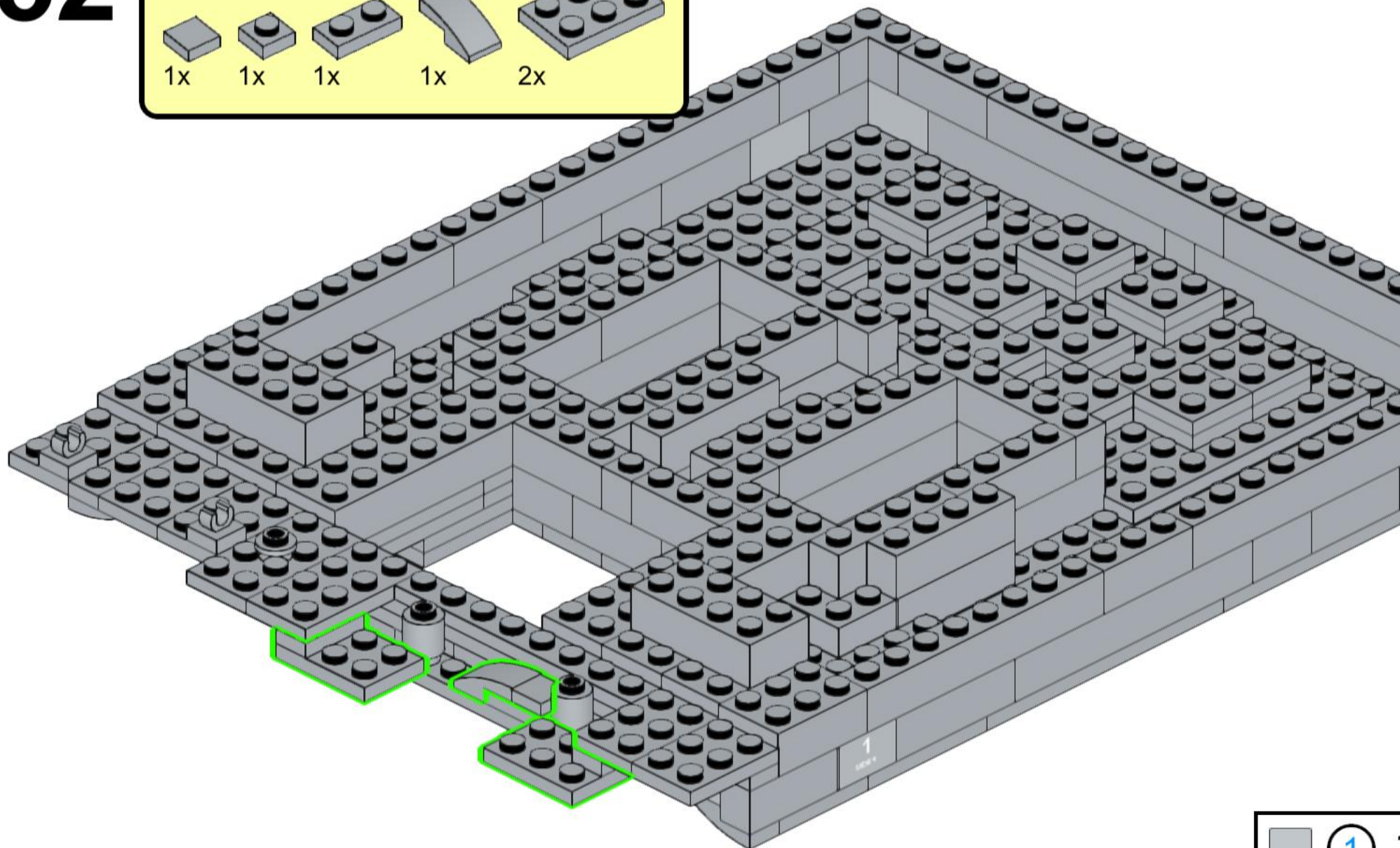
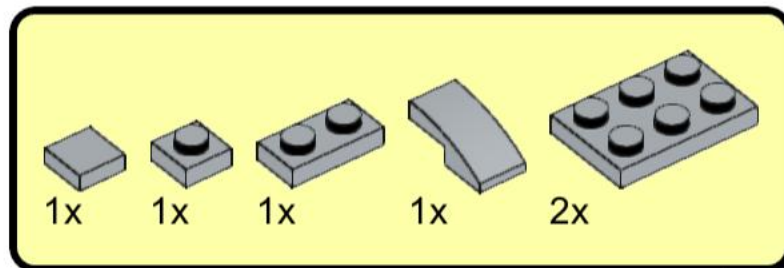

53

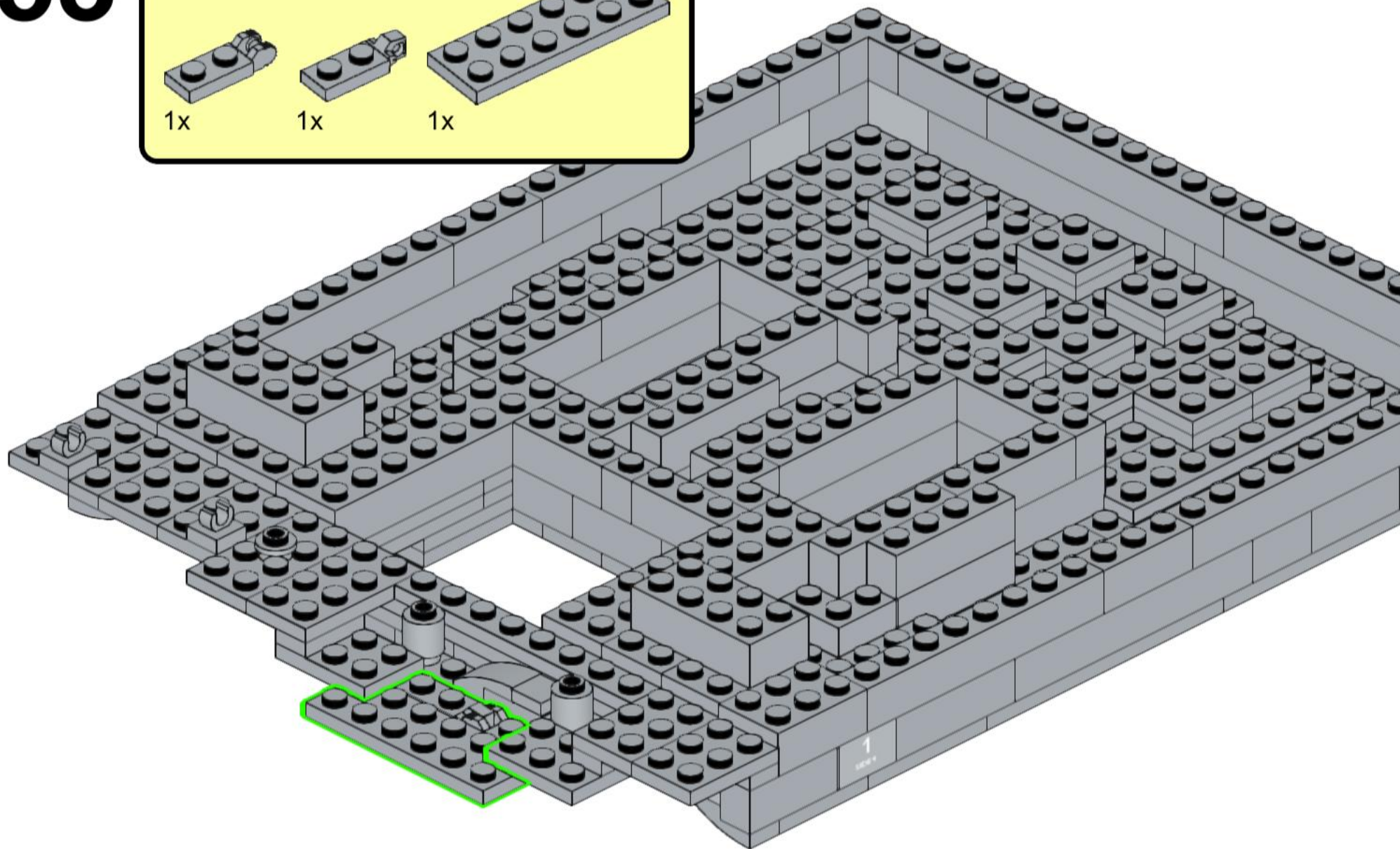
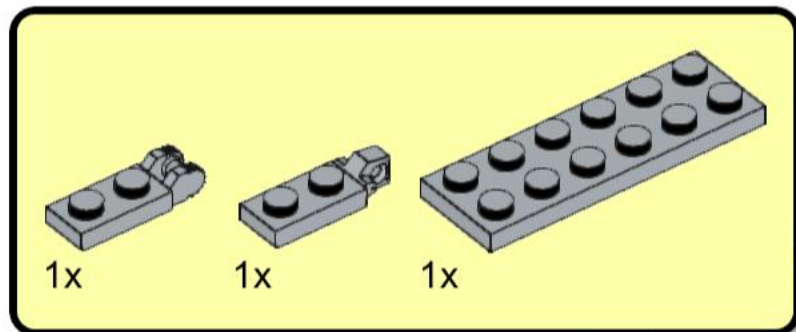

54

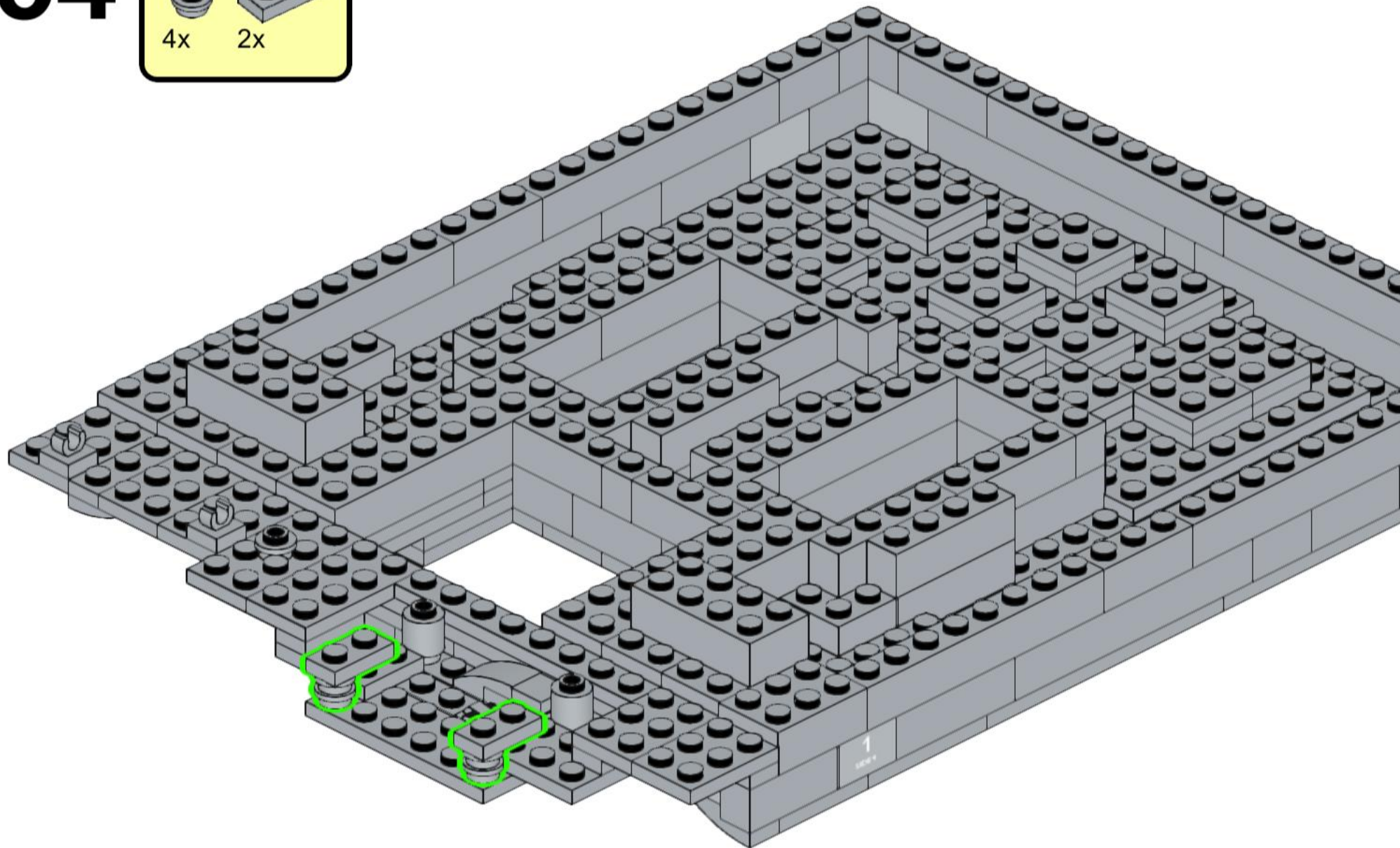
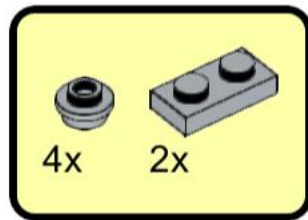

55

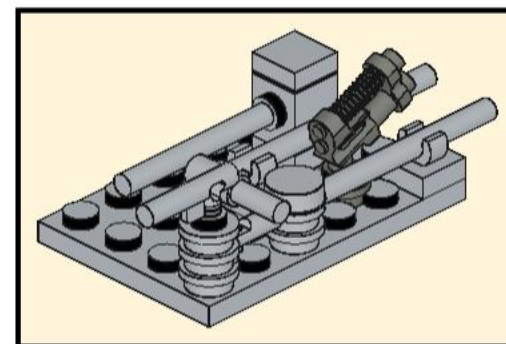
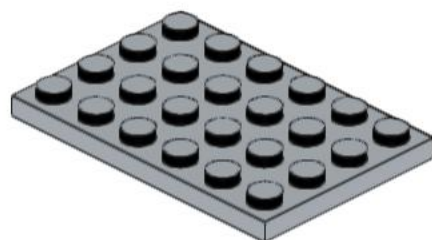
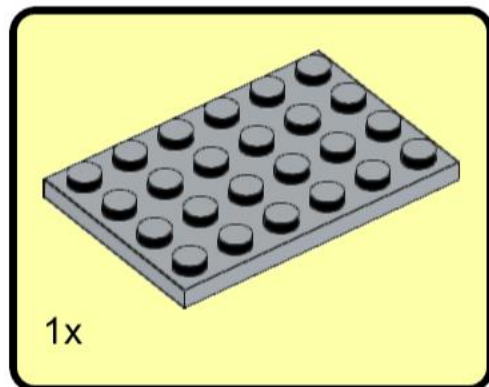

56

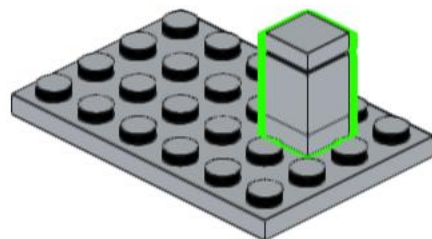
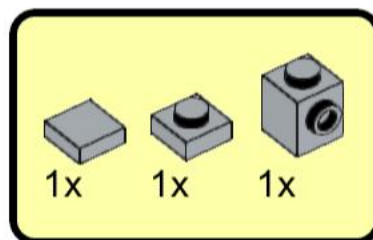

57

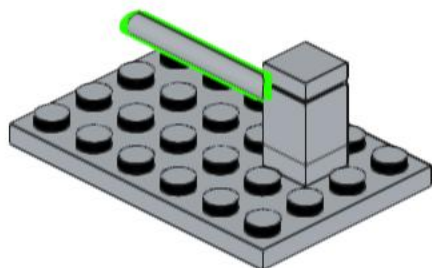
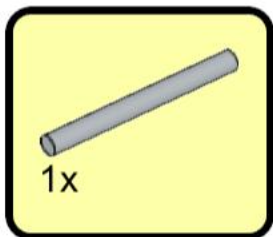

58

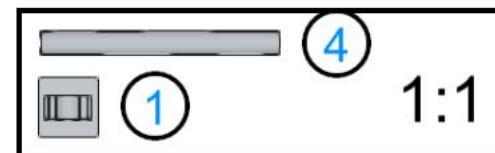
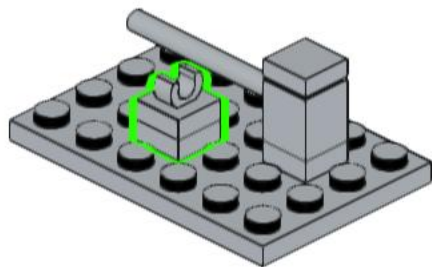
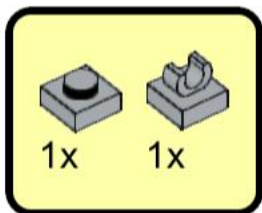

59

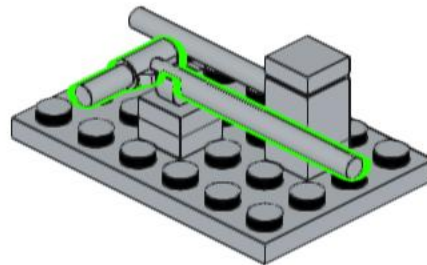
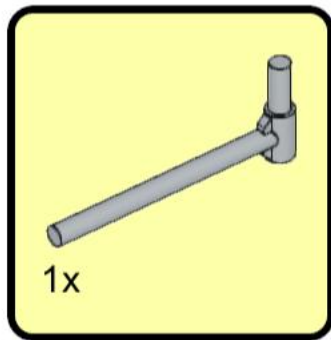

60

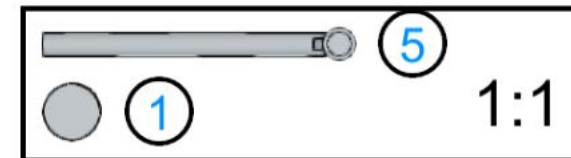
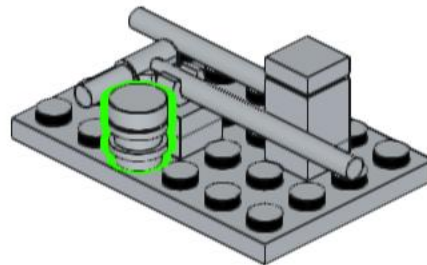
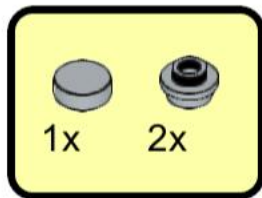

61

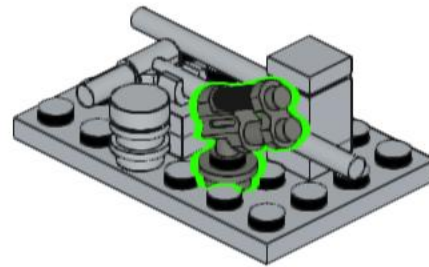
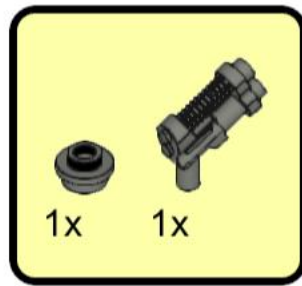

62

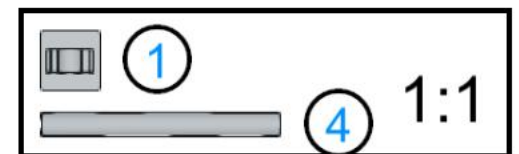
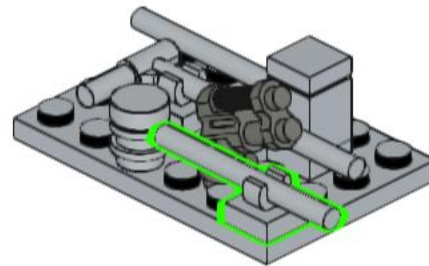
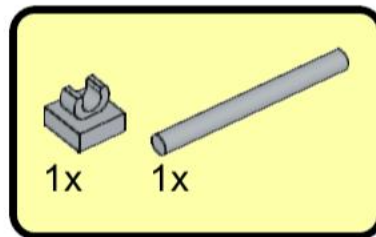

63

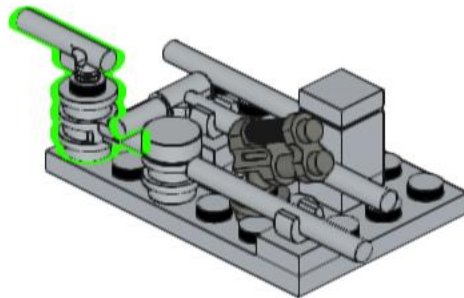
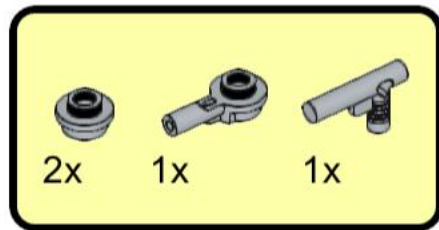

64

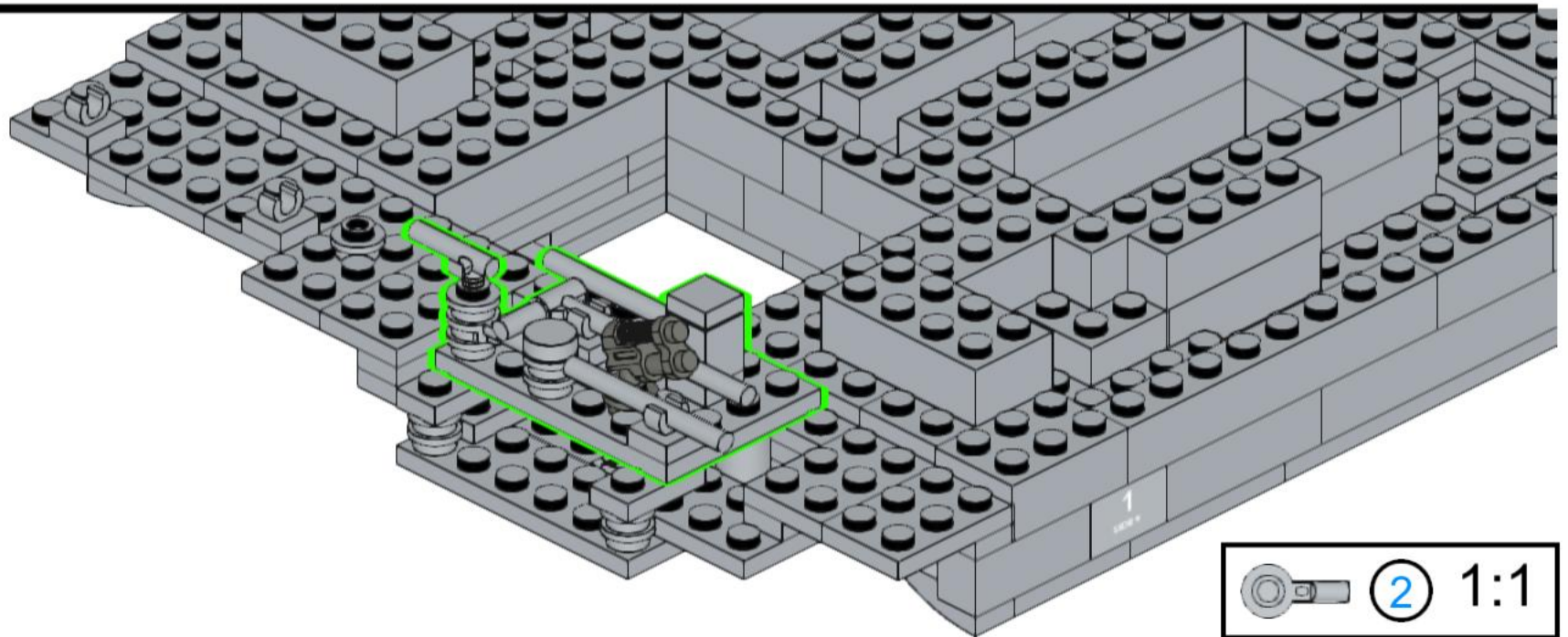

65

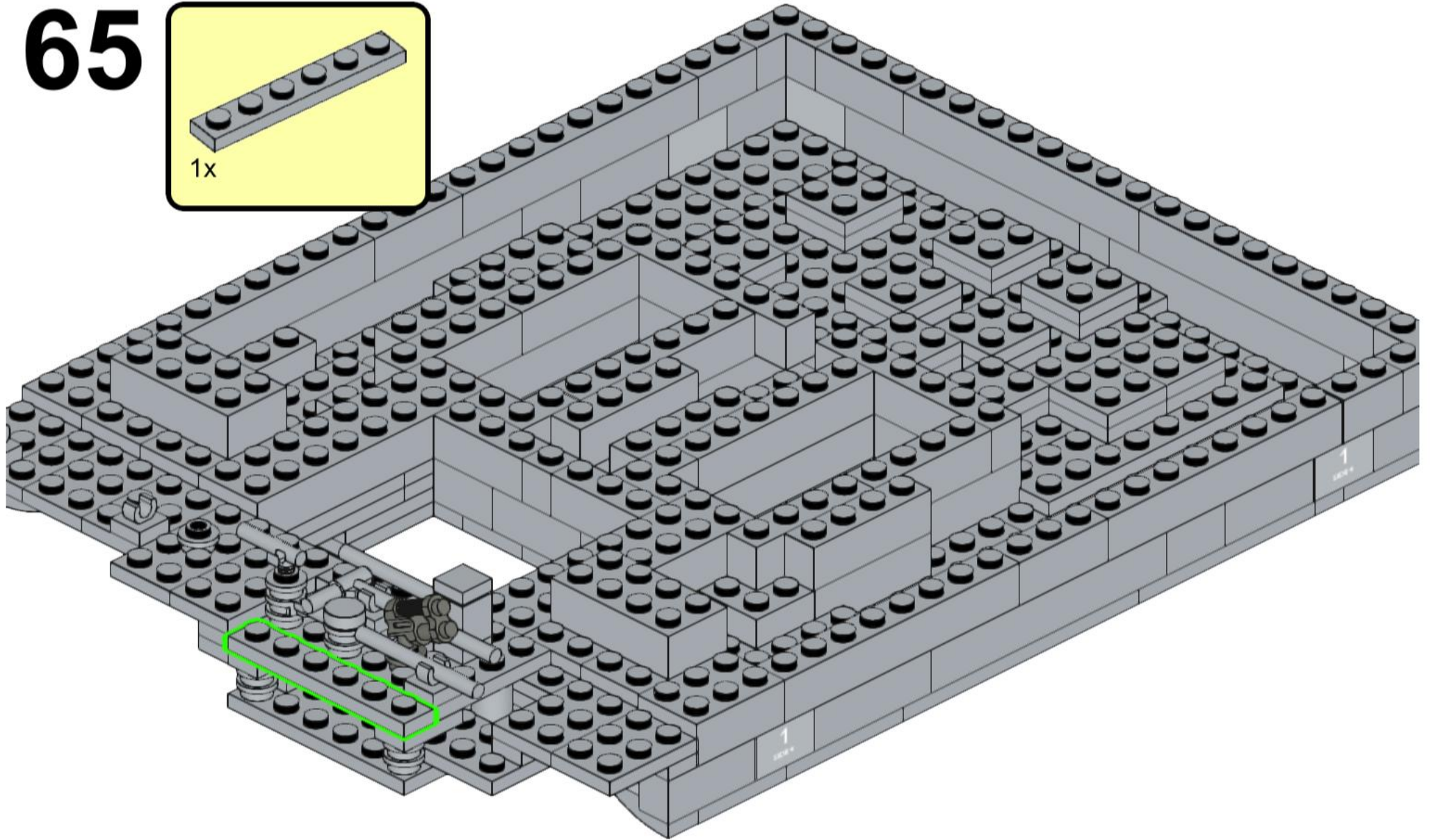
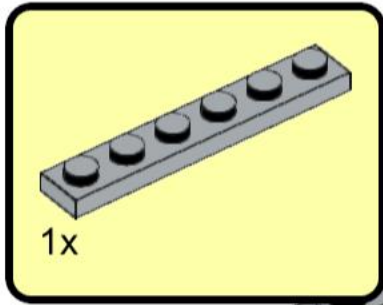

67

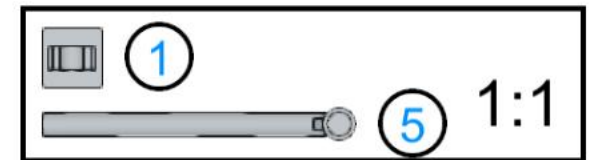
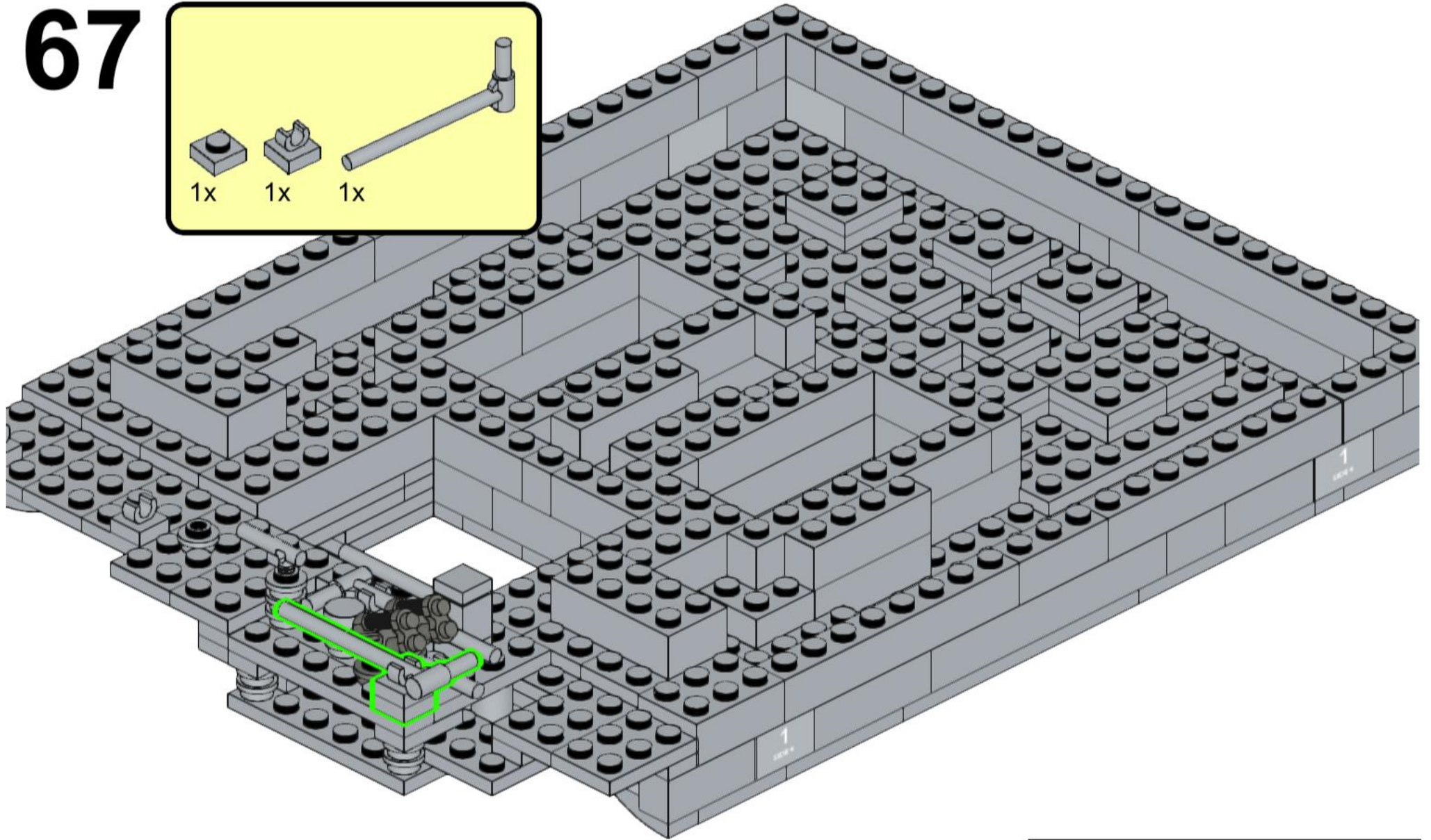
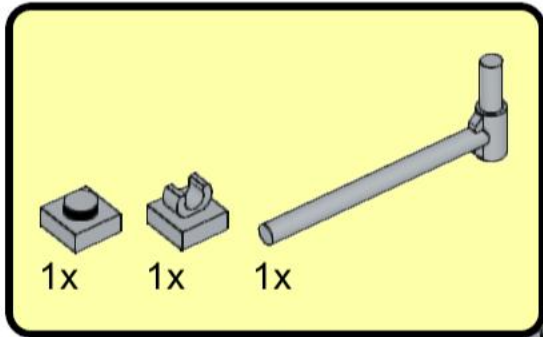

68

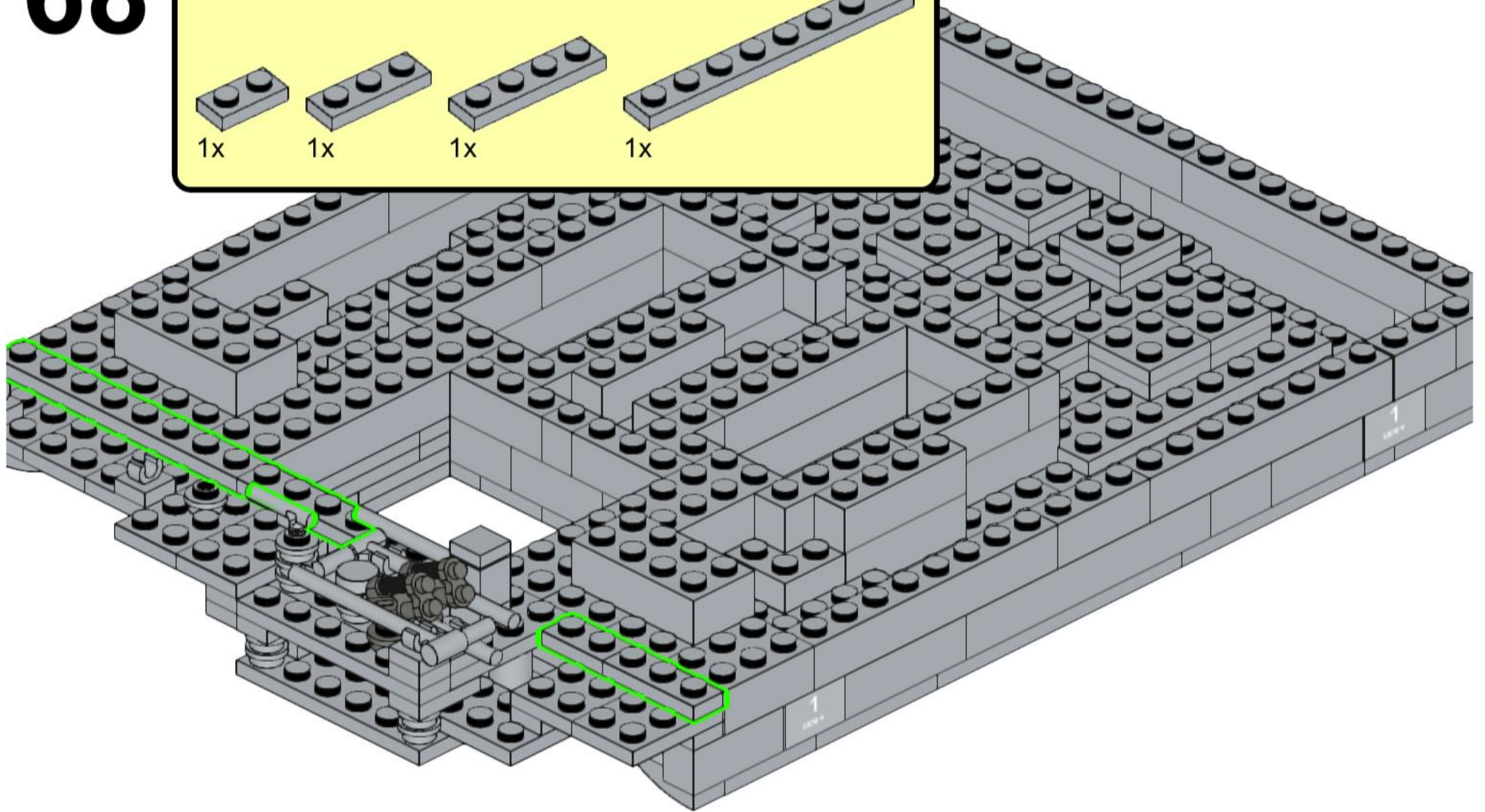
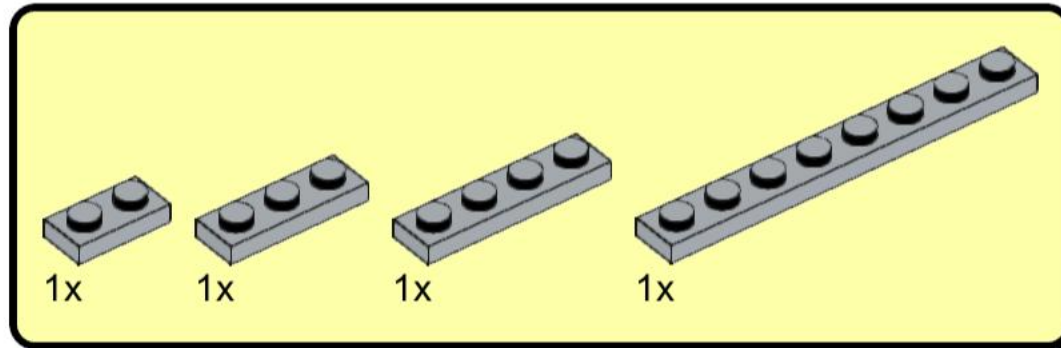

69

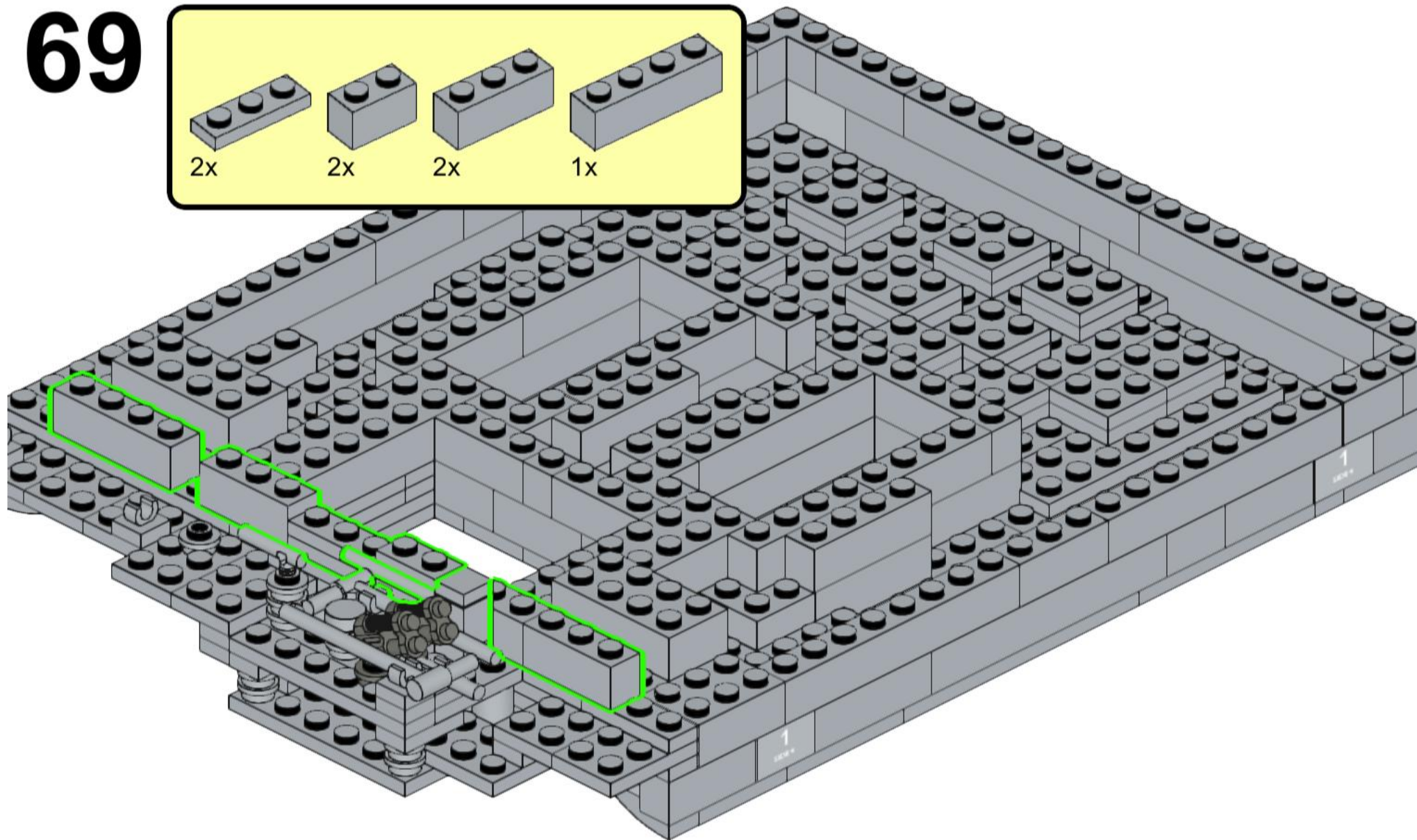
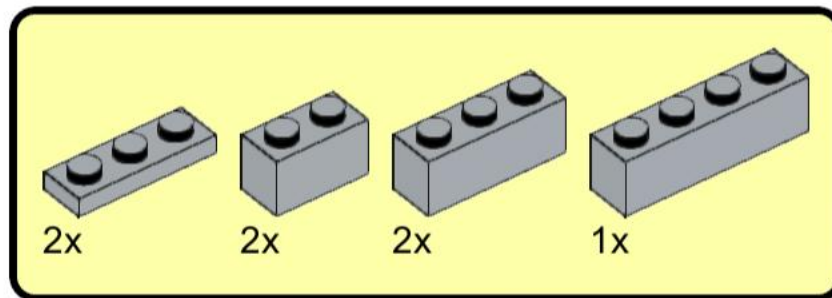

70

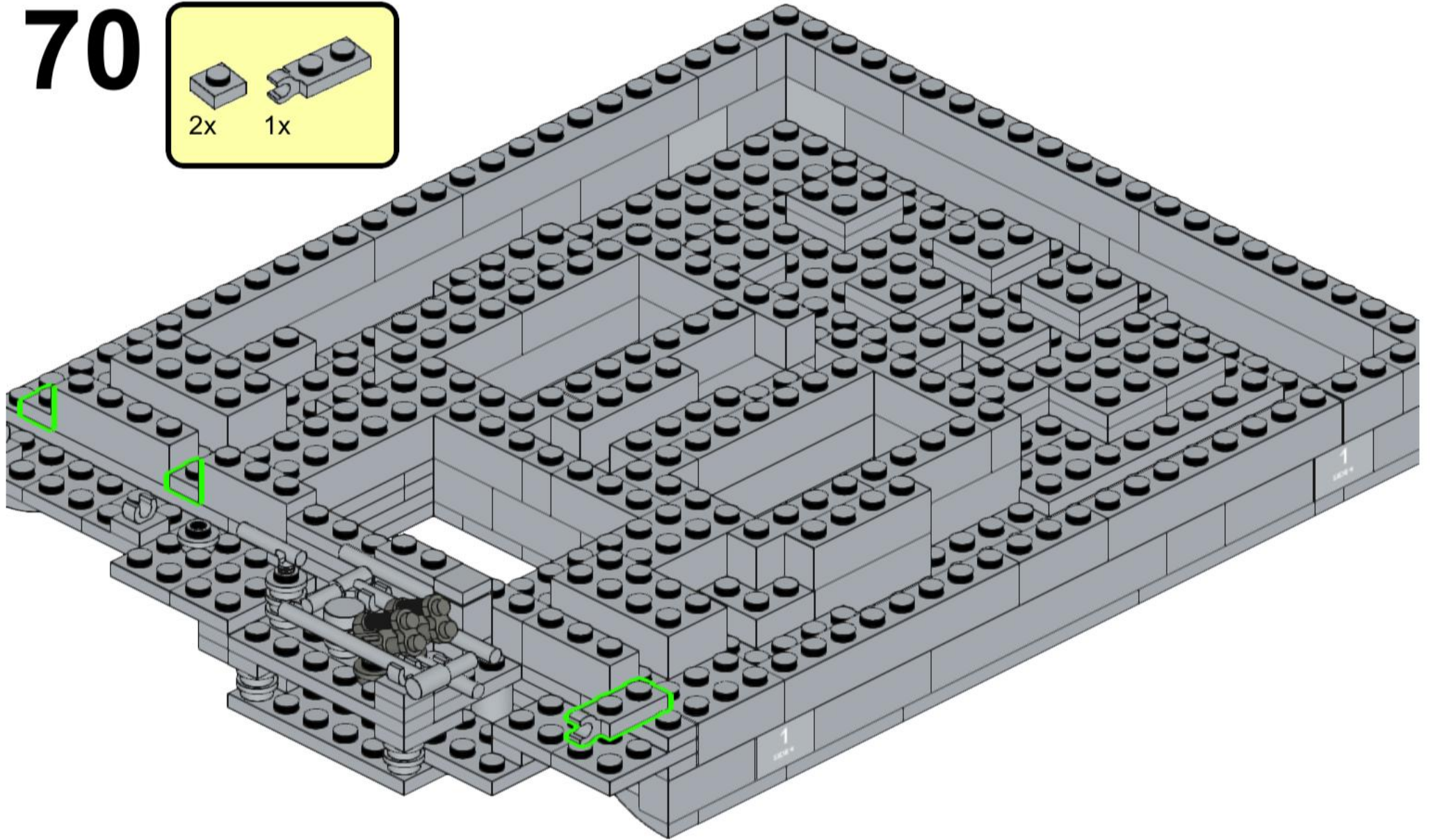
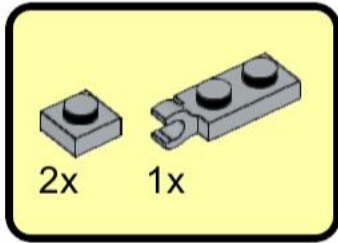

71

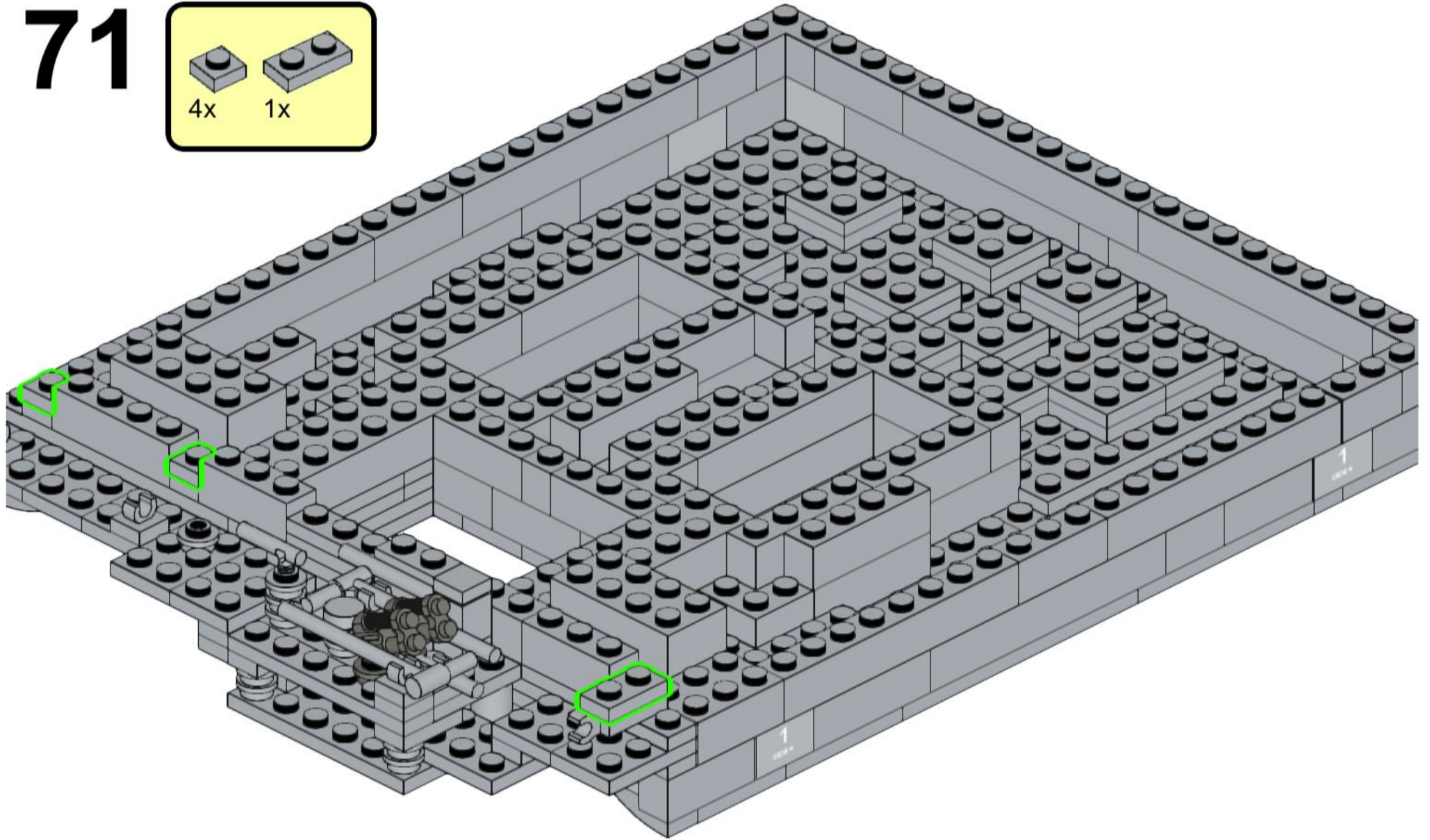
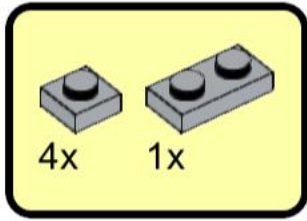

72

1x 1x 1x 5x 1x 1x

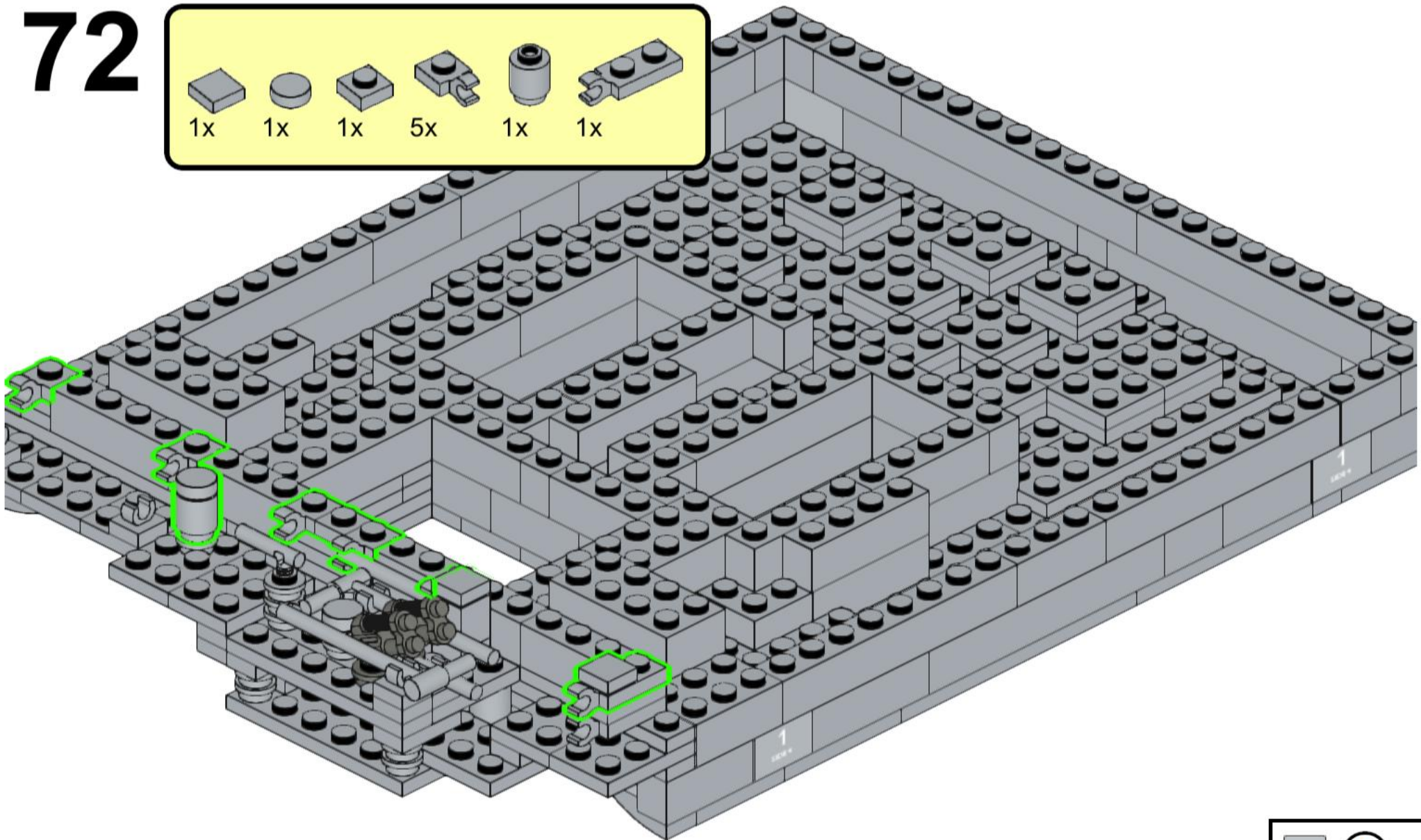
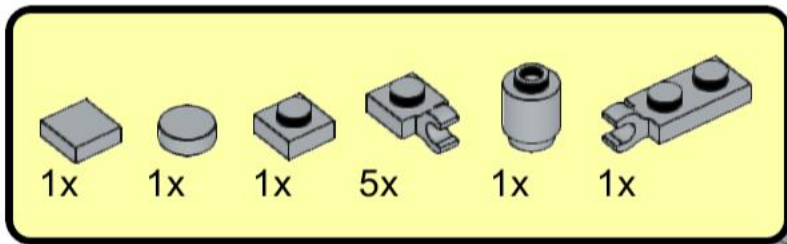

1 1 1:1

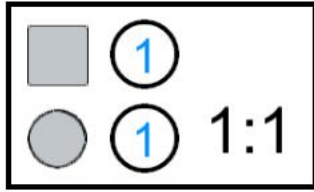

73

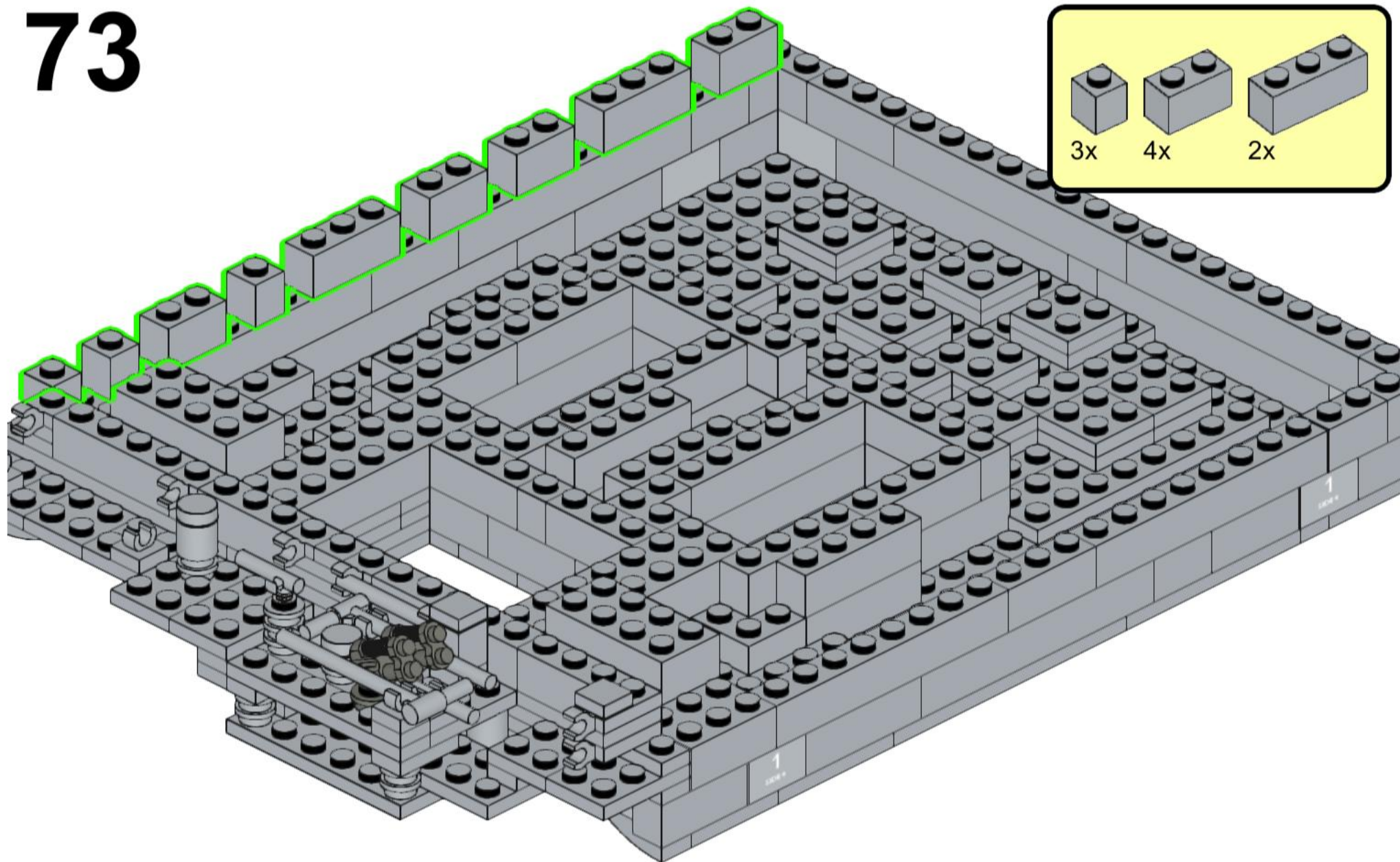

74

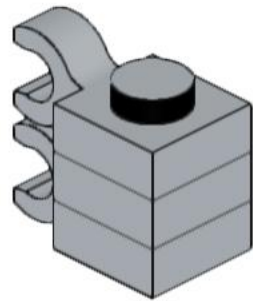
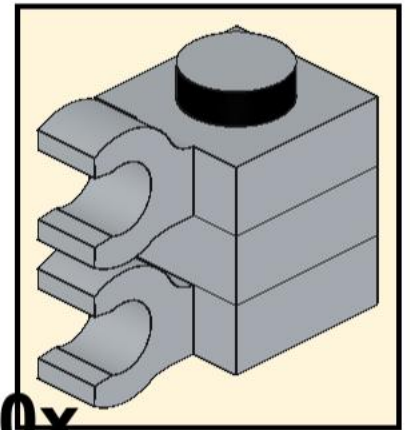
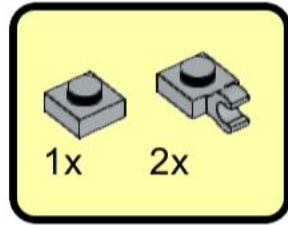

75

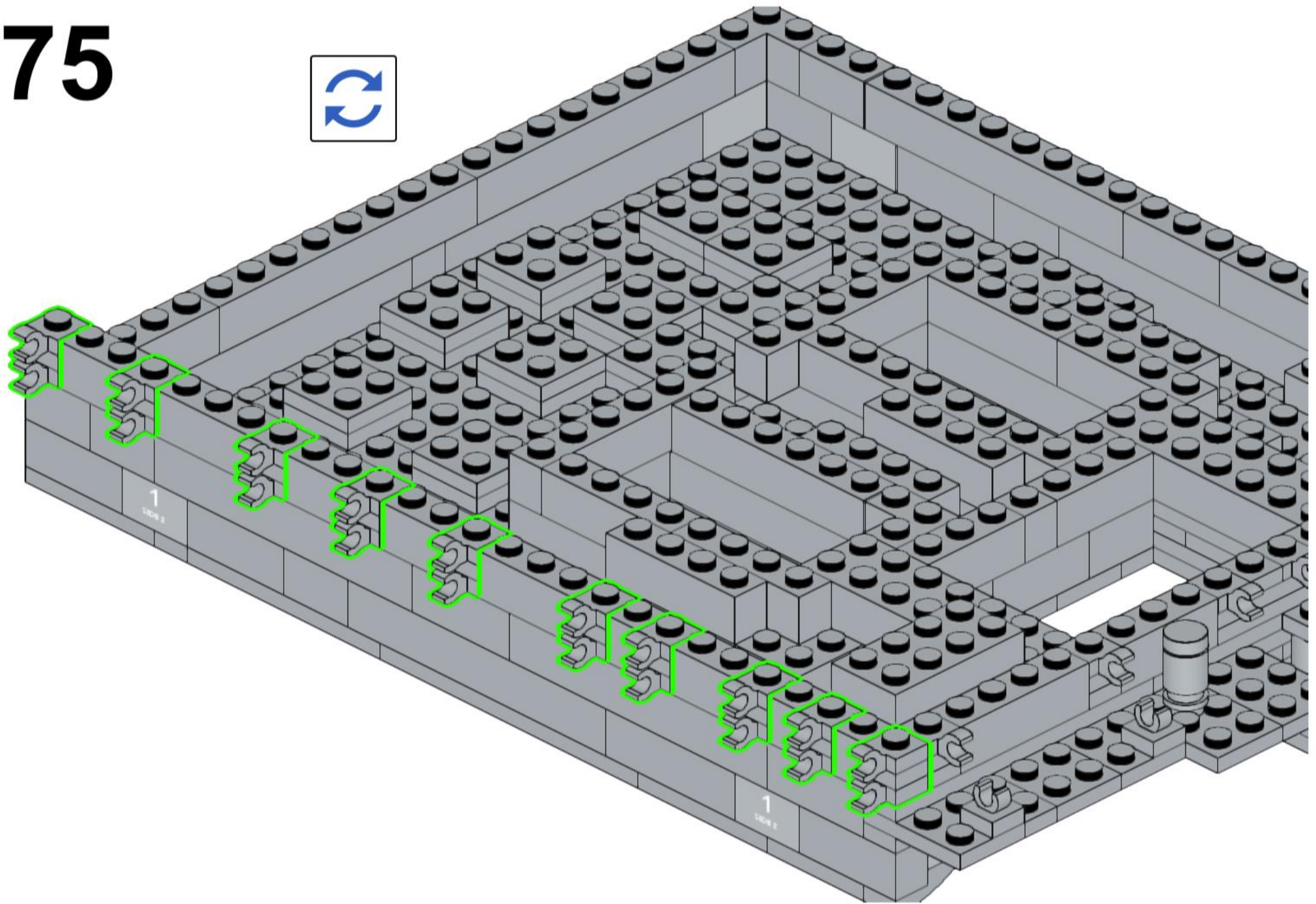

76

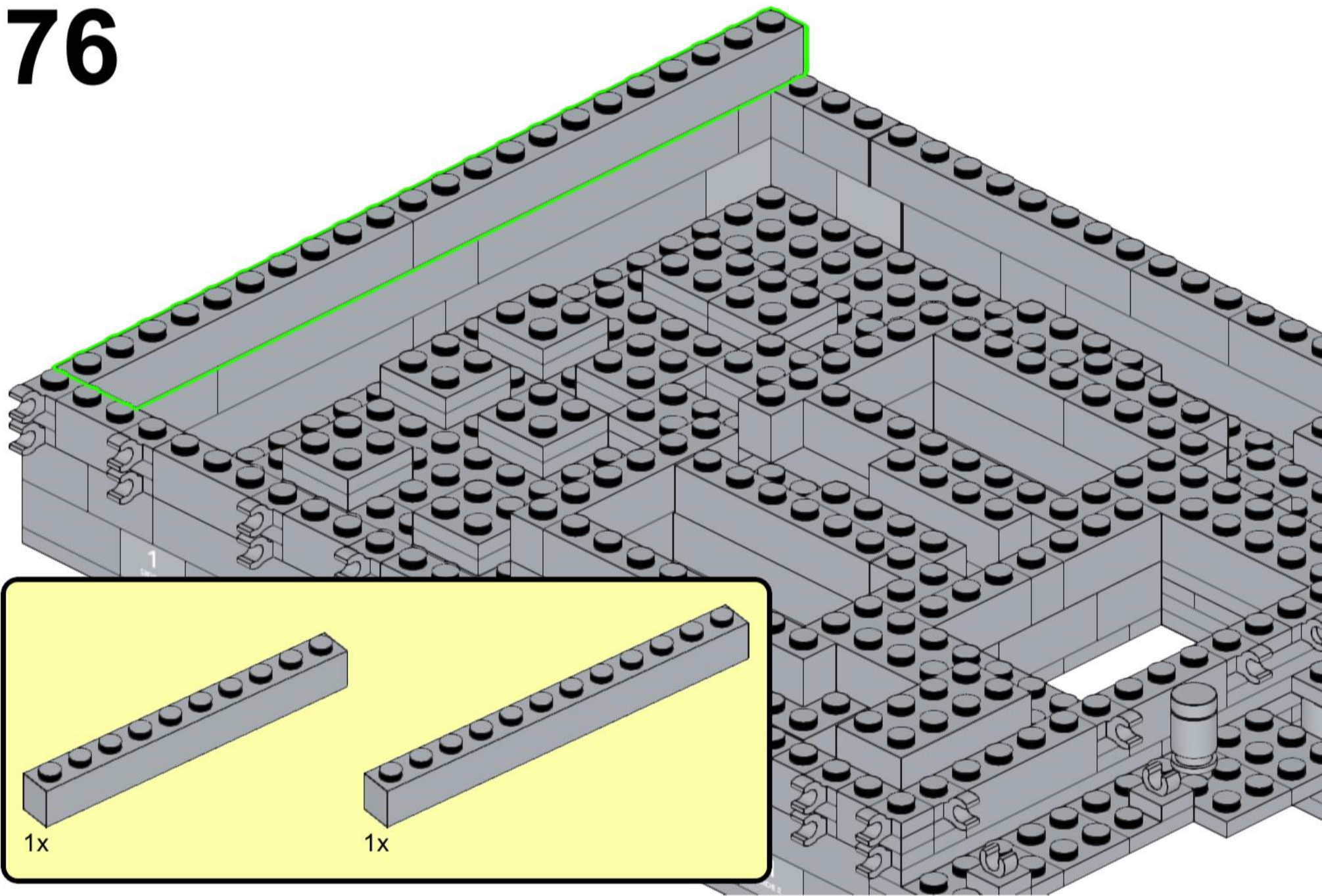

77

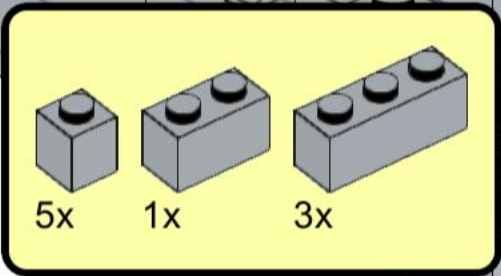
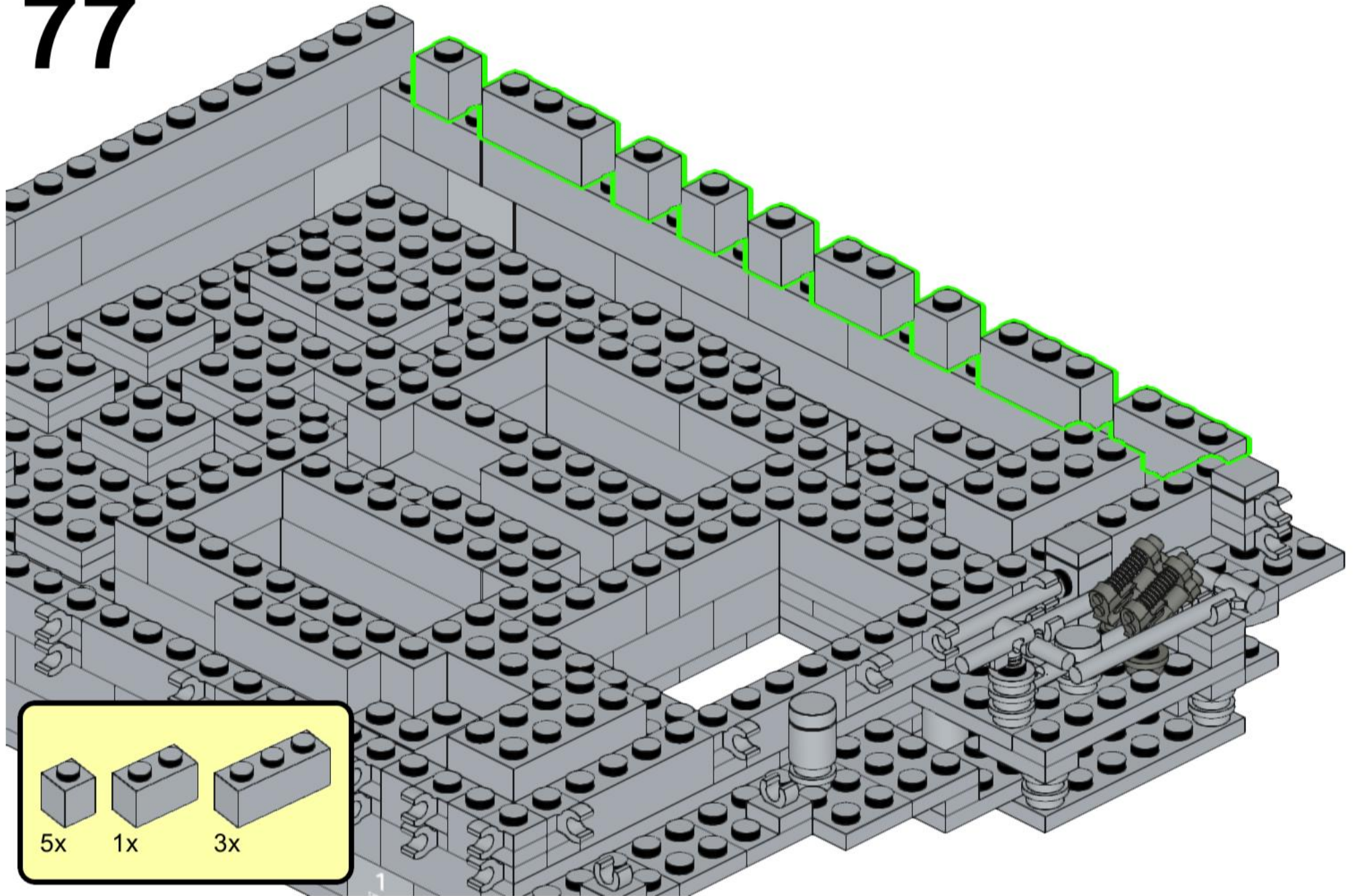

78

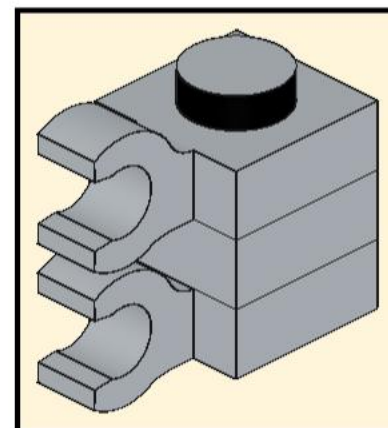
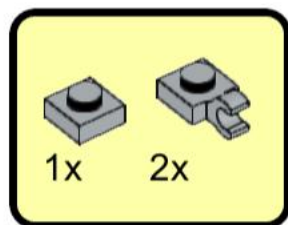

10x

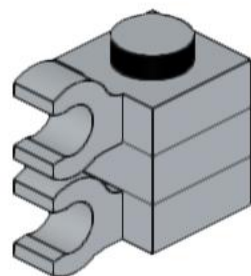

79

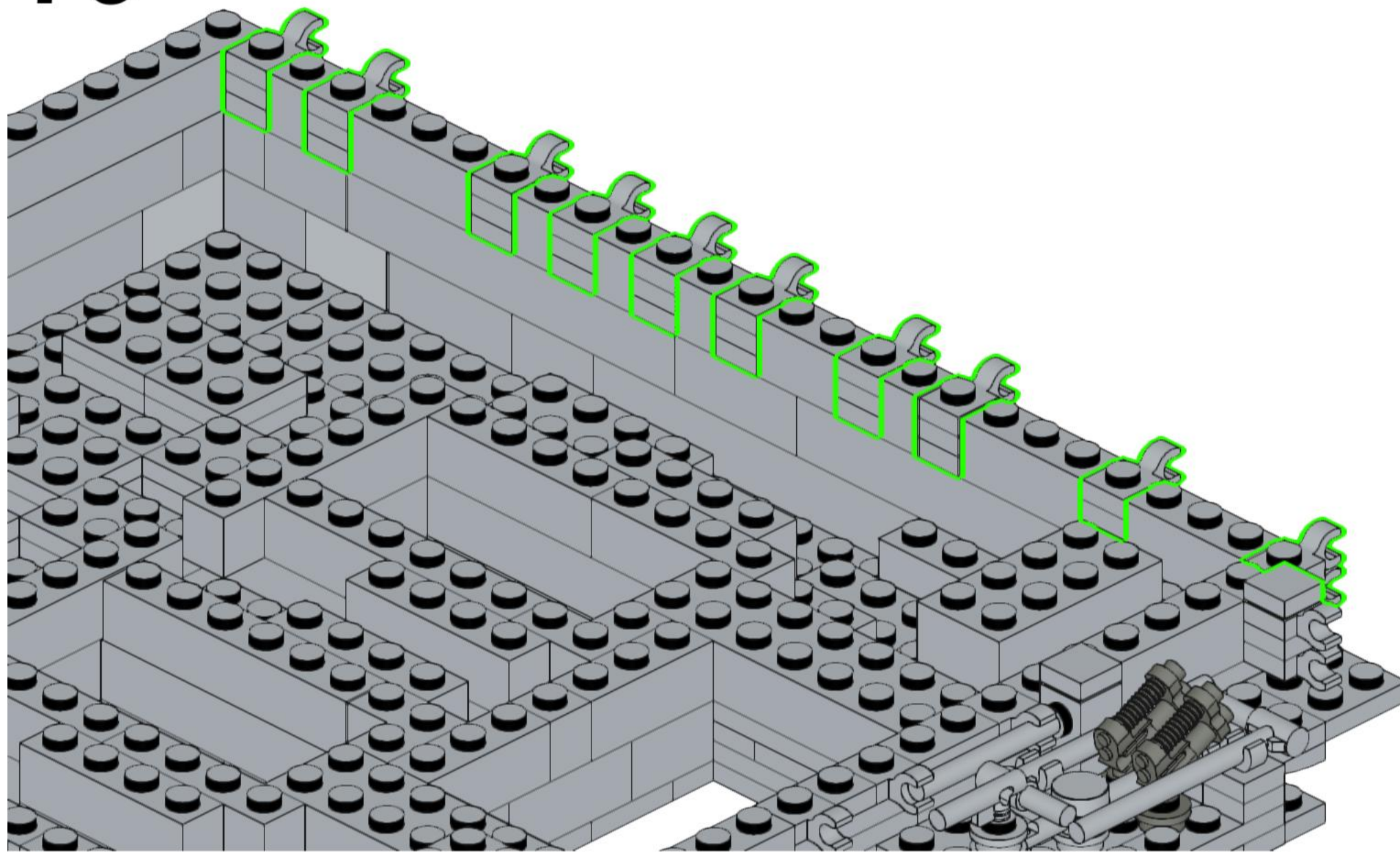

80

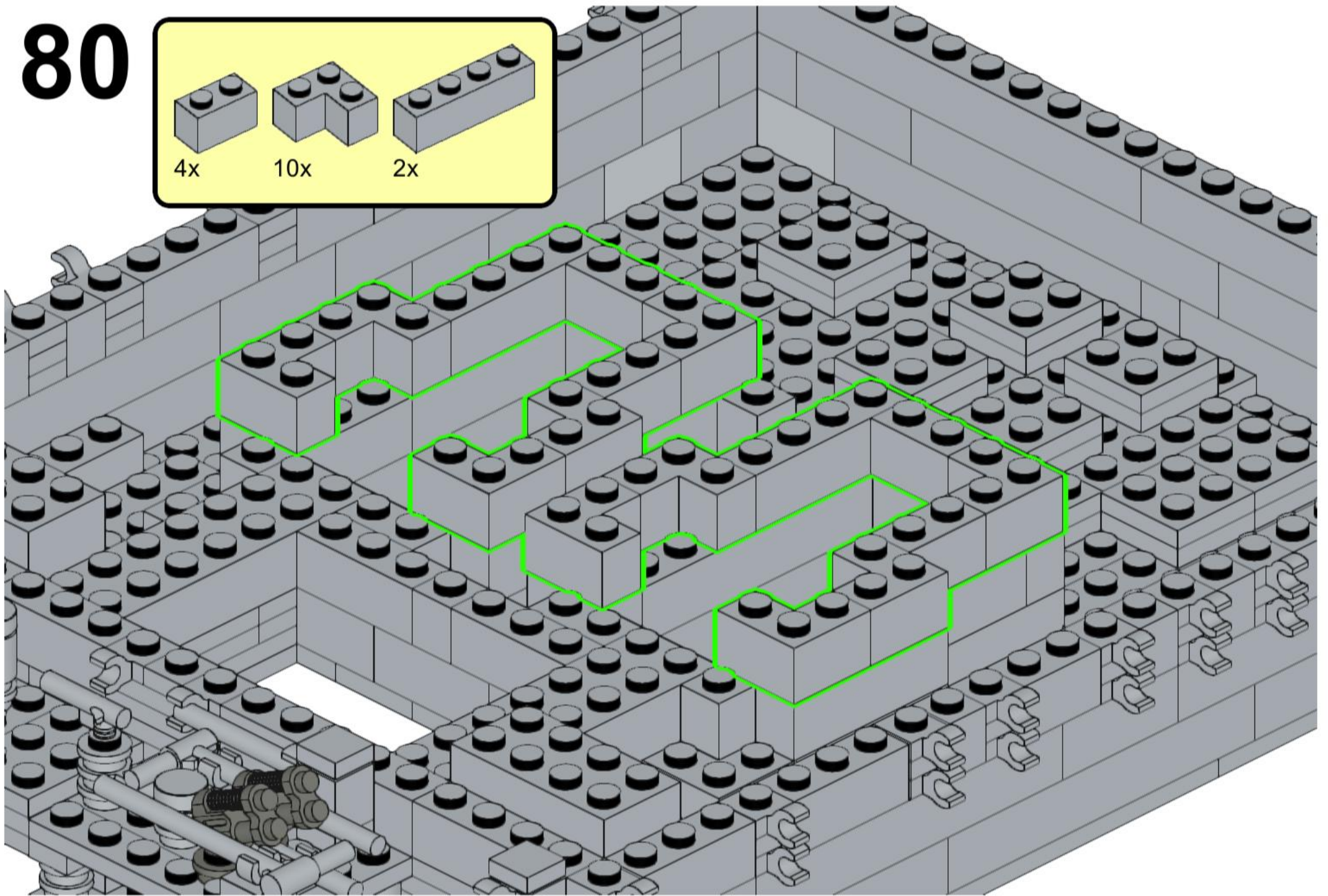
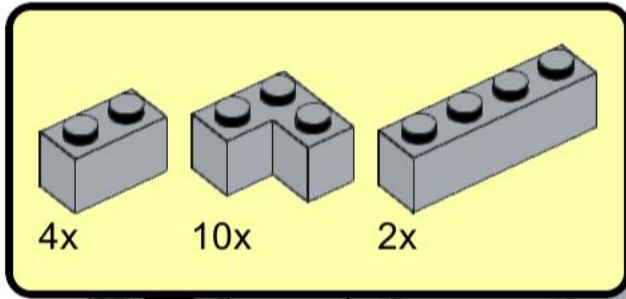

81

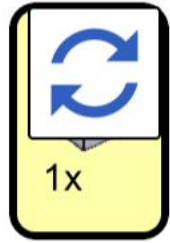

8x

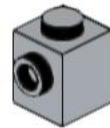
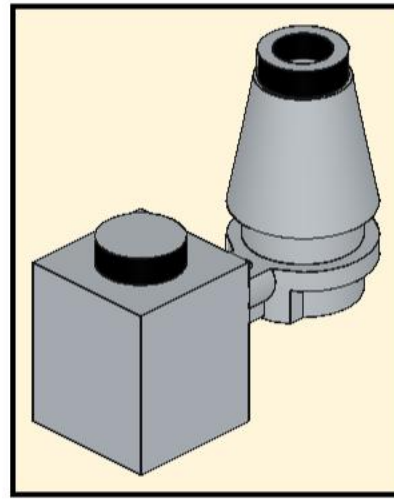

82

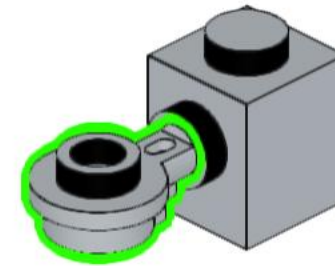
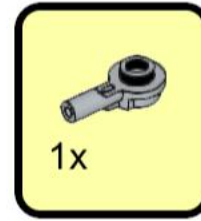

83

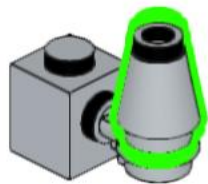

84

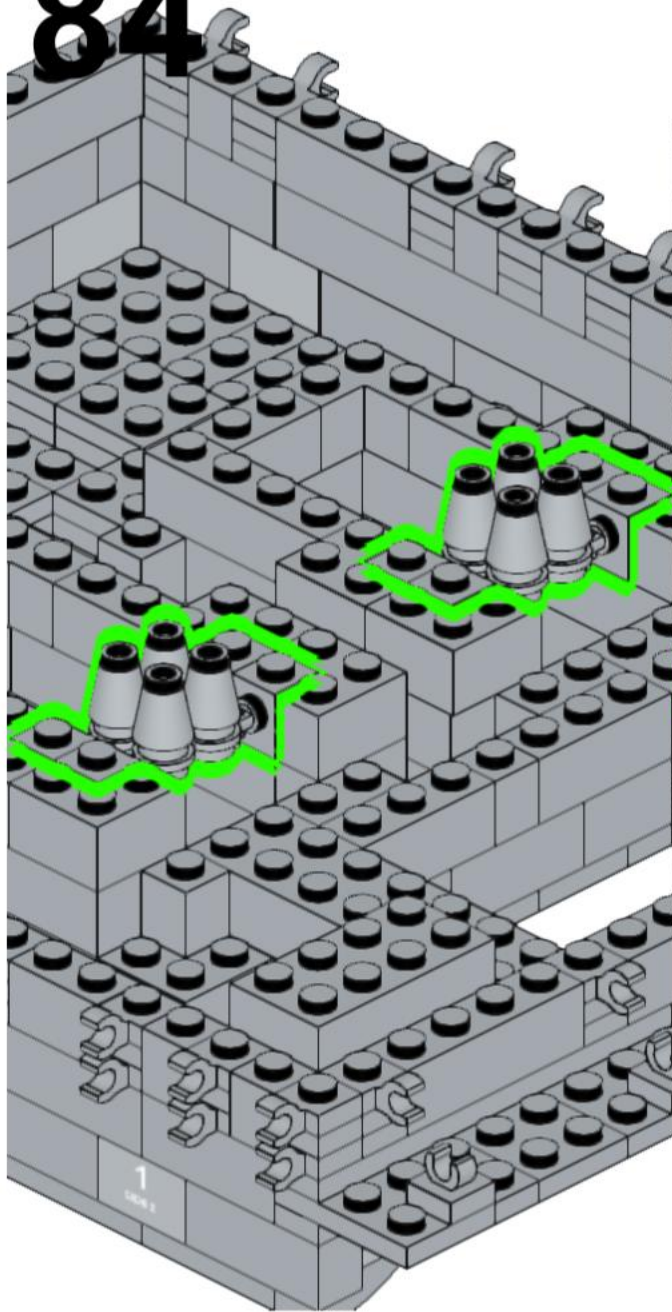

85

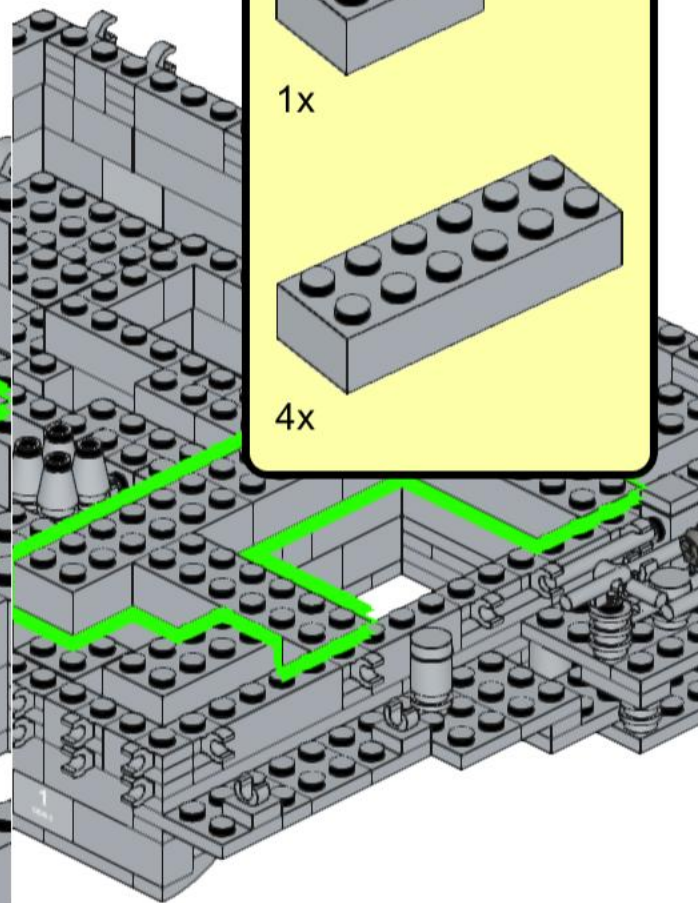
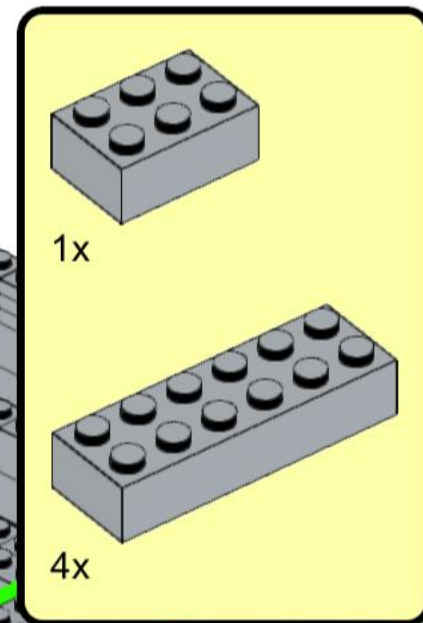

86

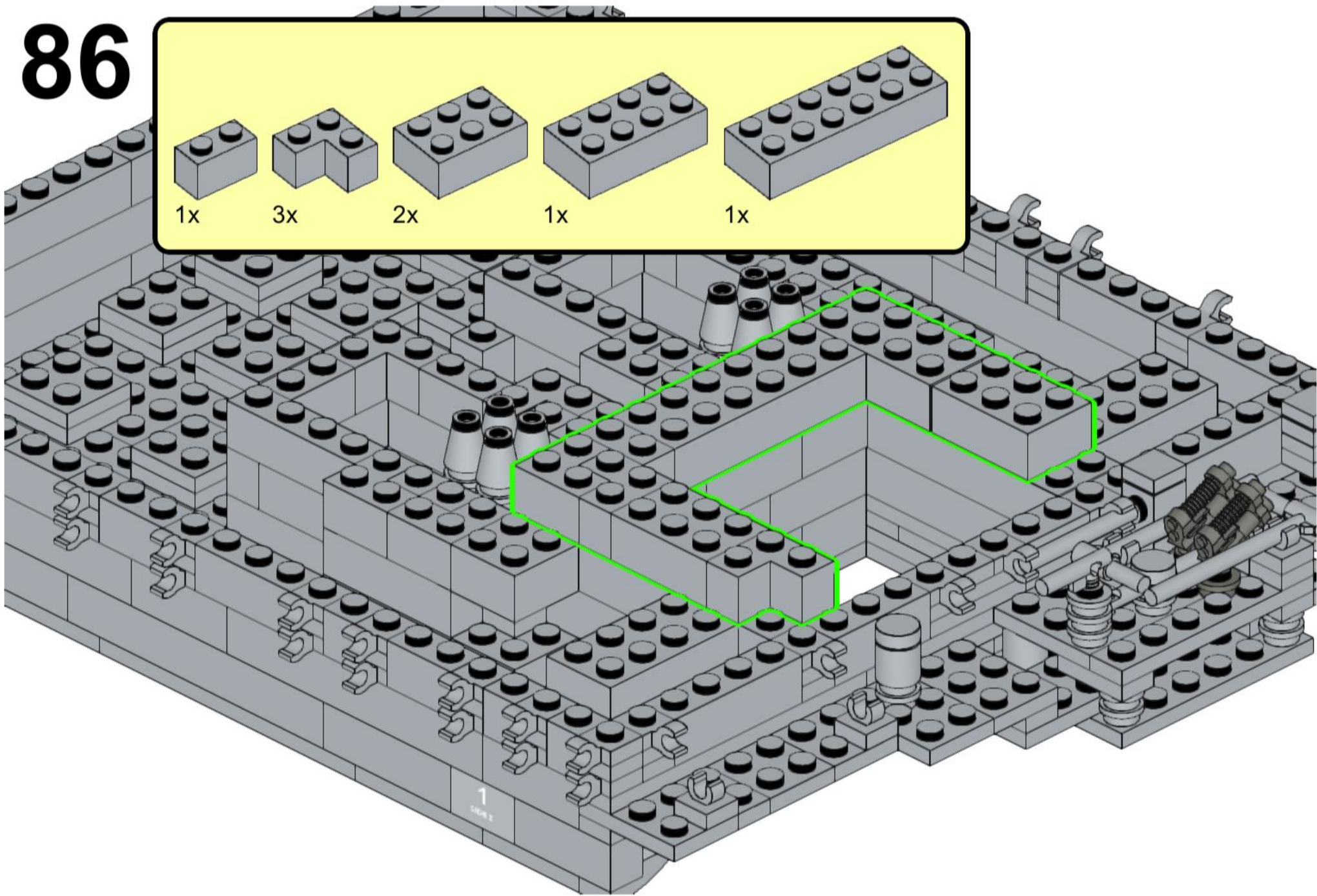
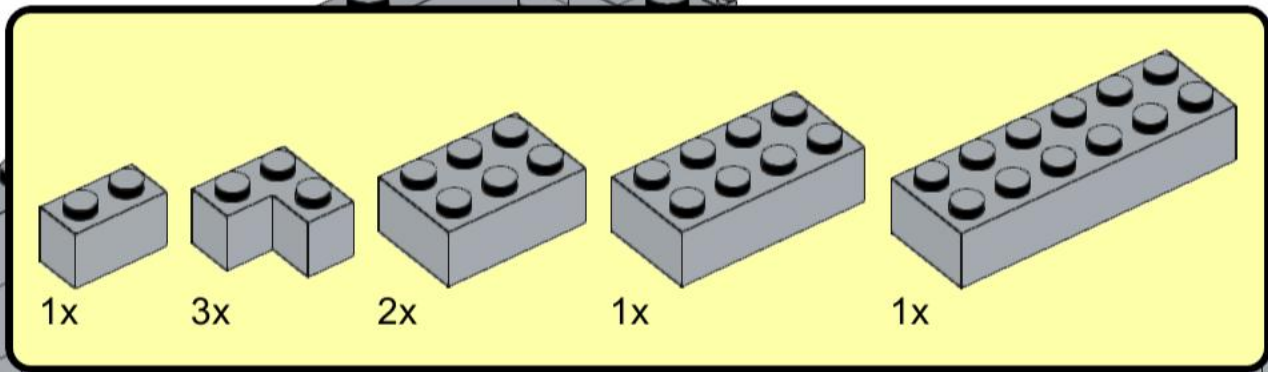

88

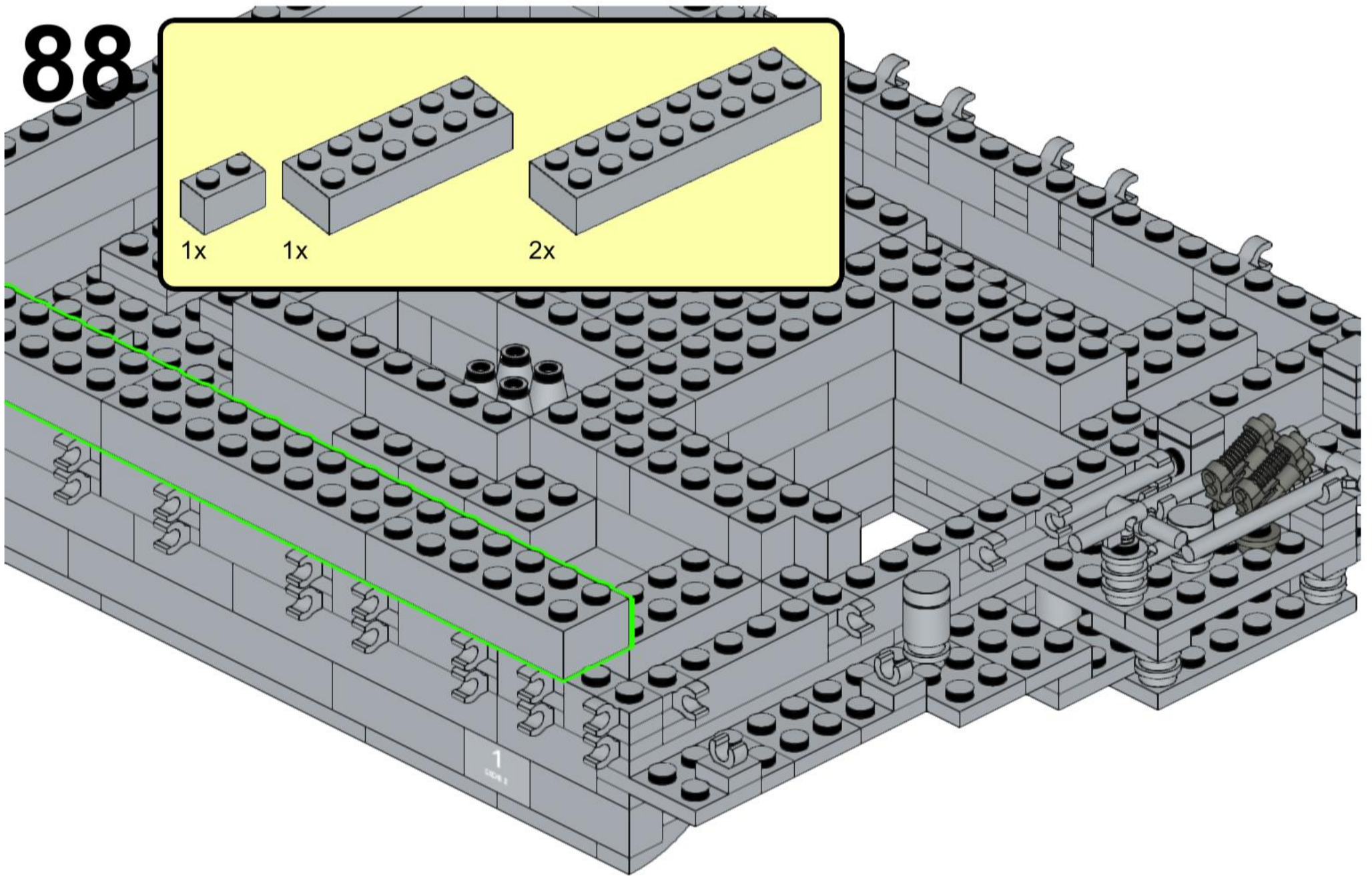
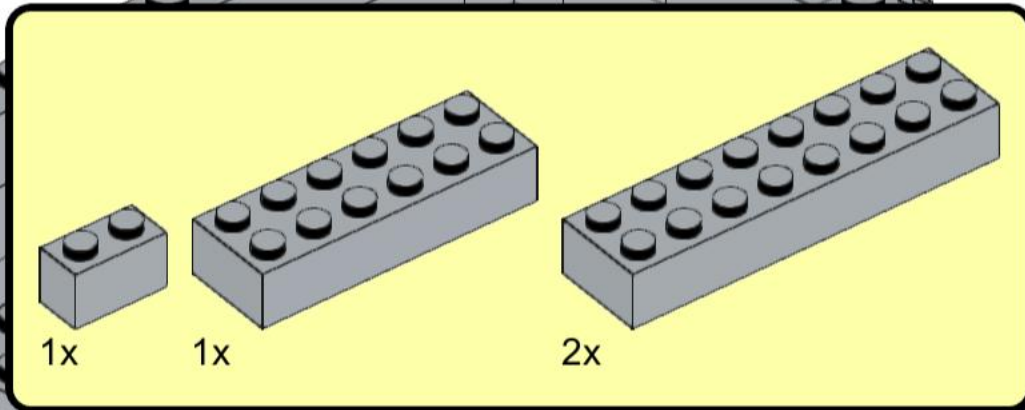

89

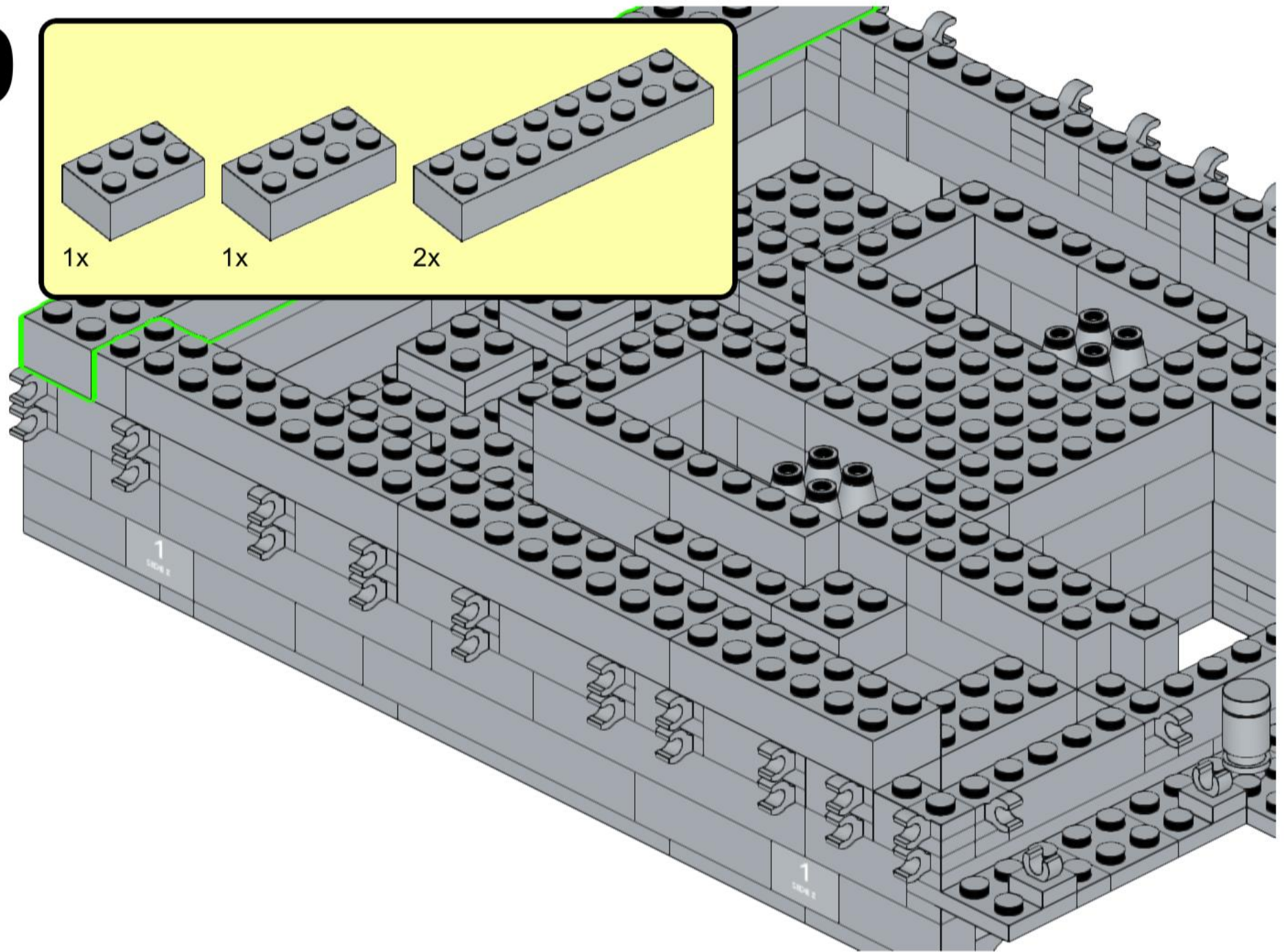
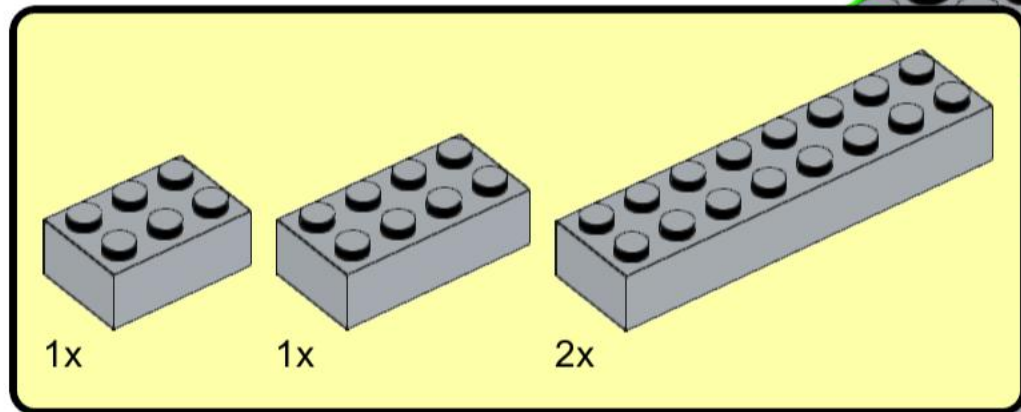

90

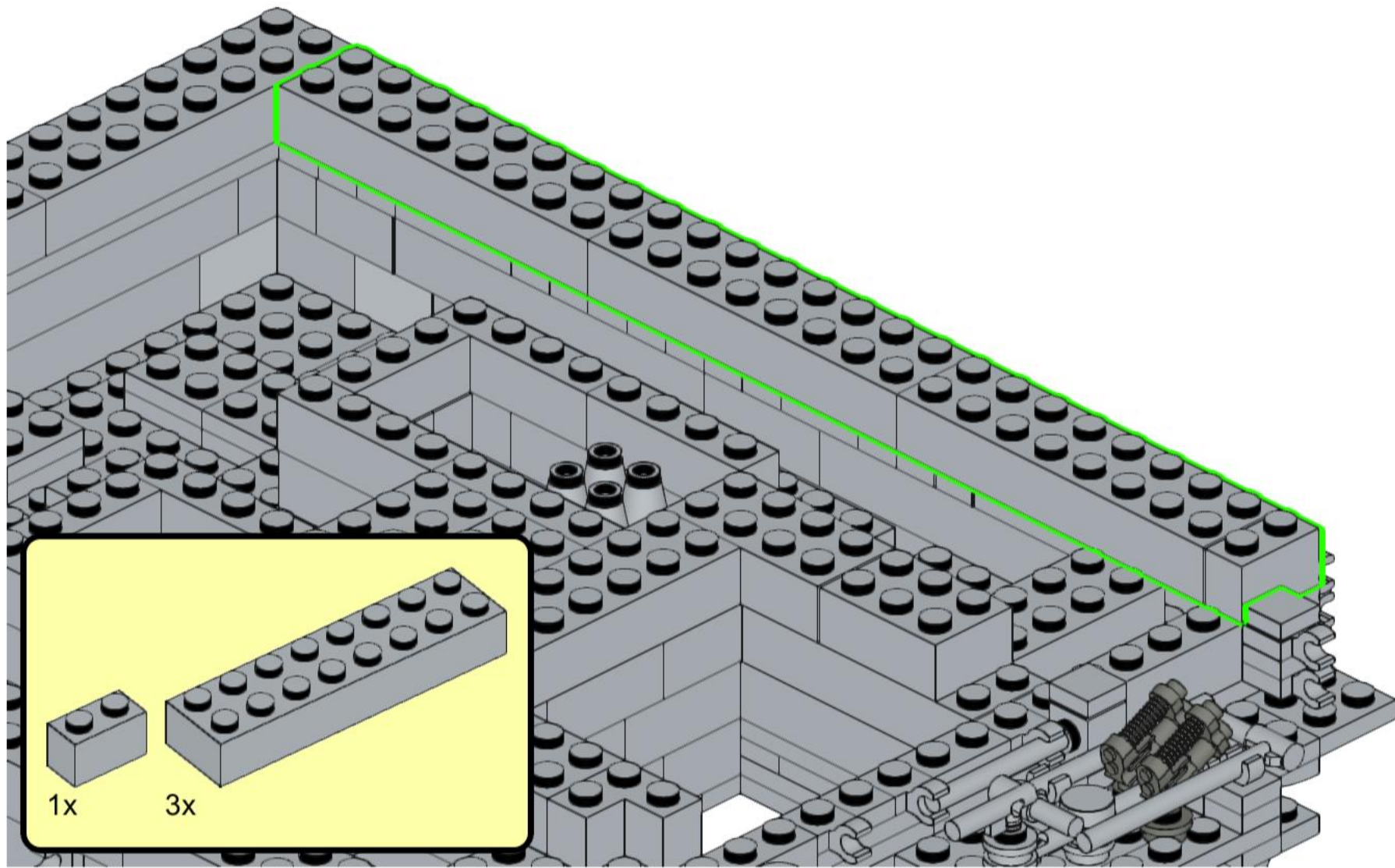

91

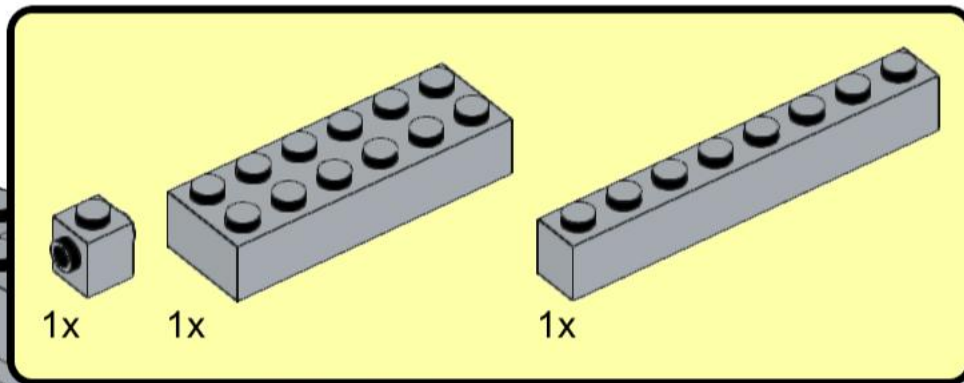
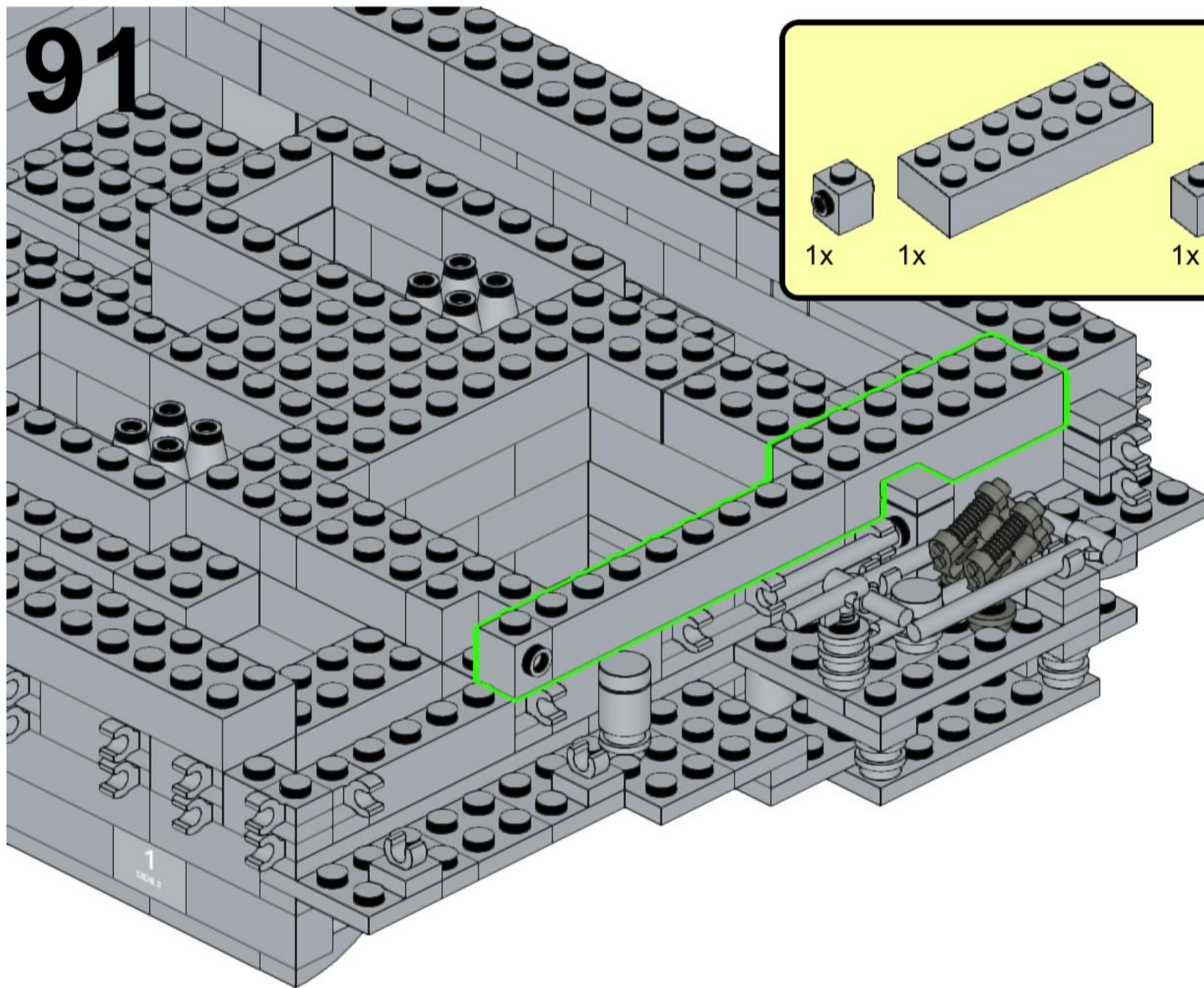

92

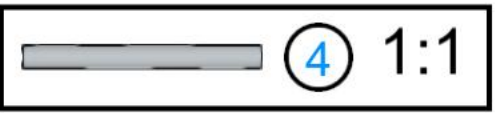
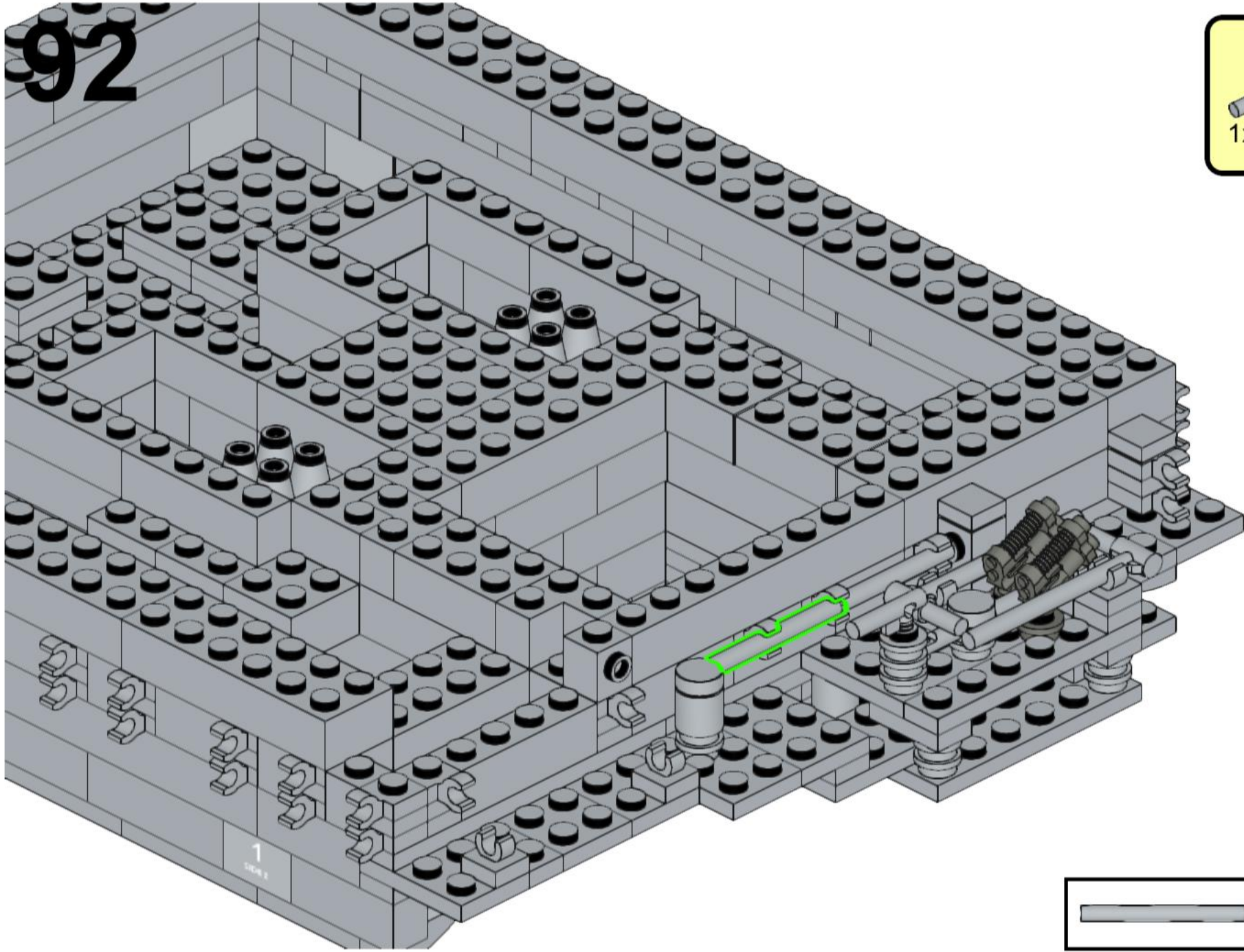
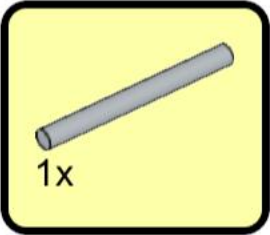

93

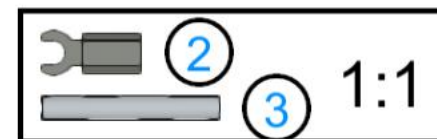
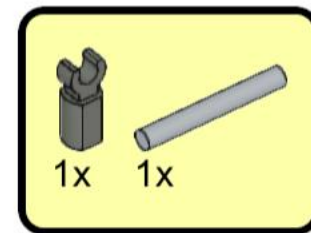
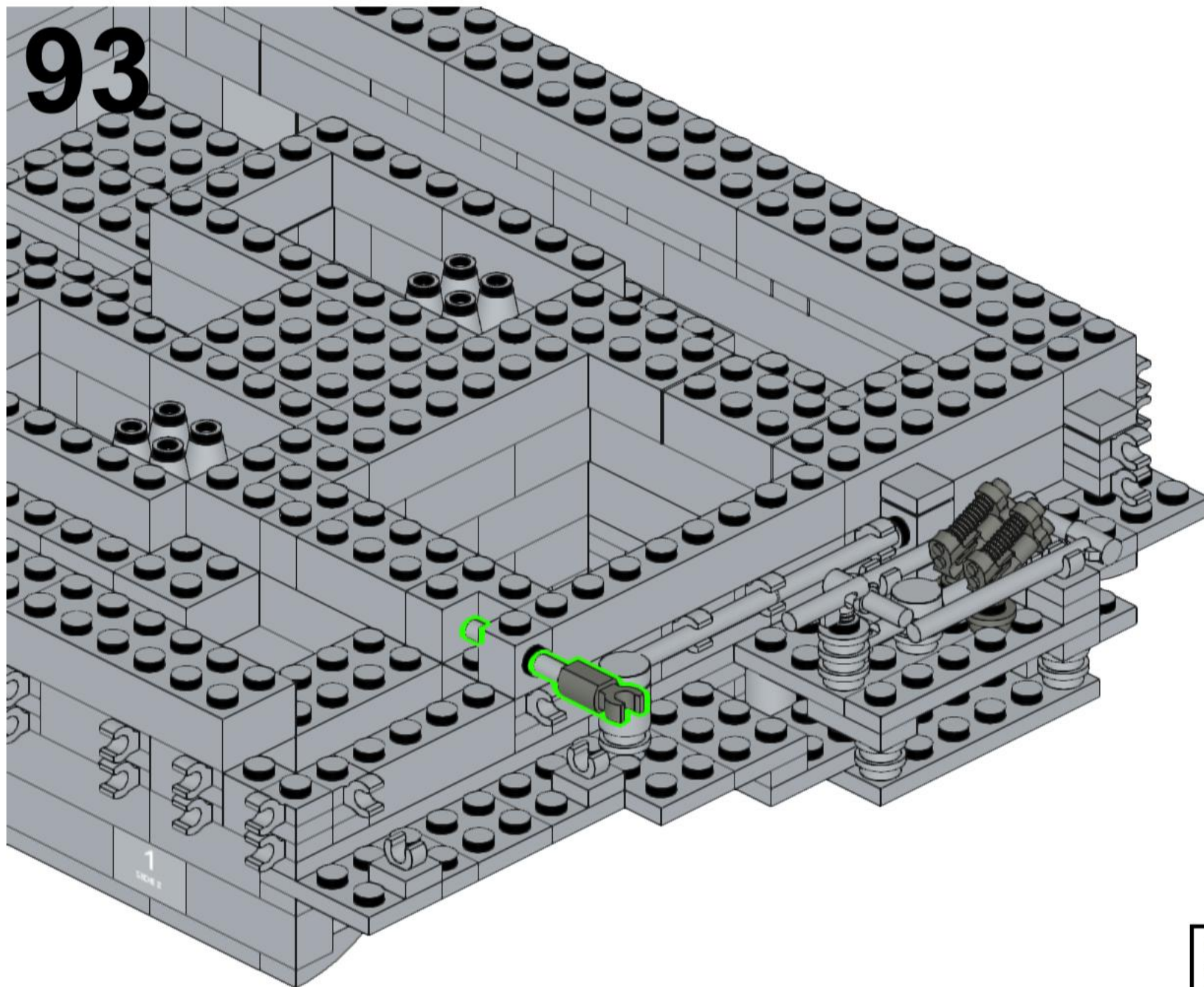

94

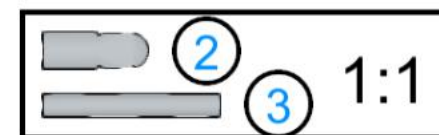
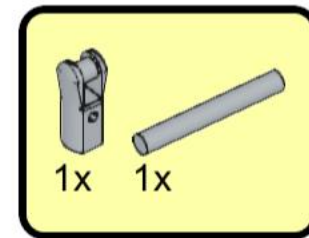
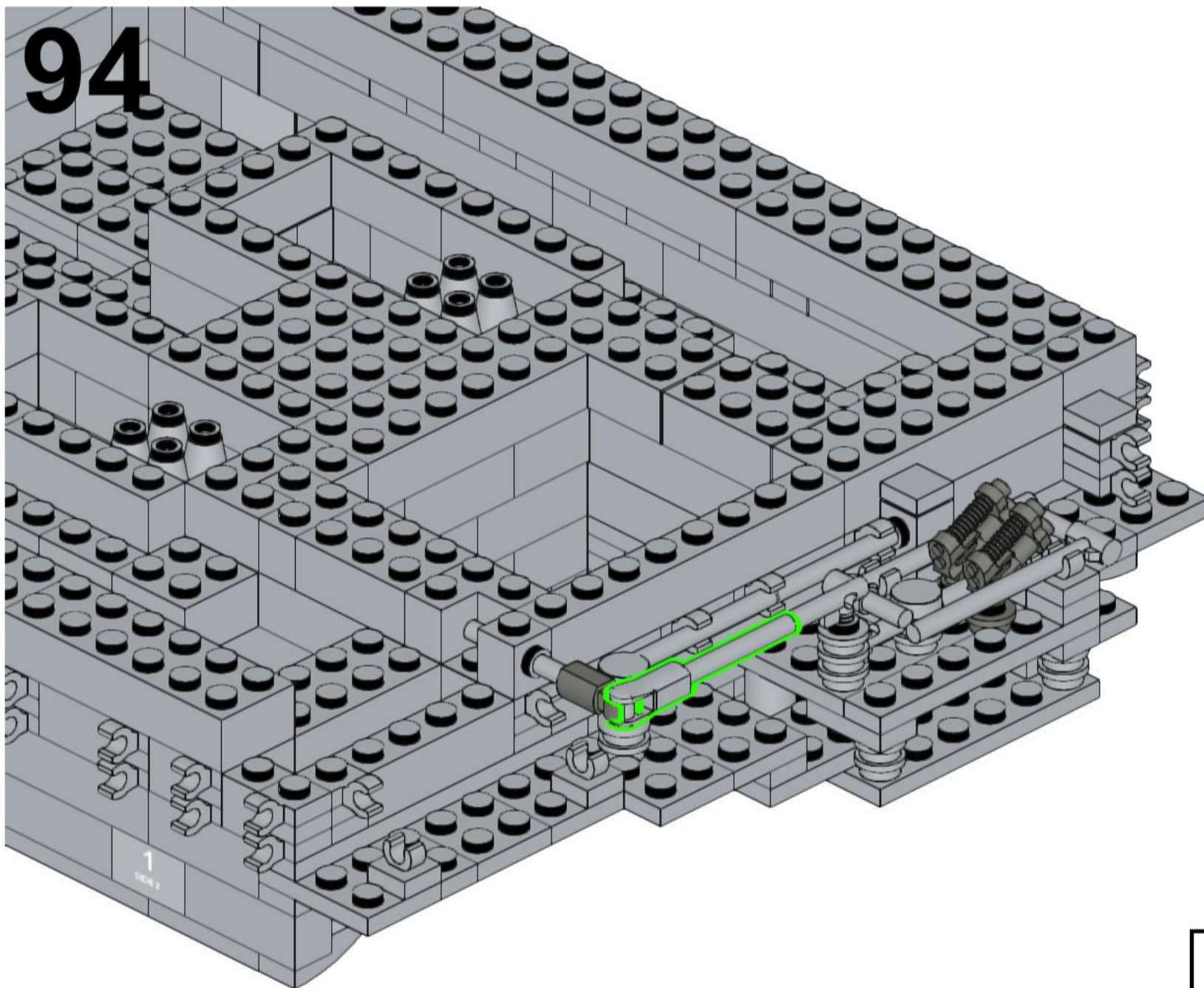

95

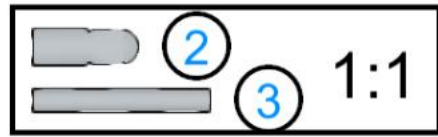
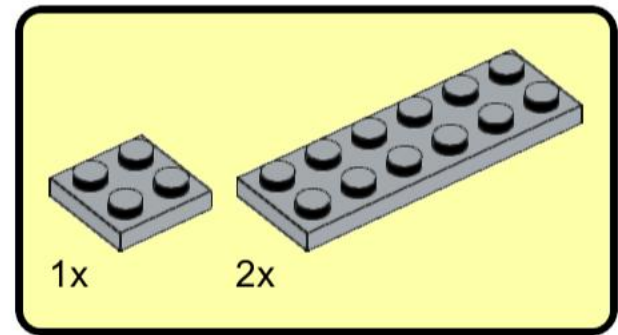
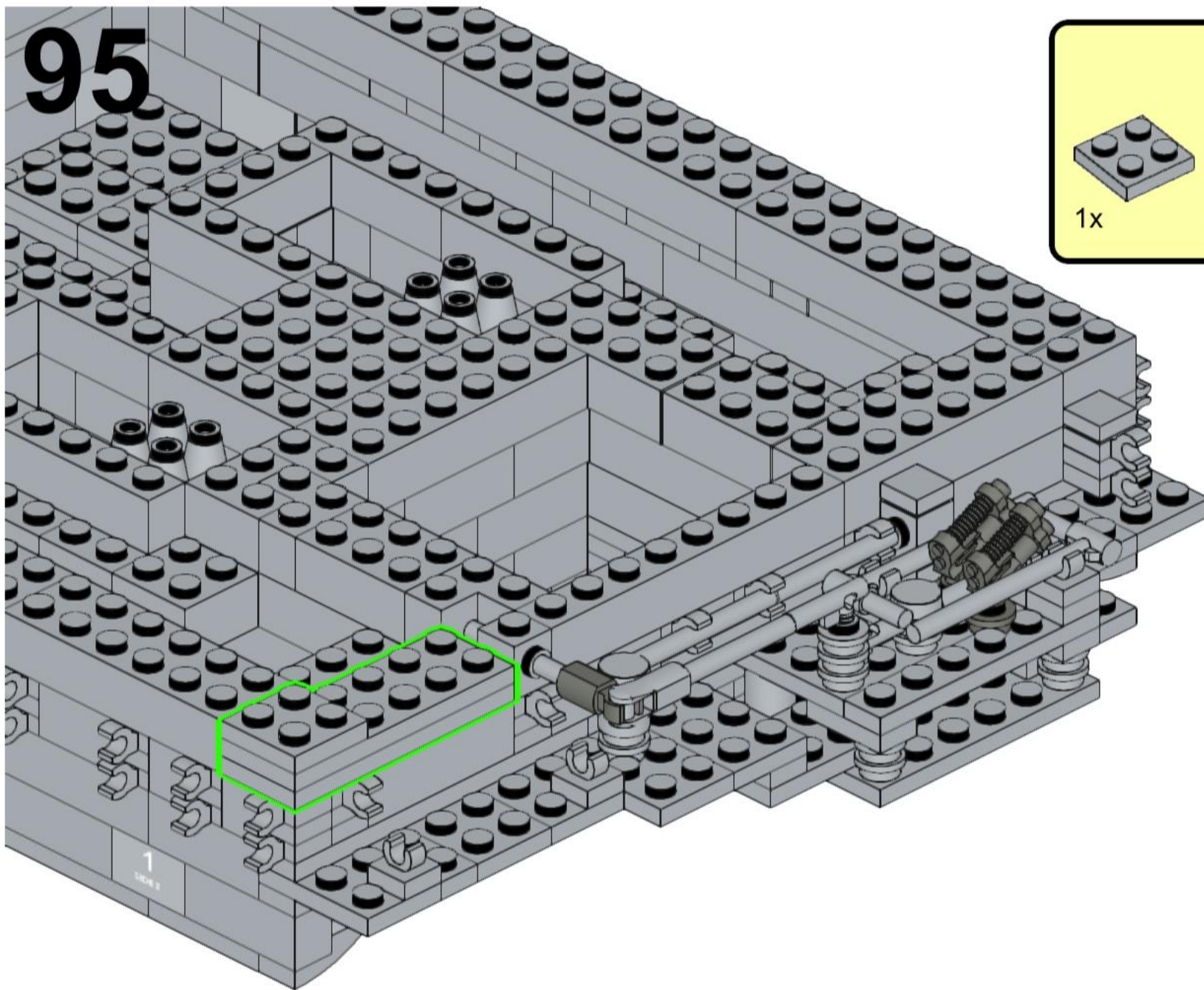

96

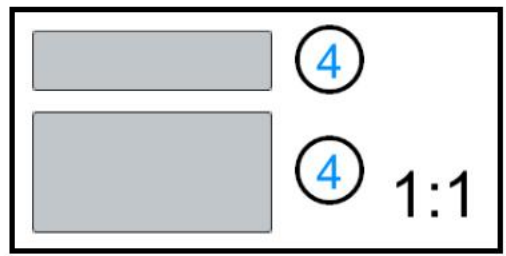
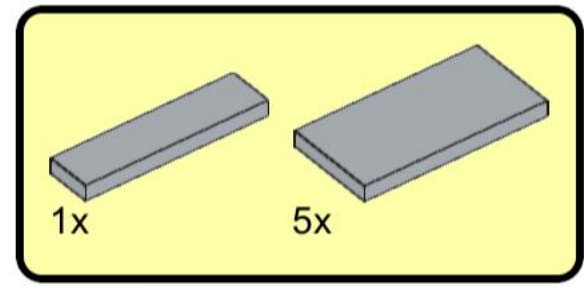
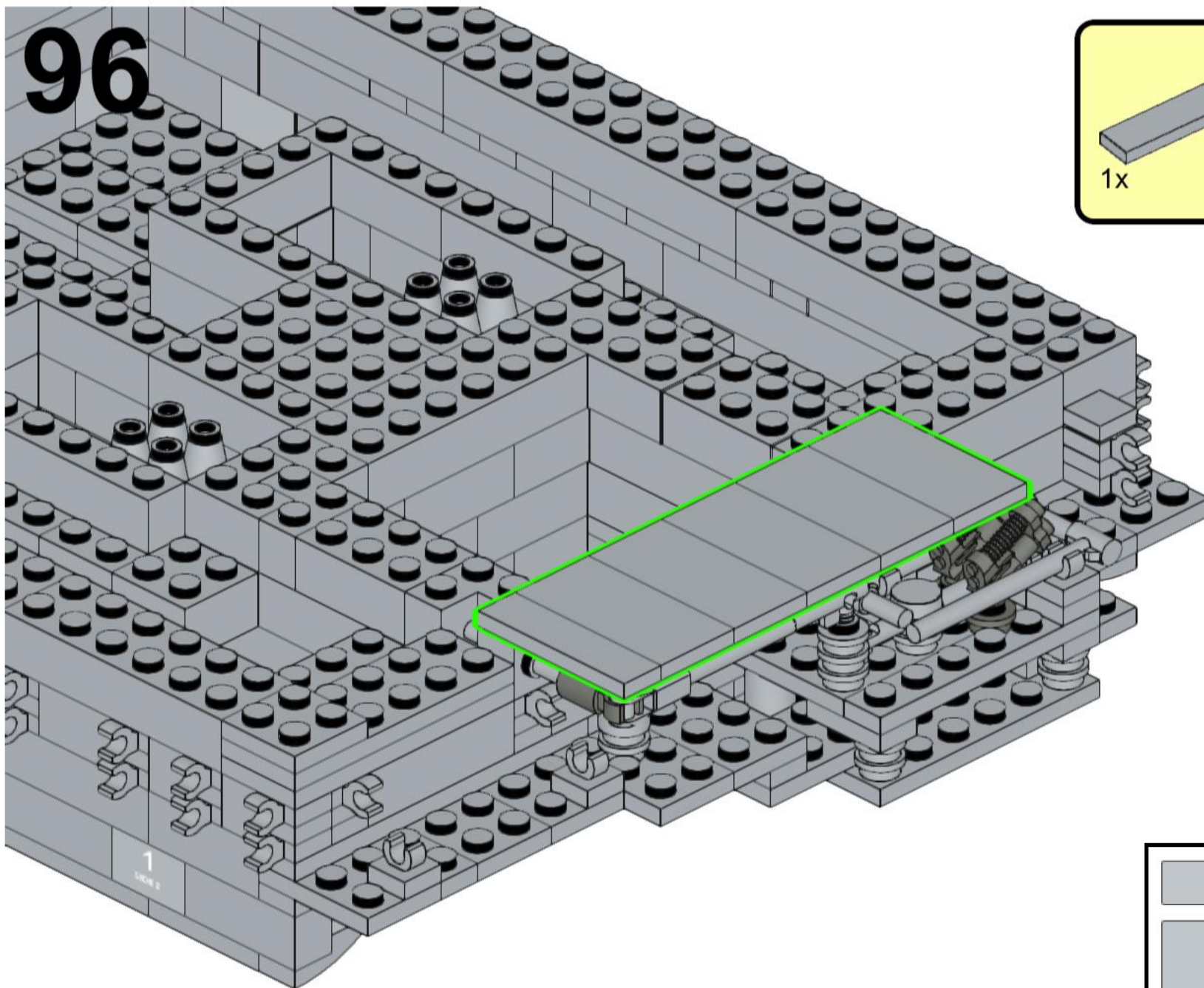

97

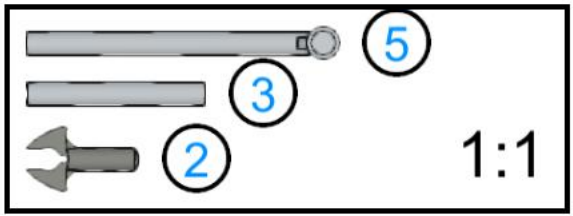
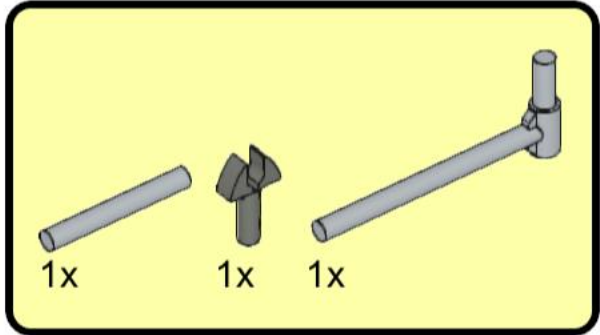
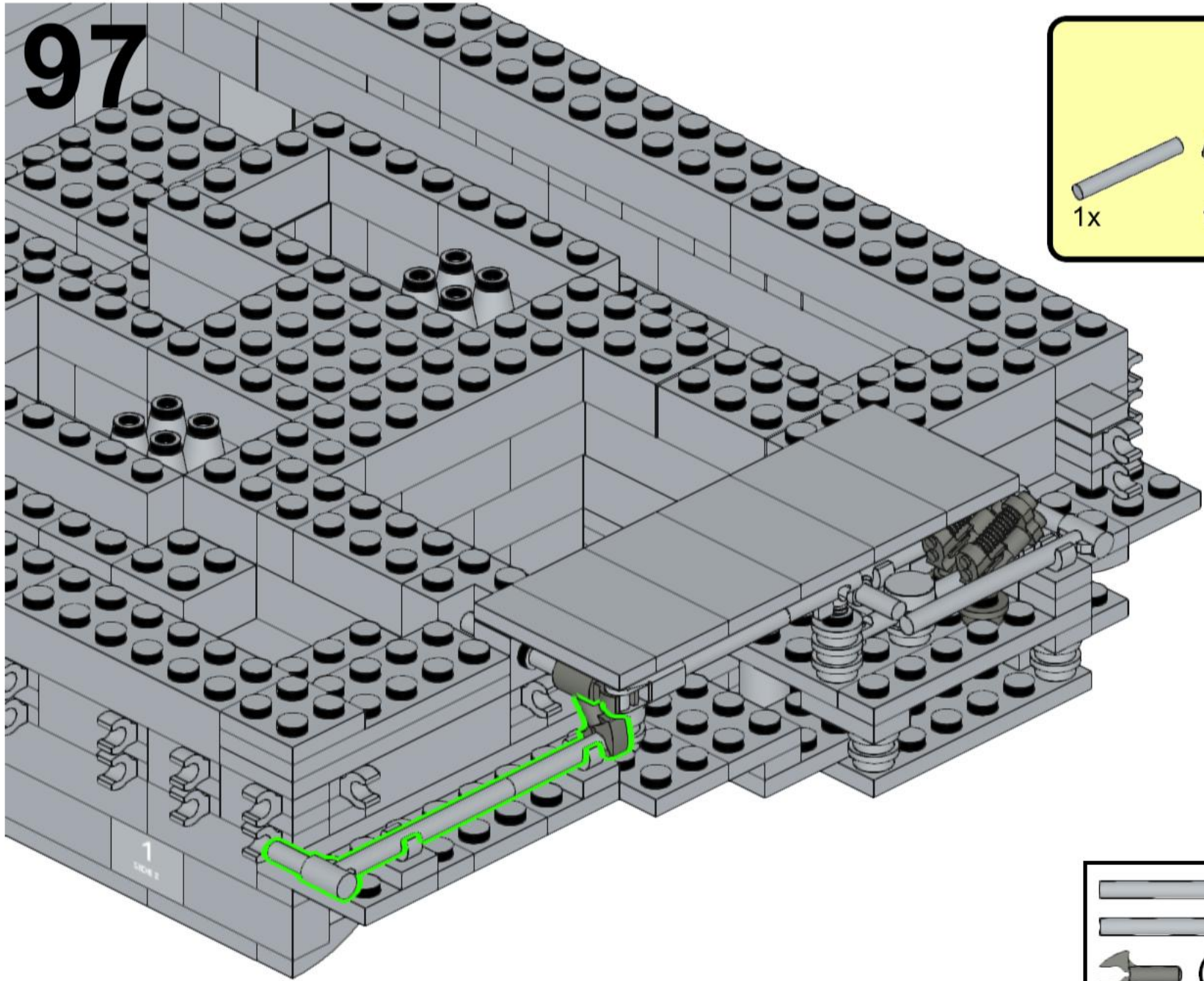

98

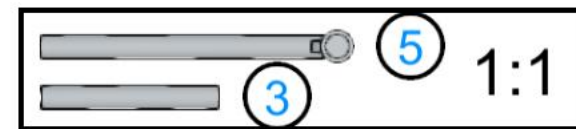
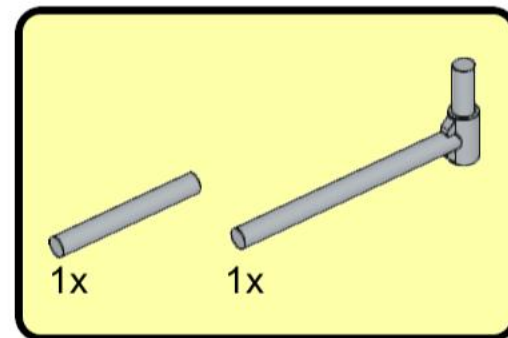
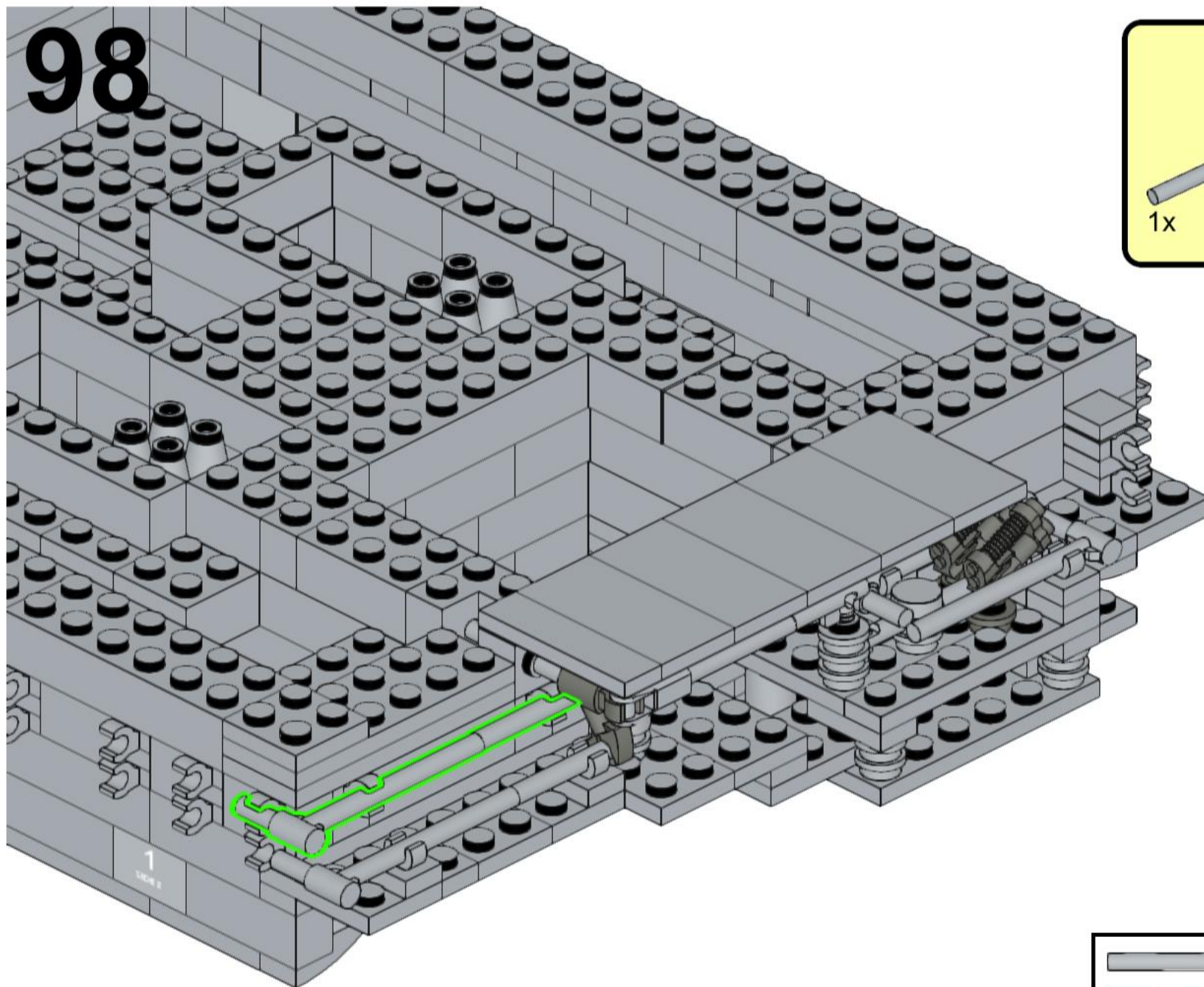

99

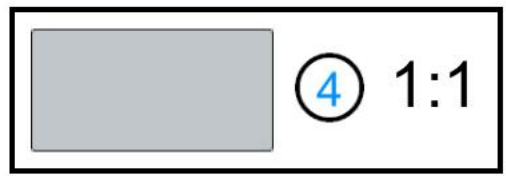
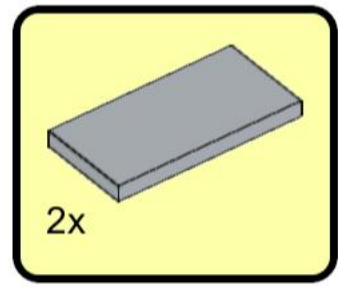
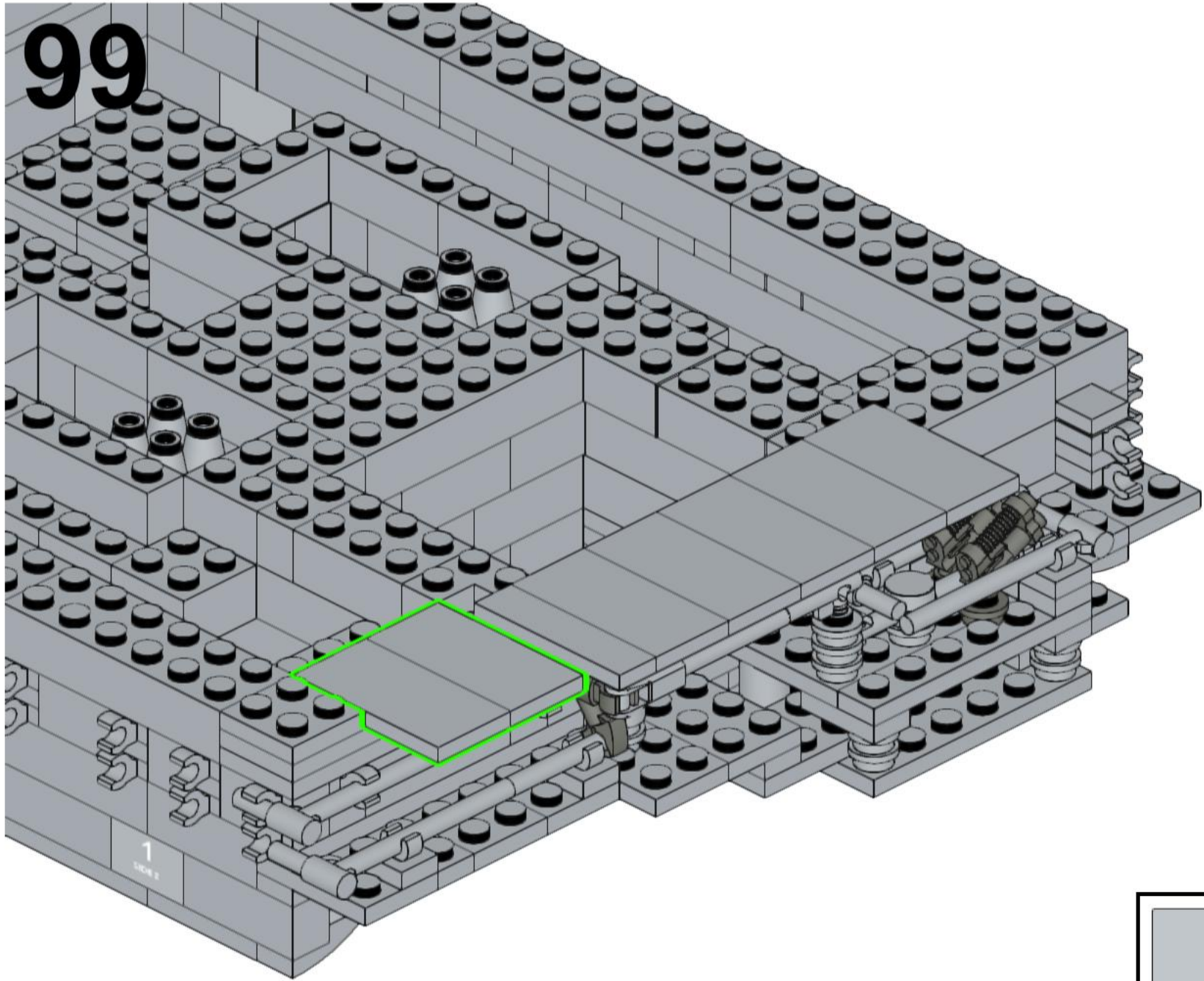

100

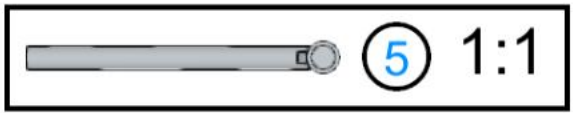
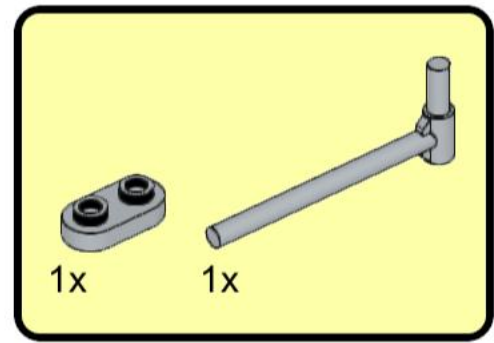
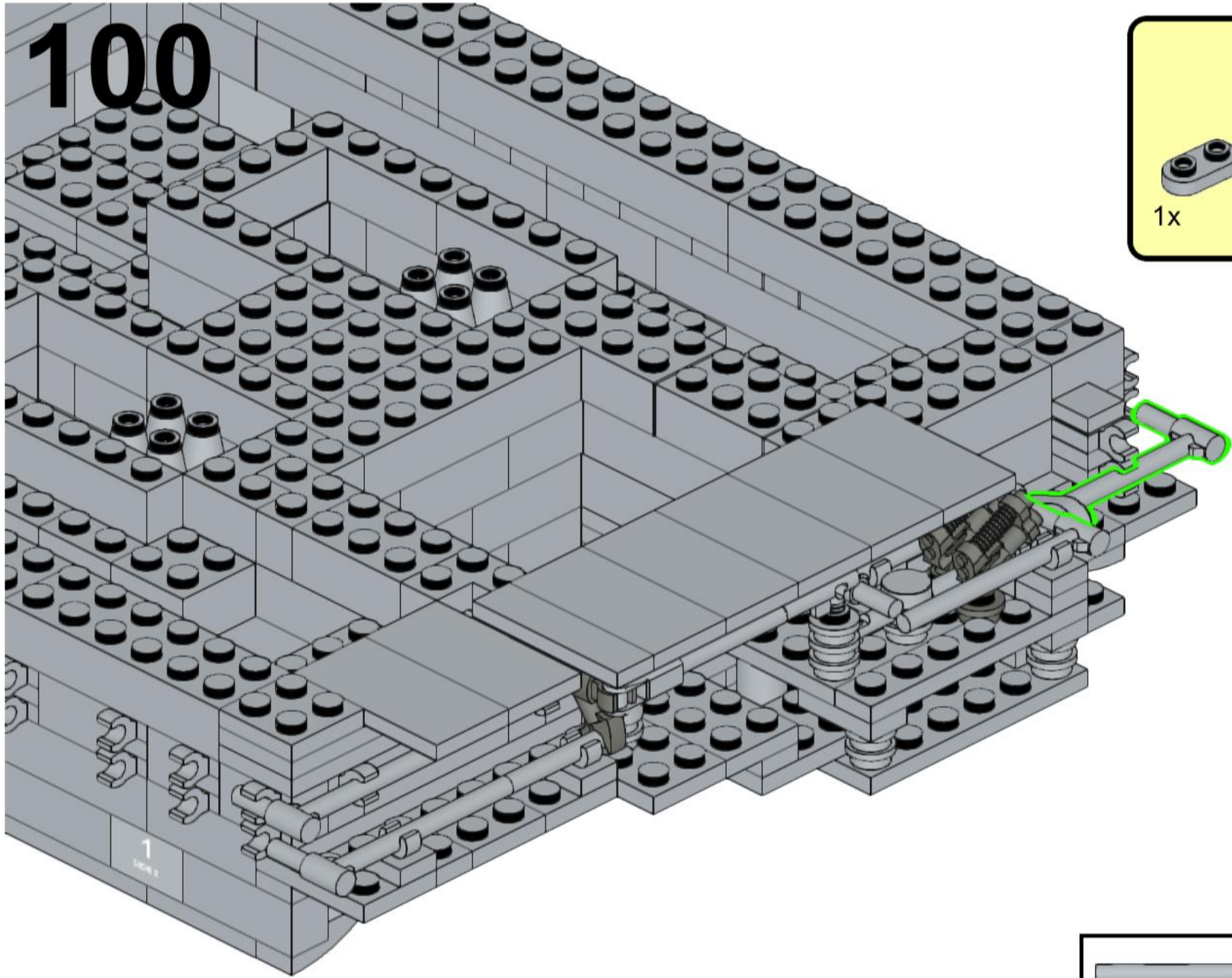

101

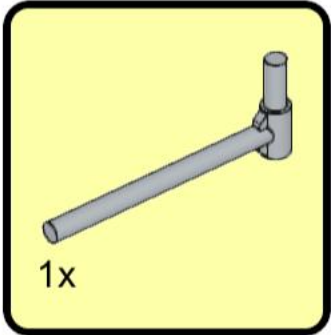
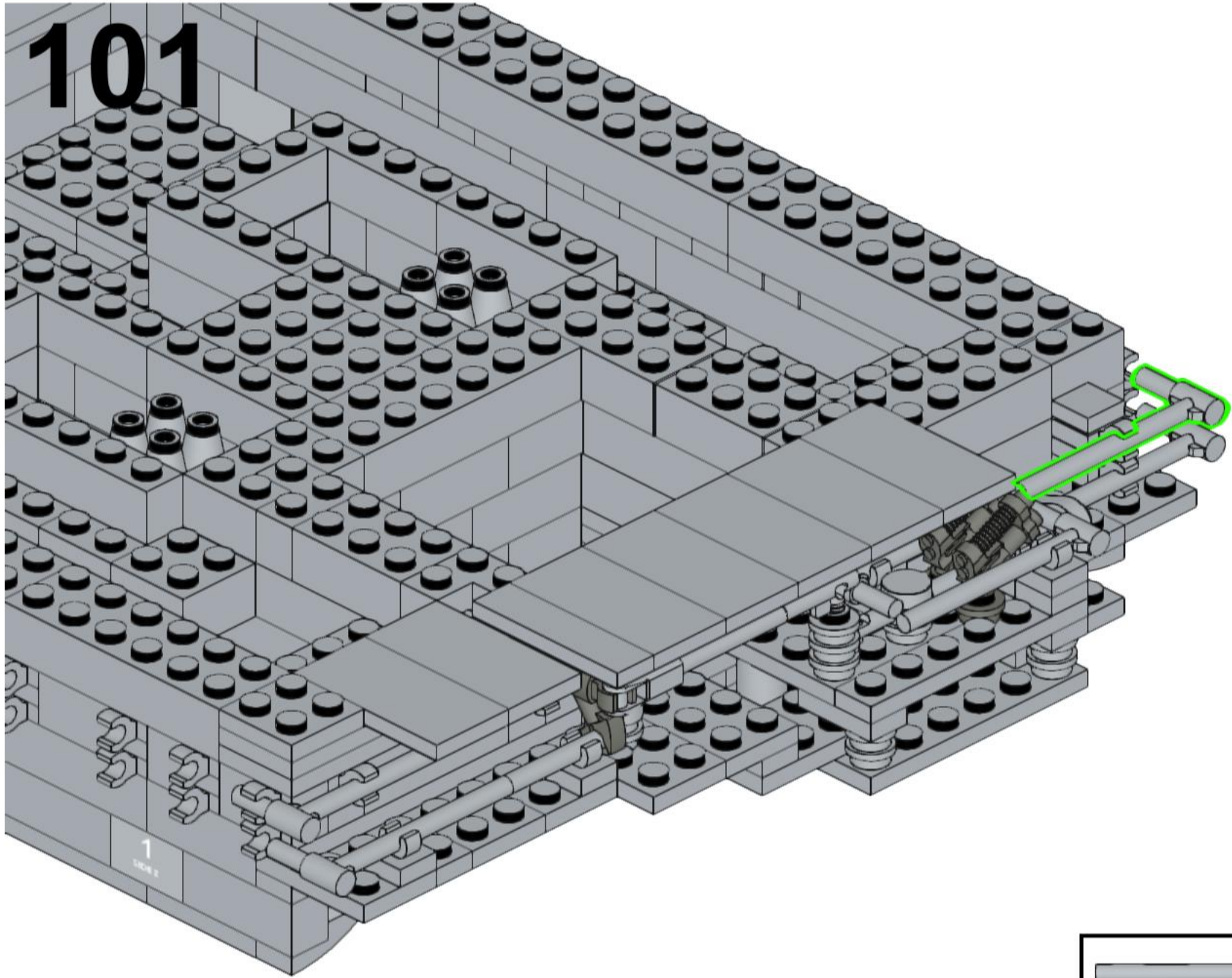

102

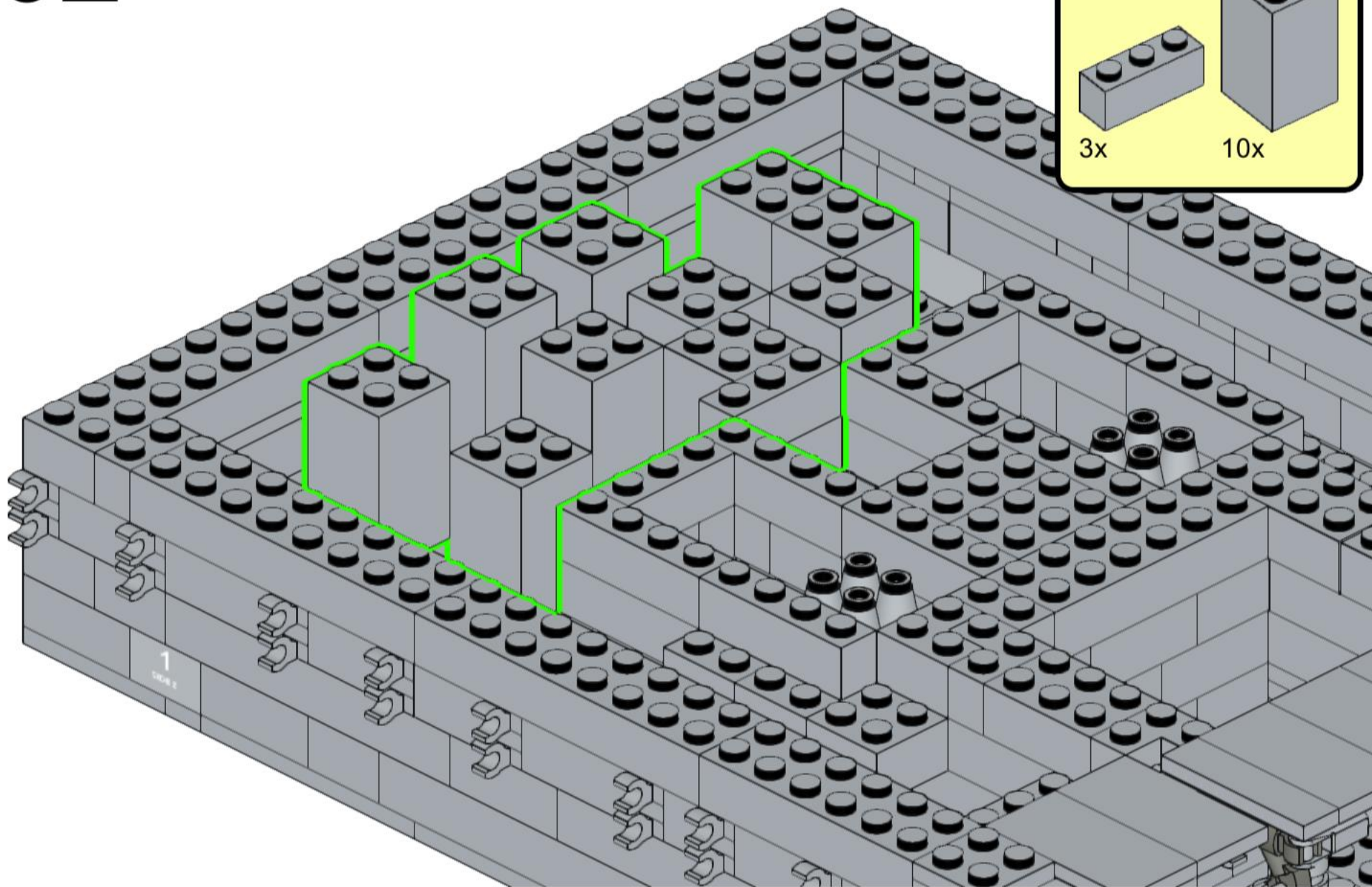
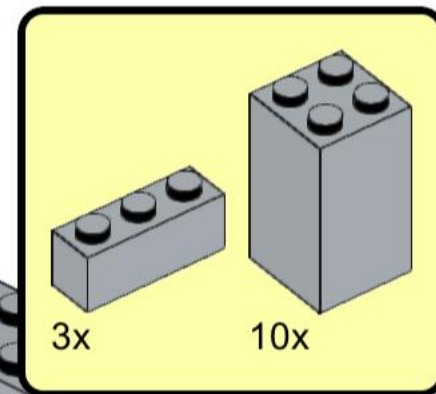

103

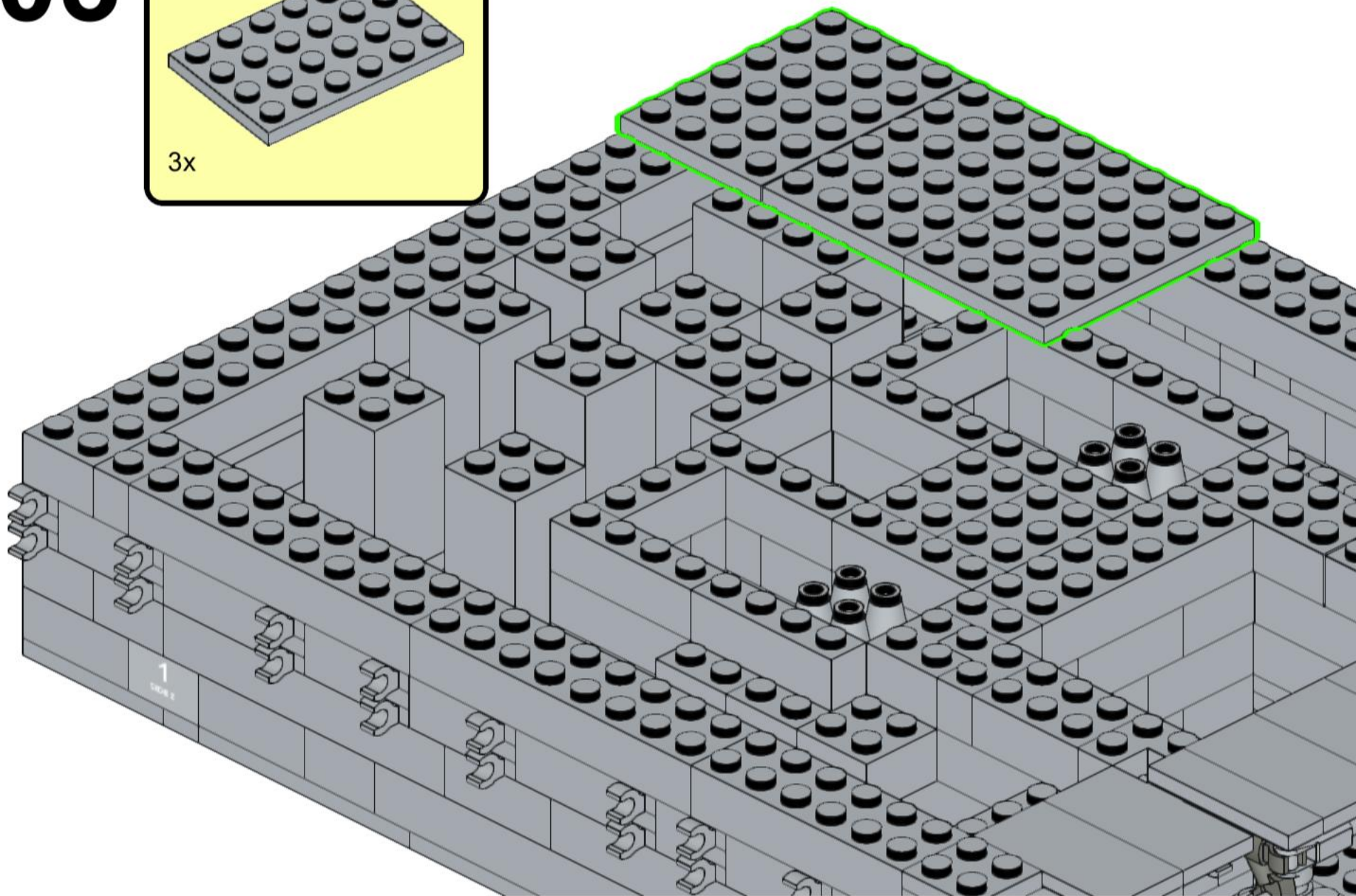
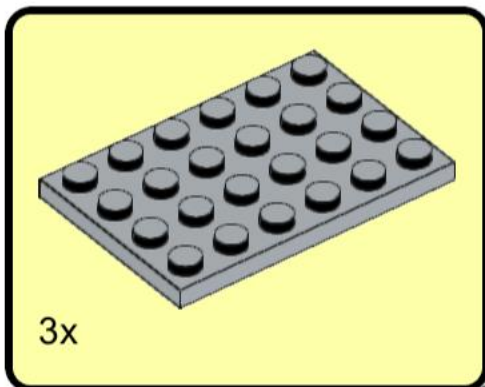

104

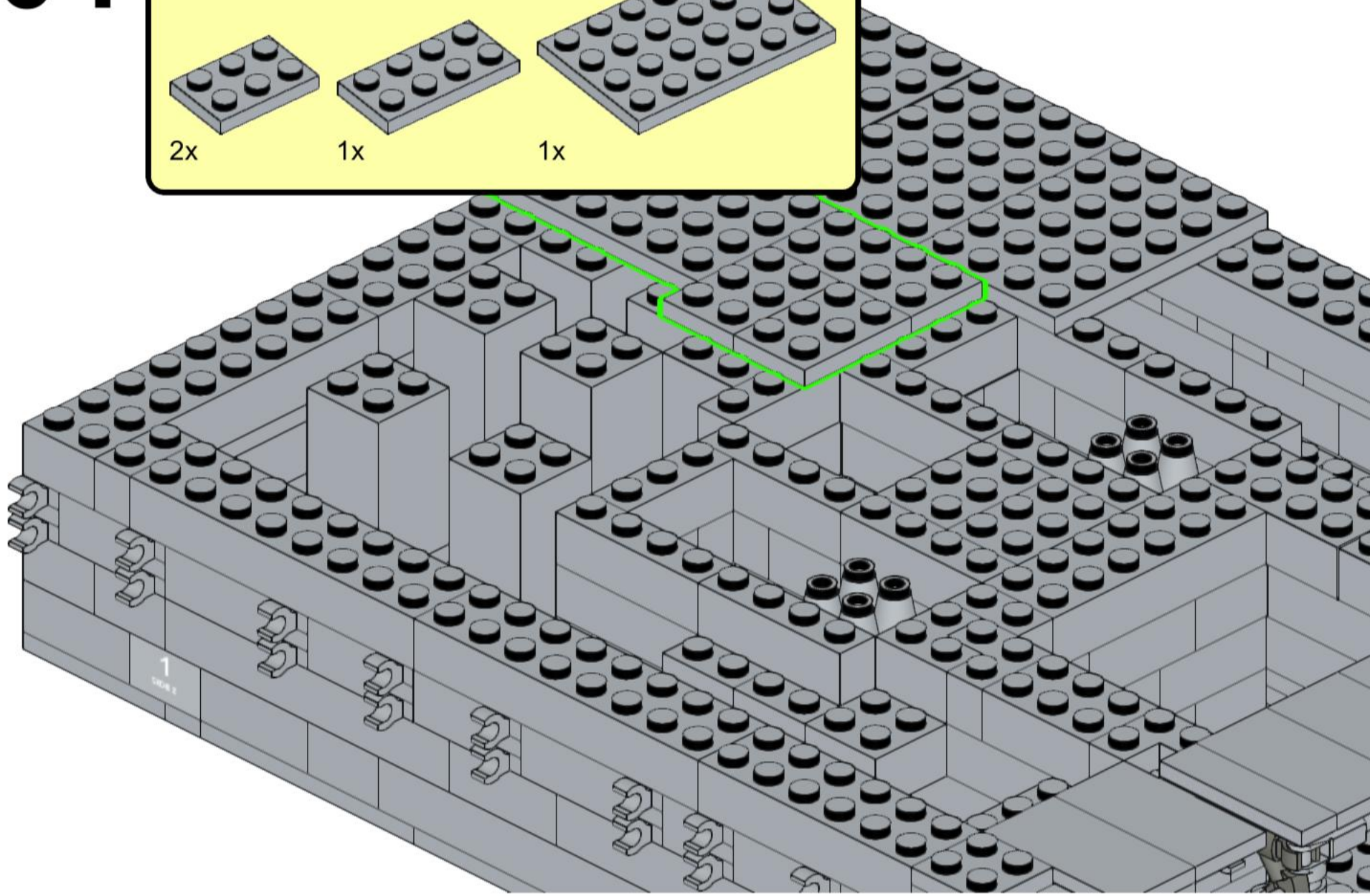
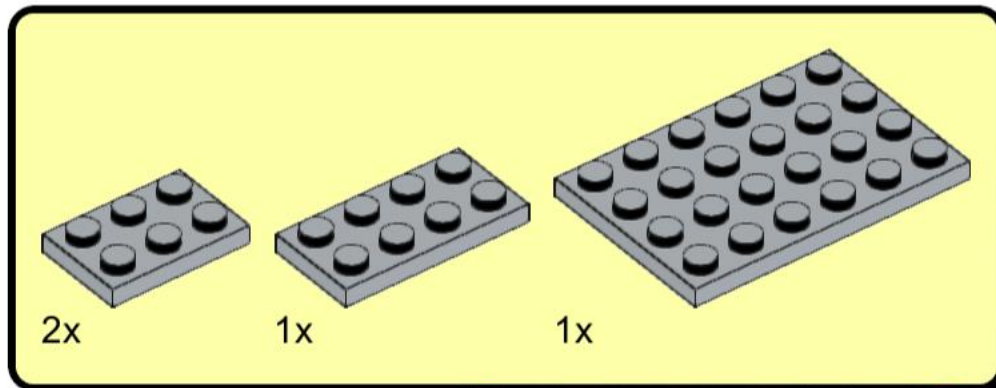

105

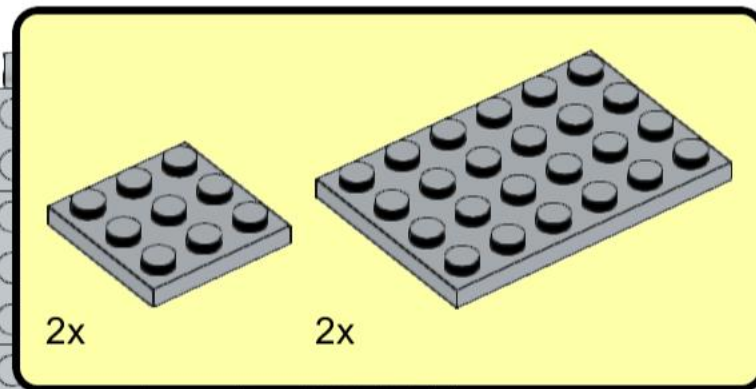
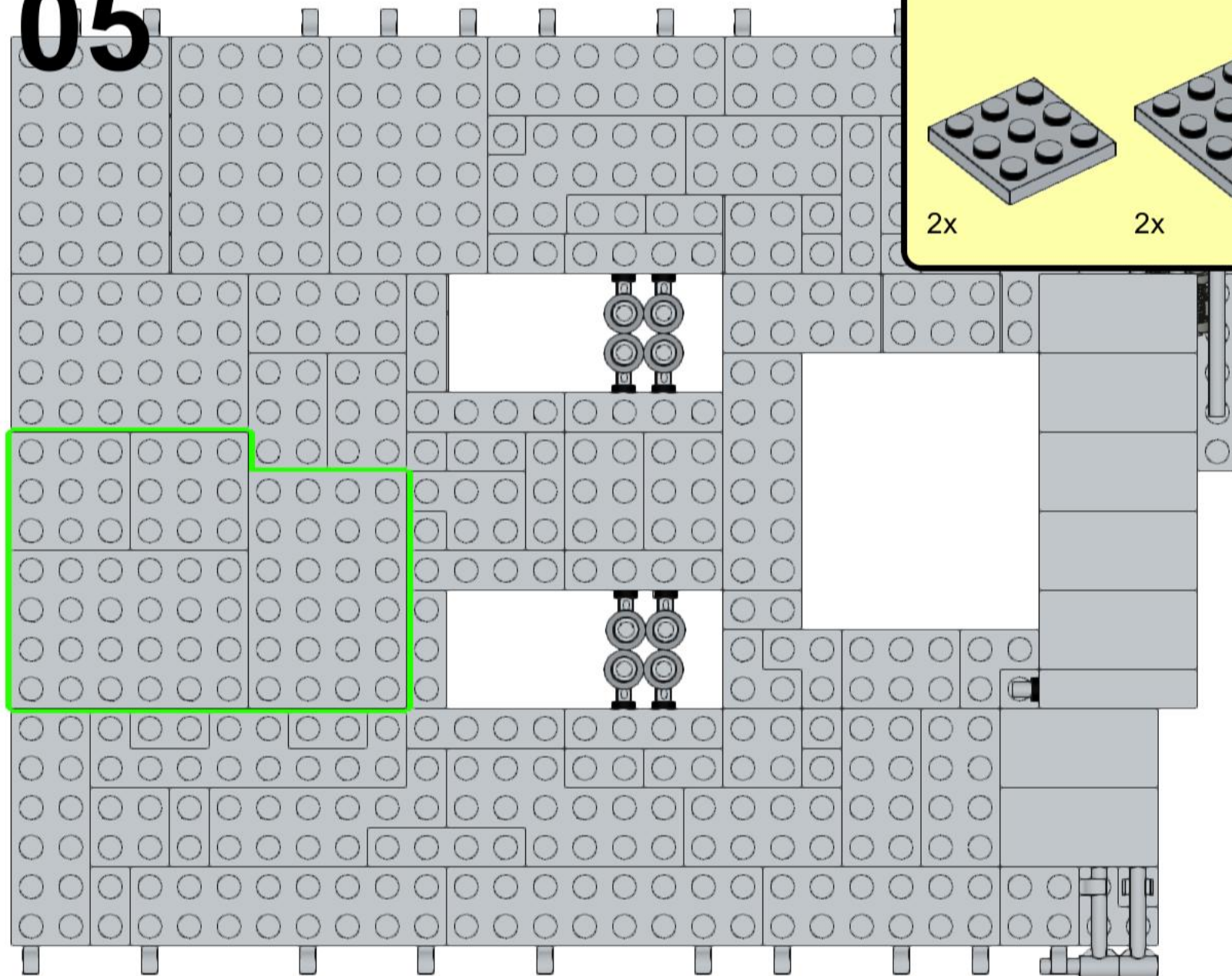

106

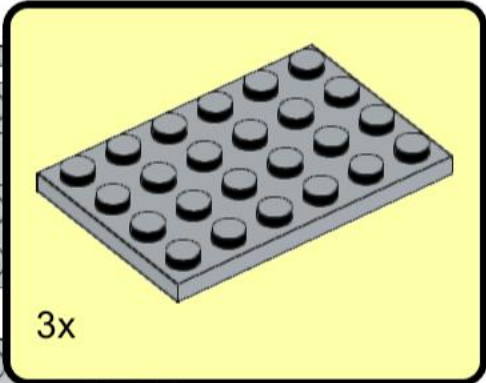
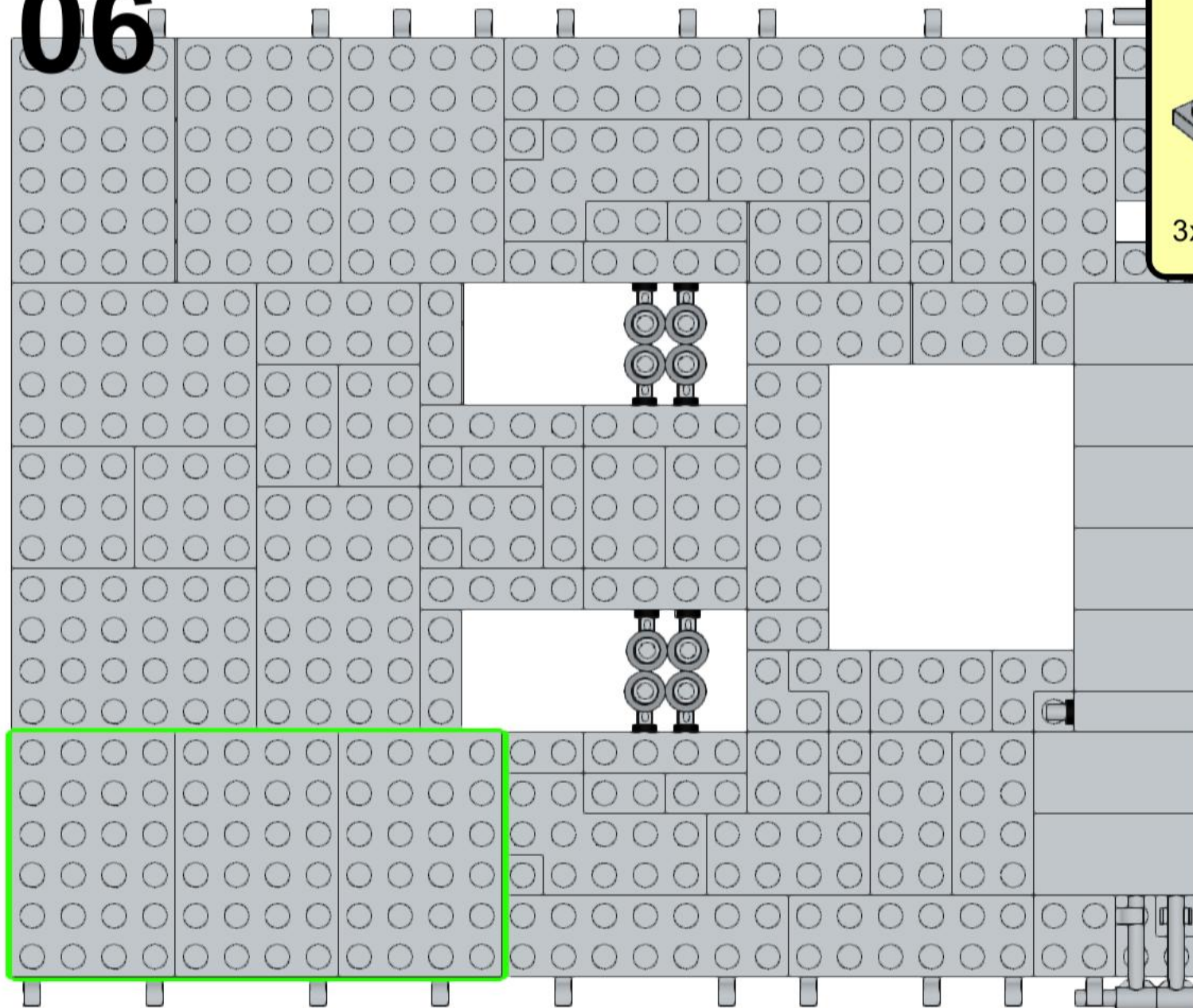

107

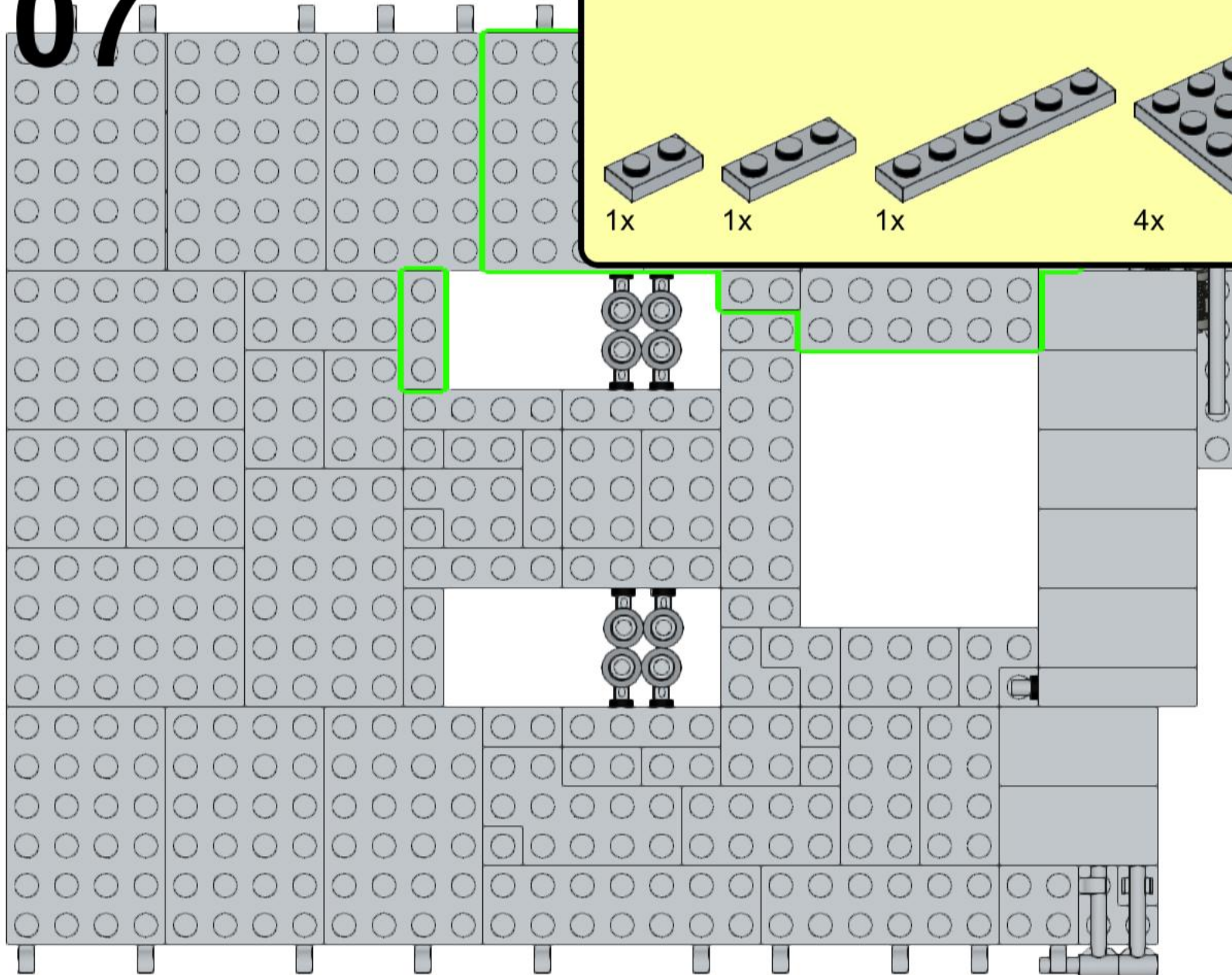
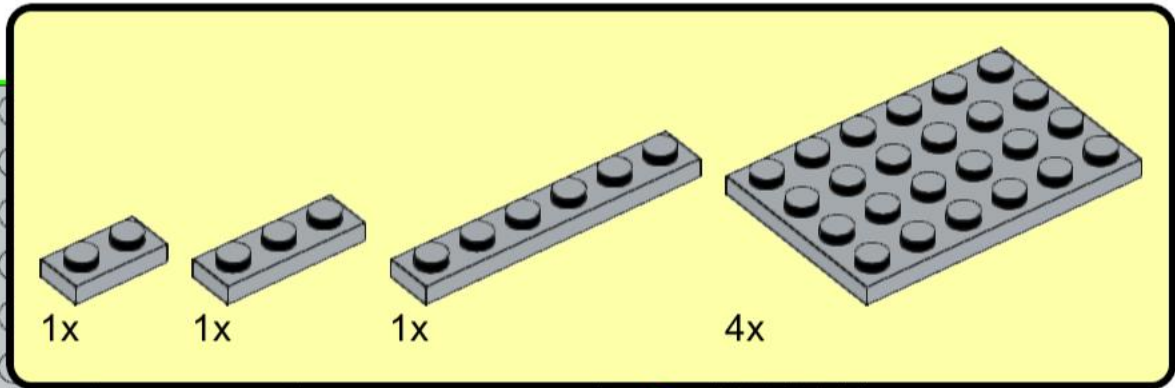

108

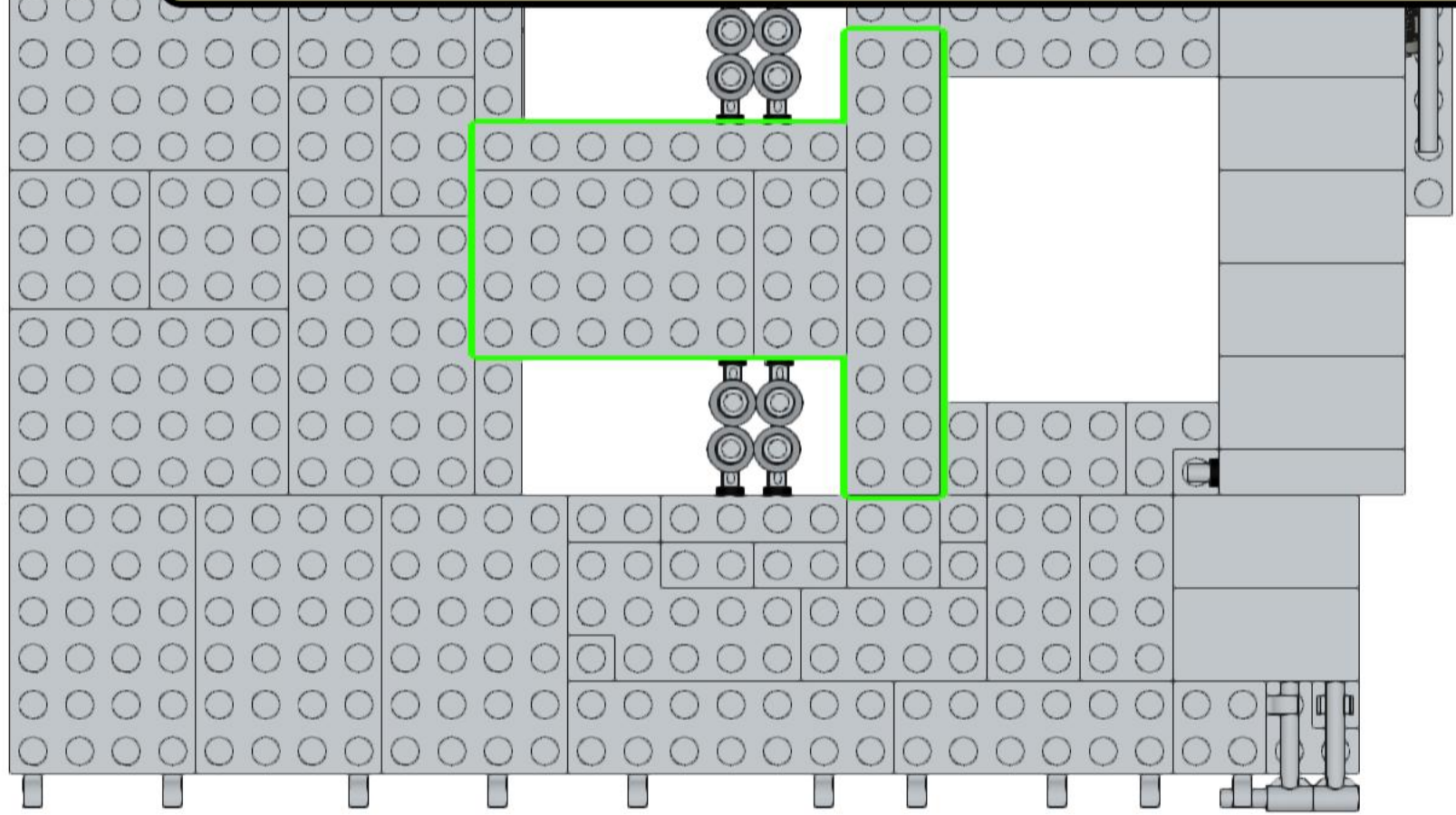
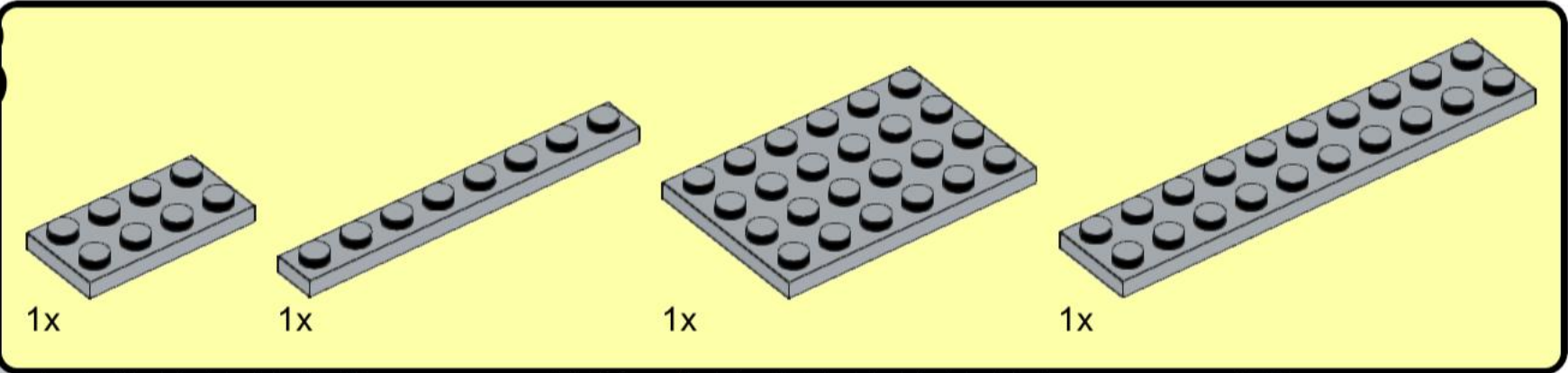

109

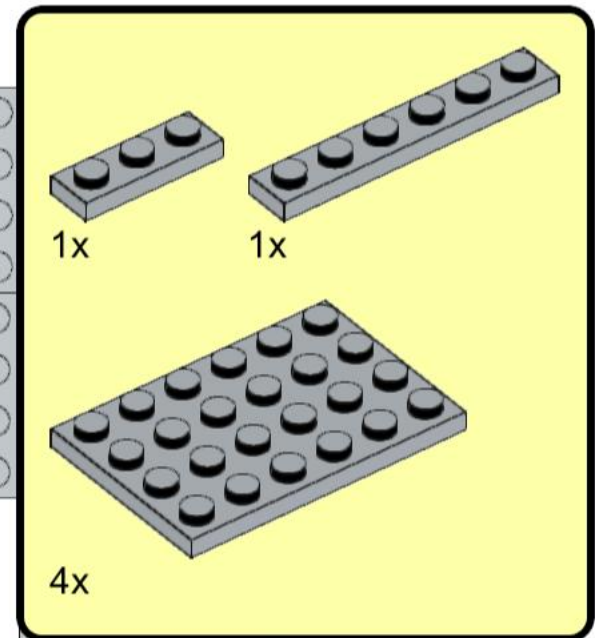
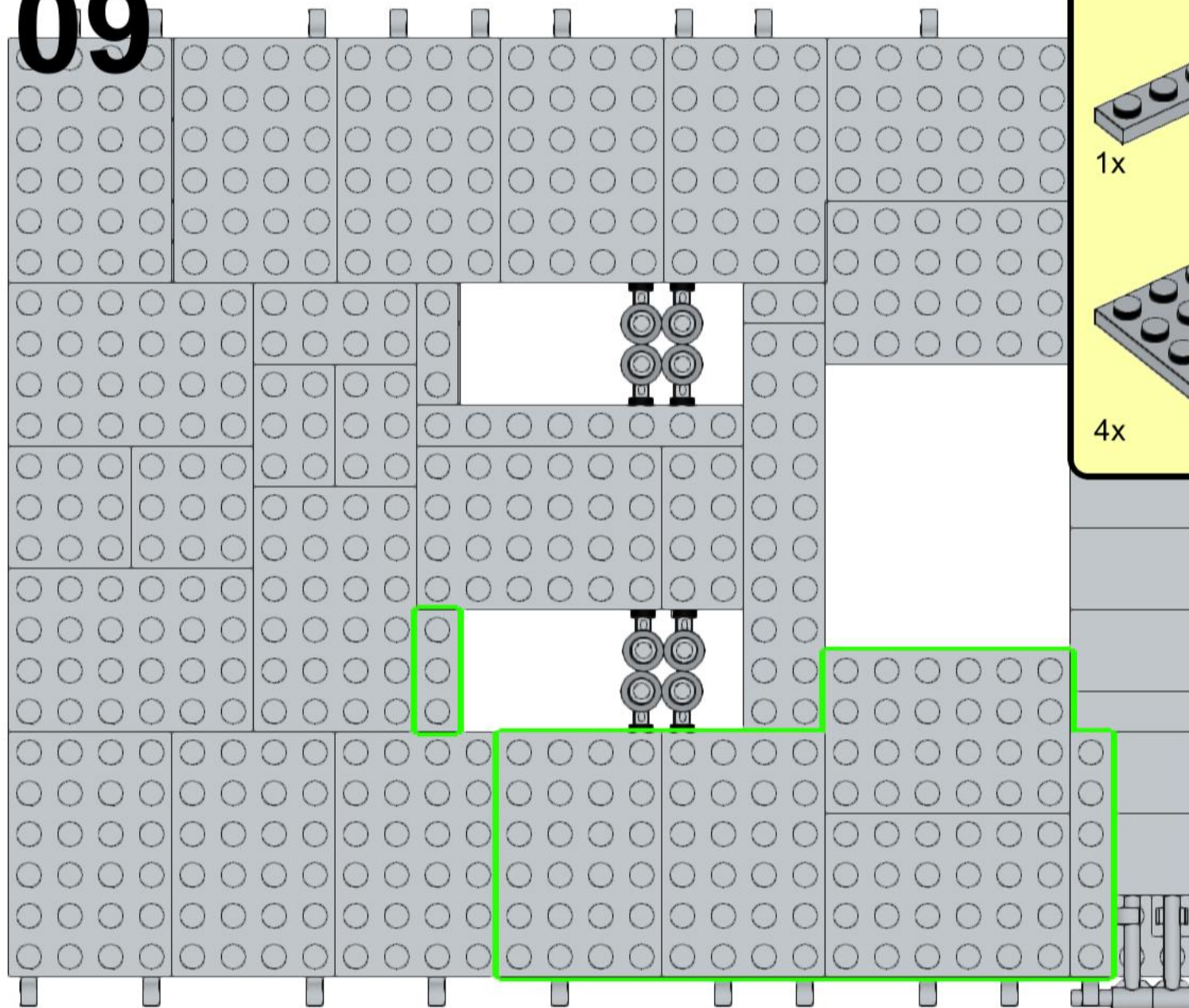

110

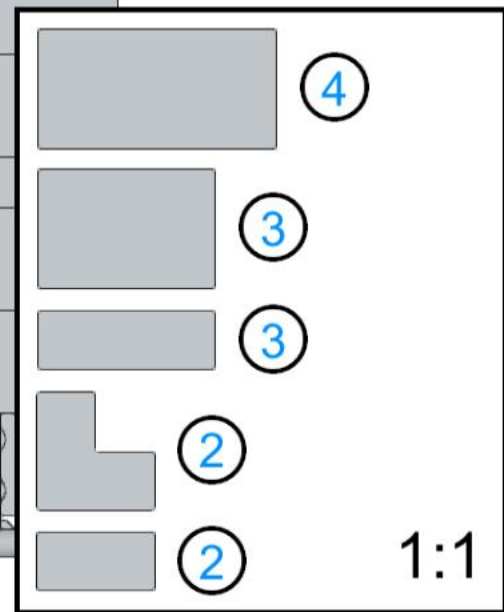
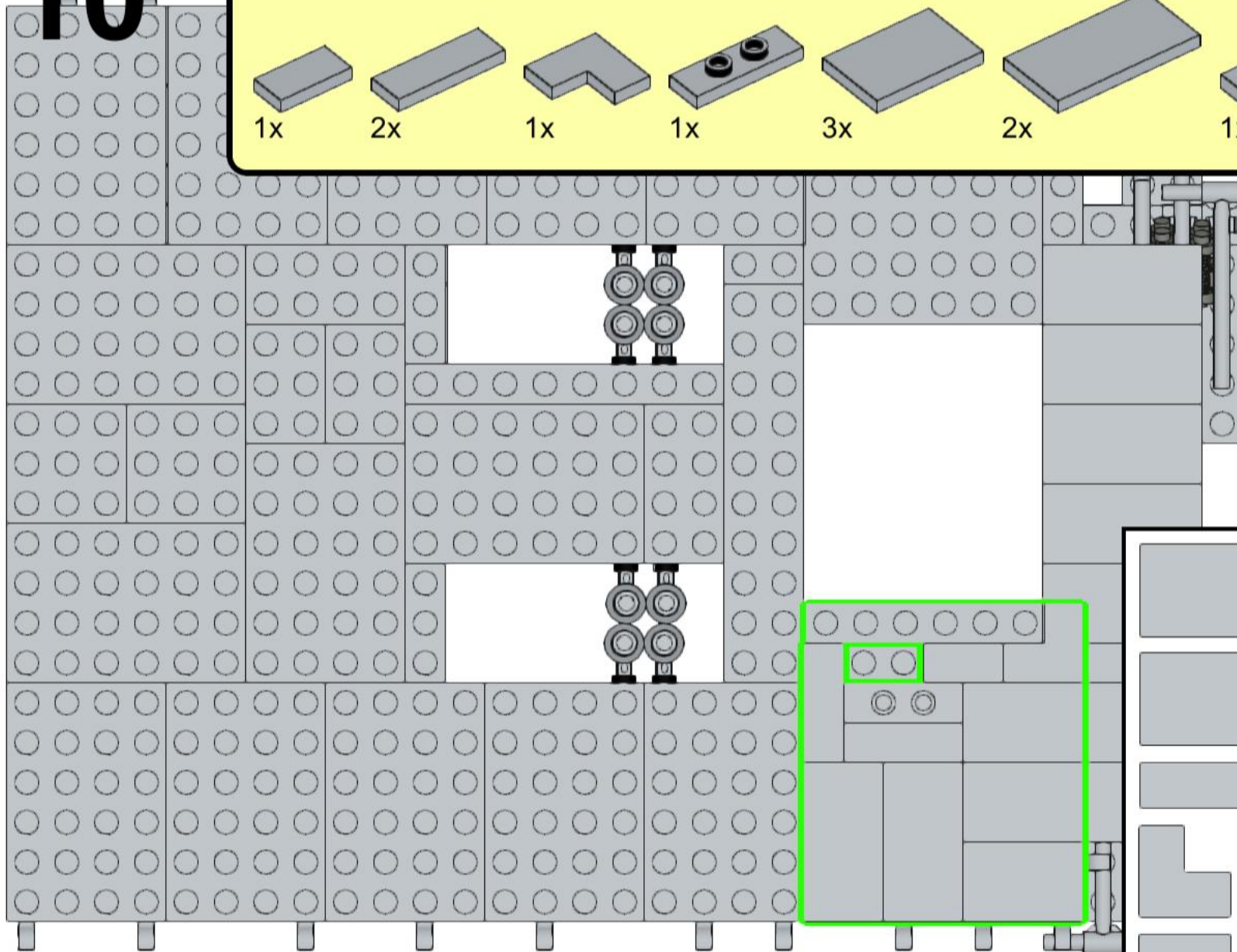
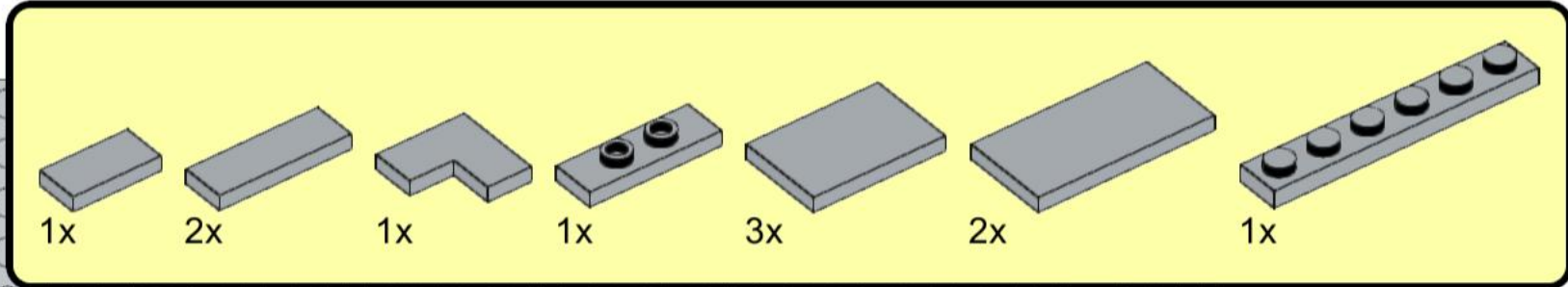

111

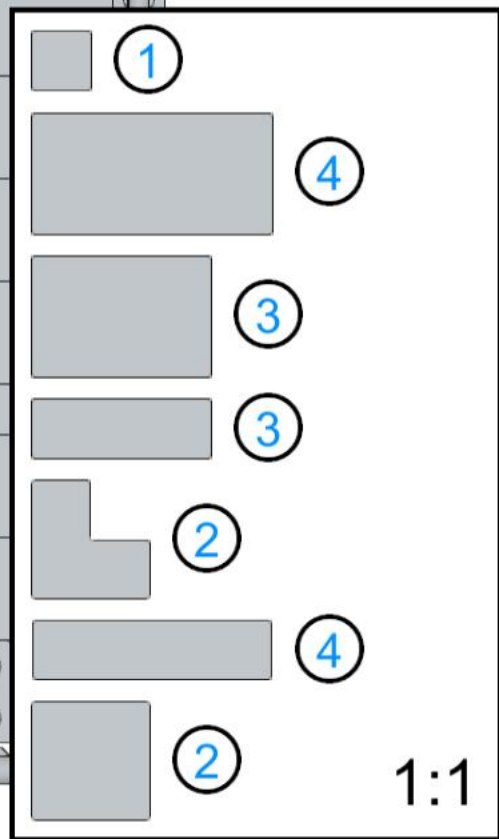
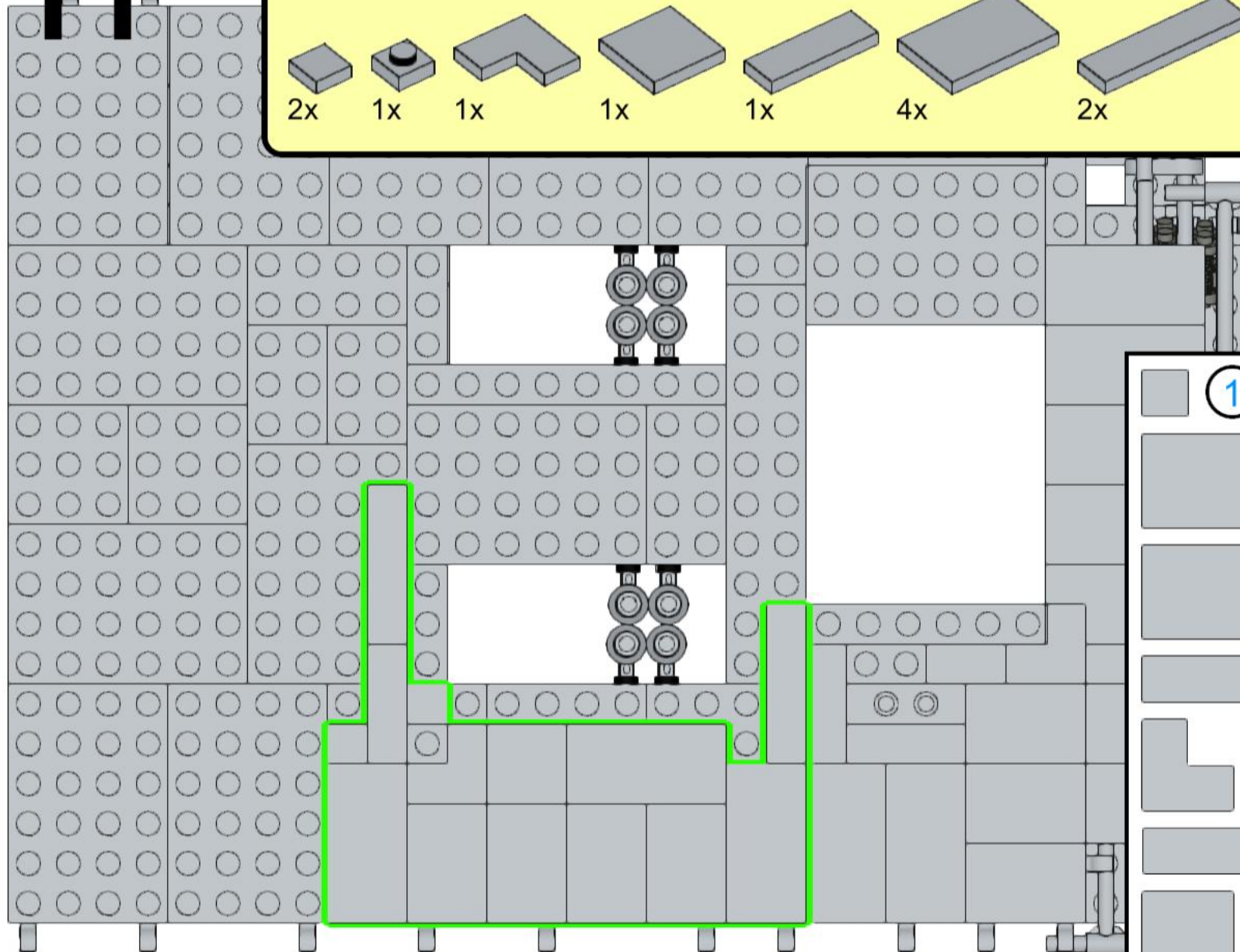
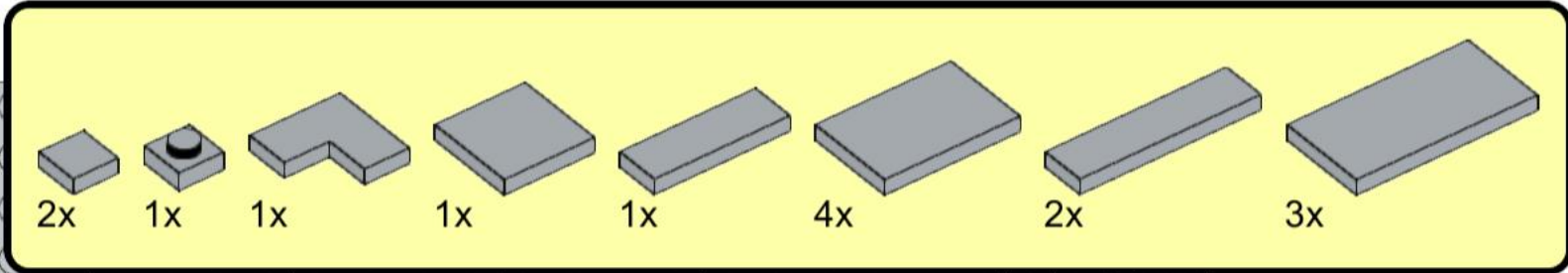

1 12

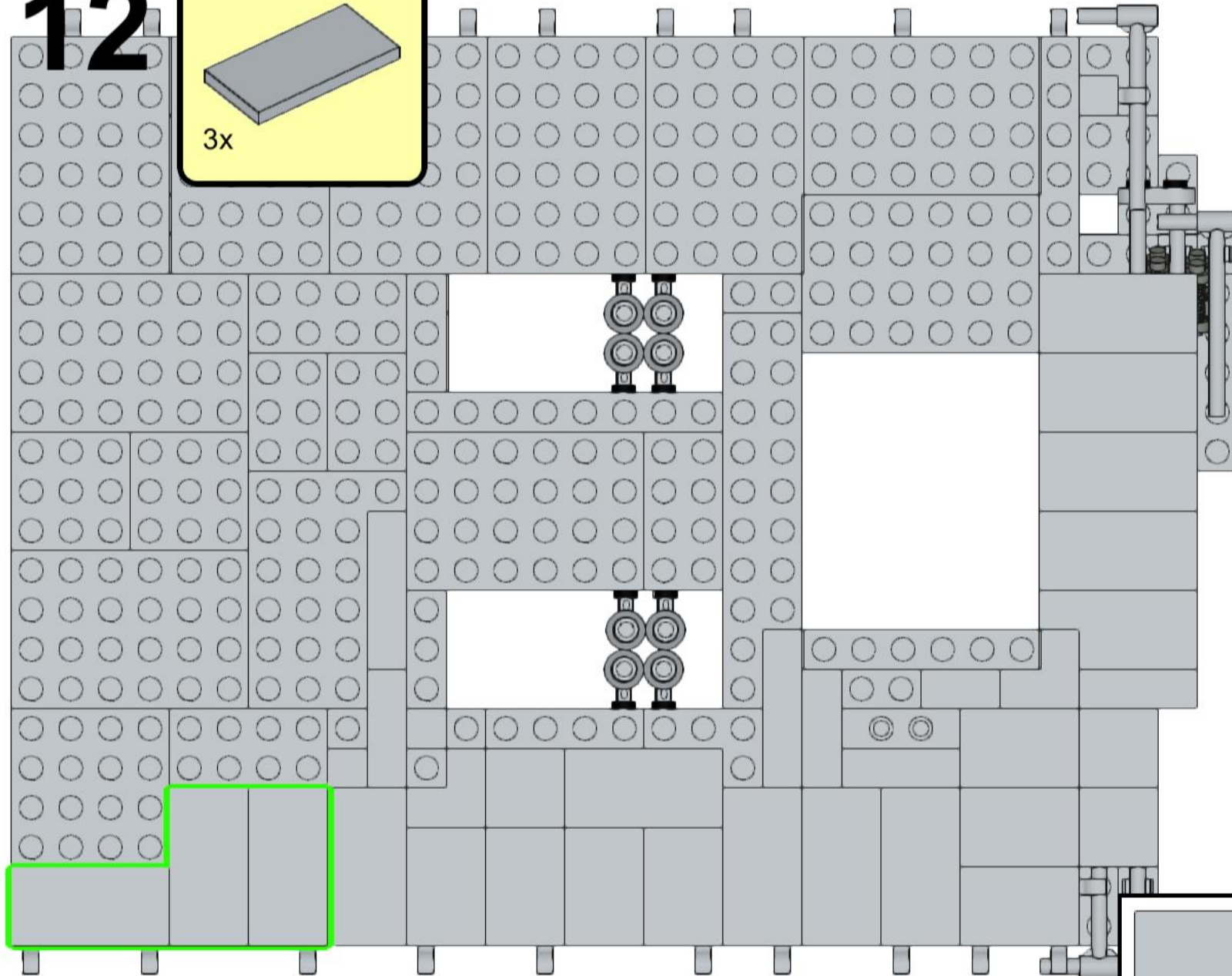
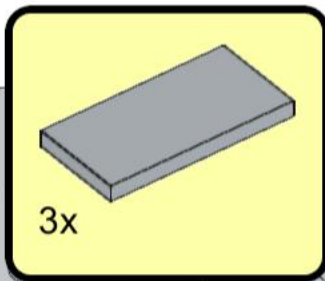

114

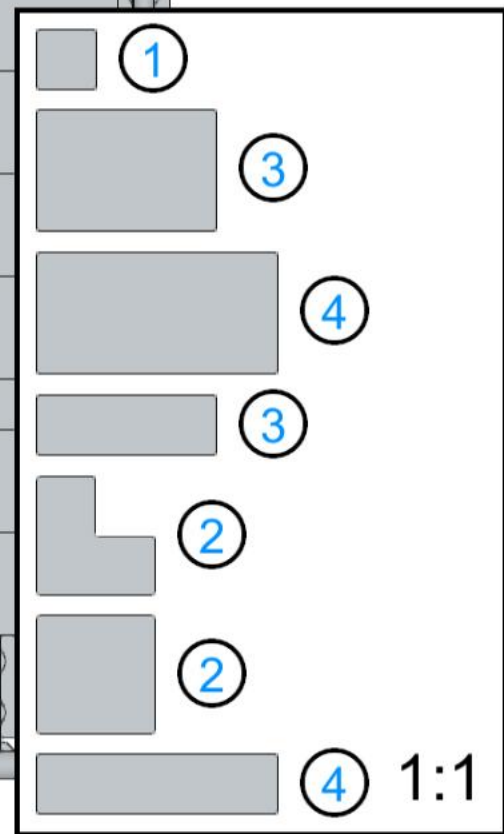
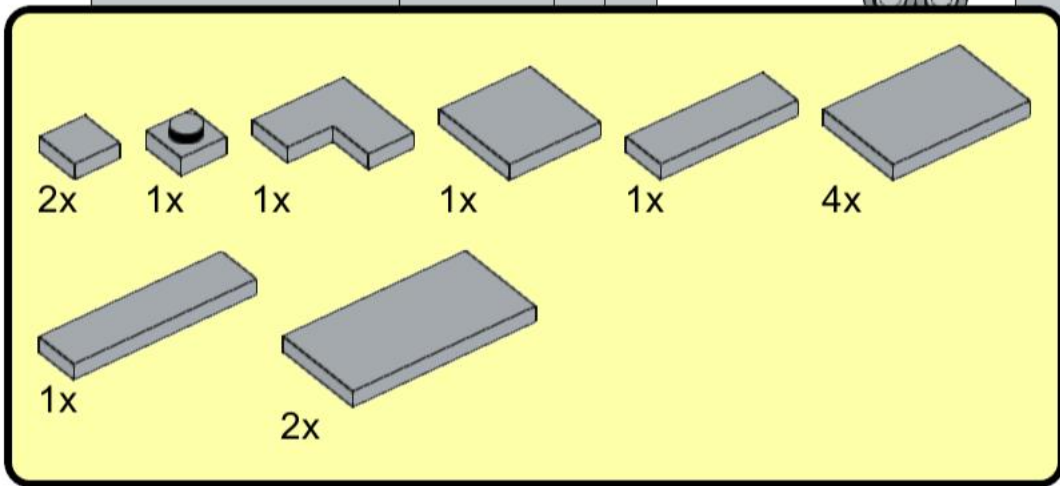
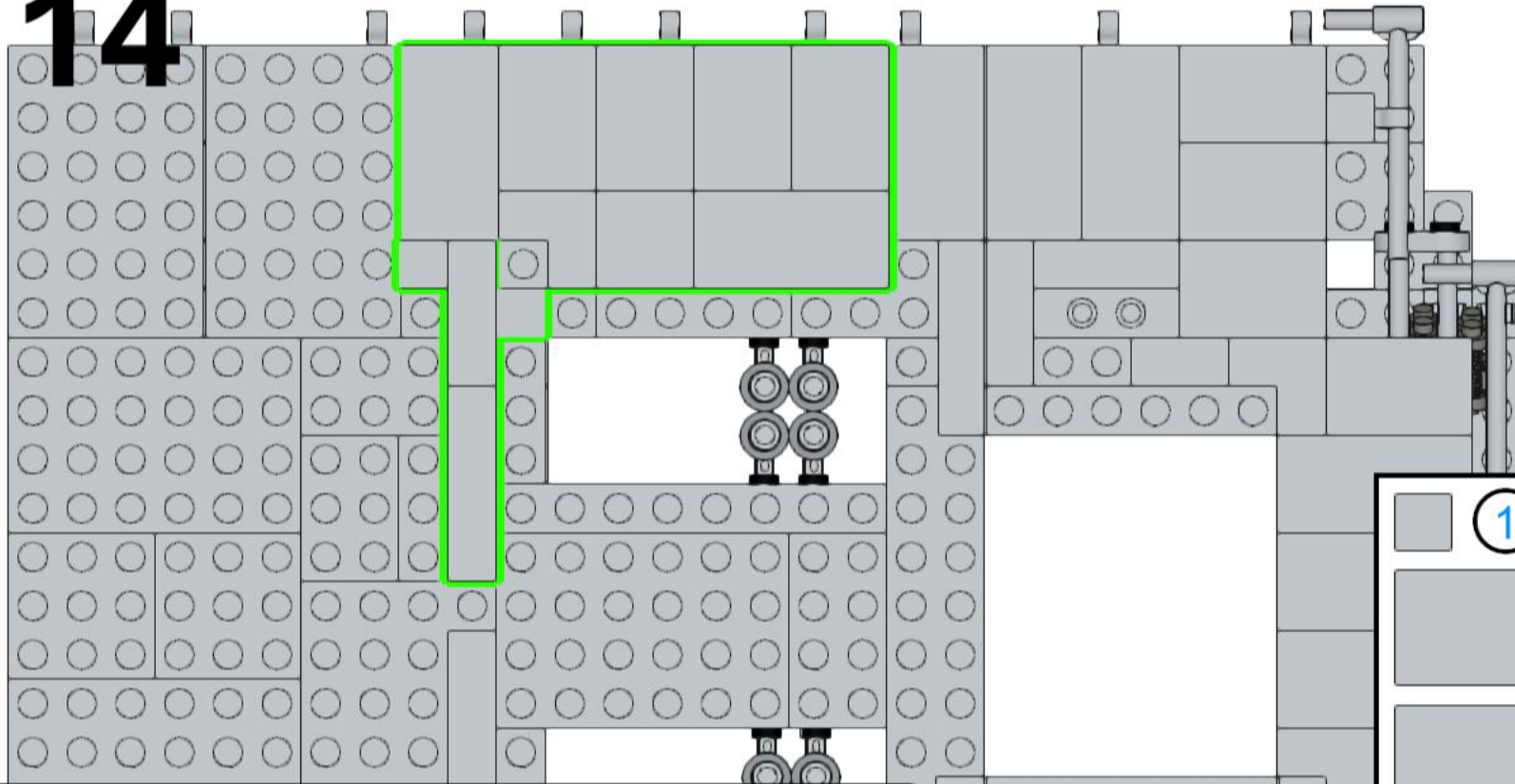

115

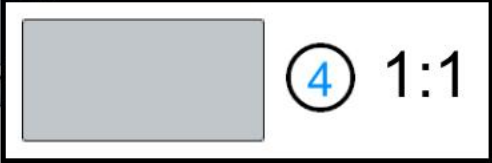
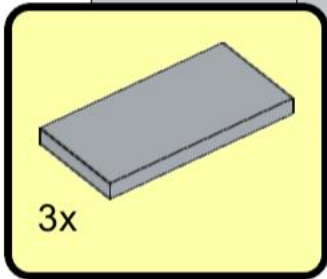
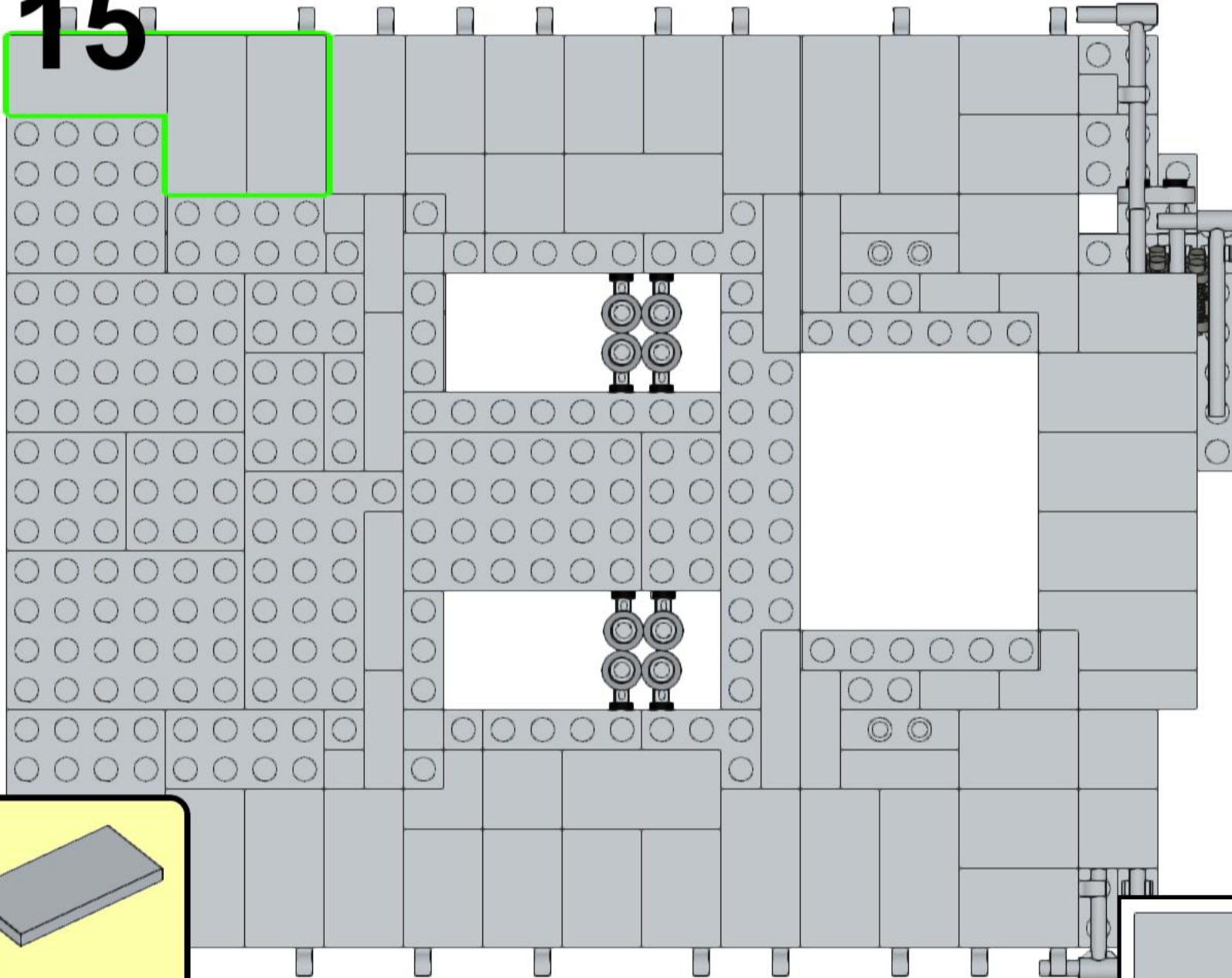

116

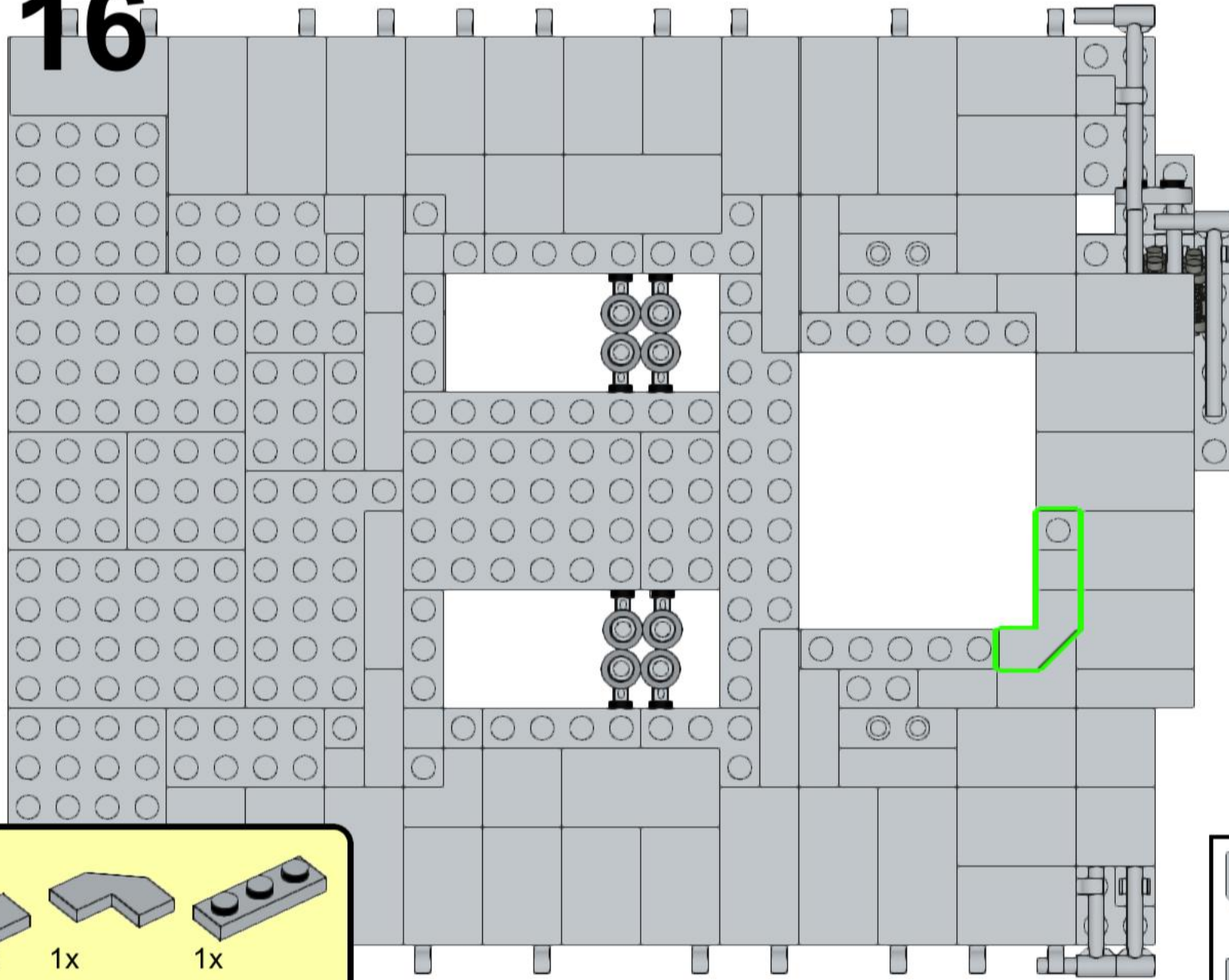

1x 1x 1x

2 1 1:1

117

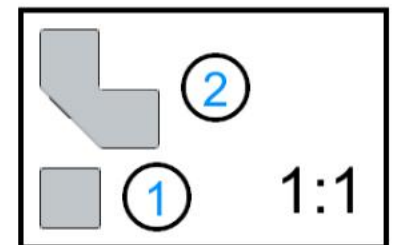
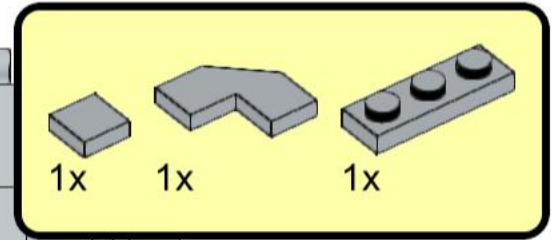
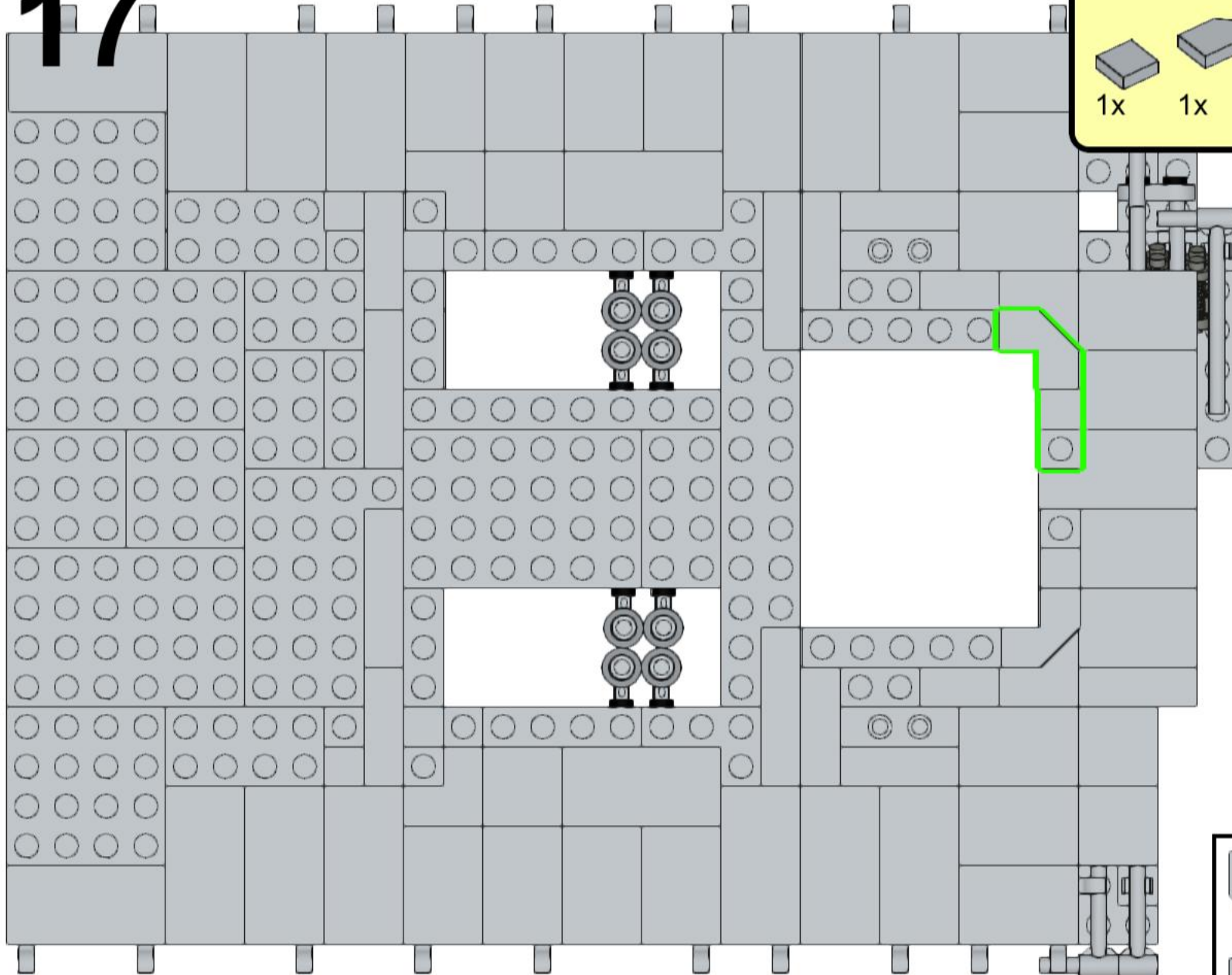

118

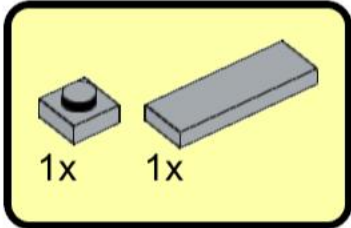
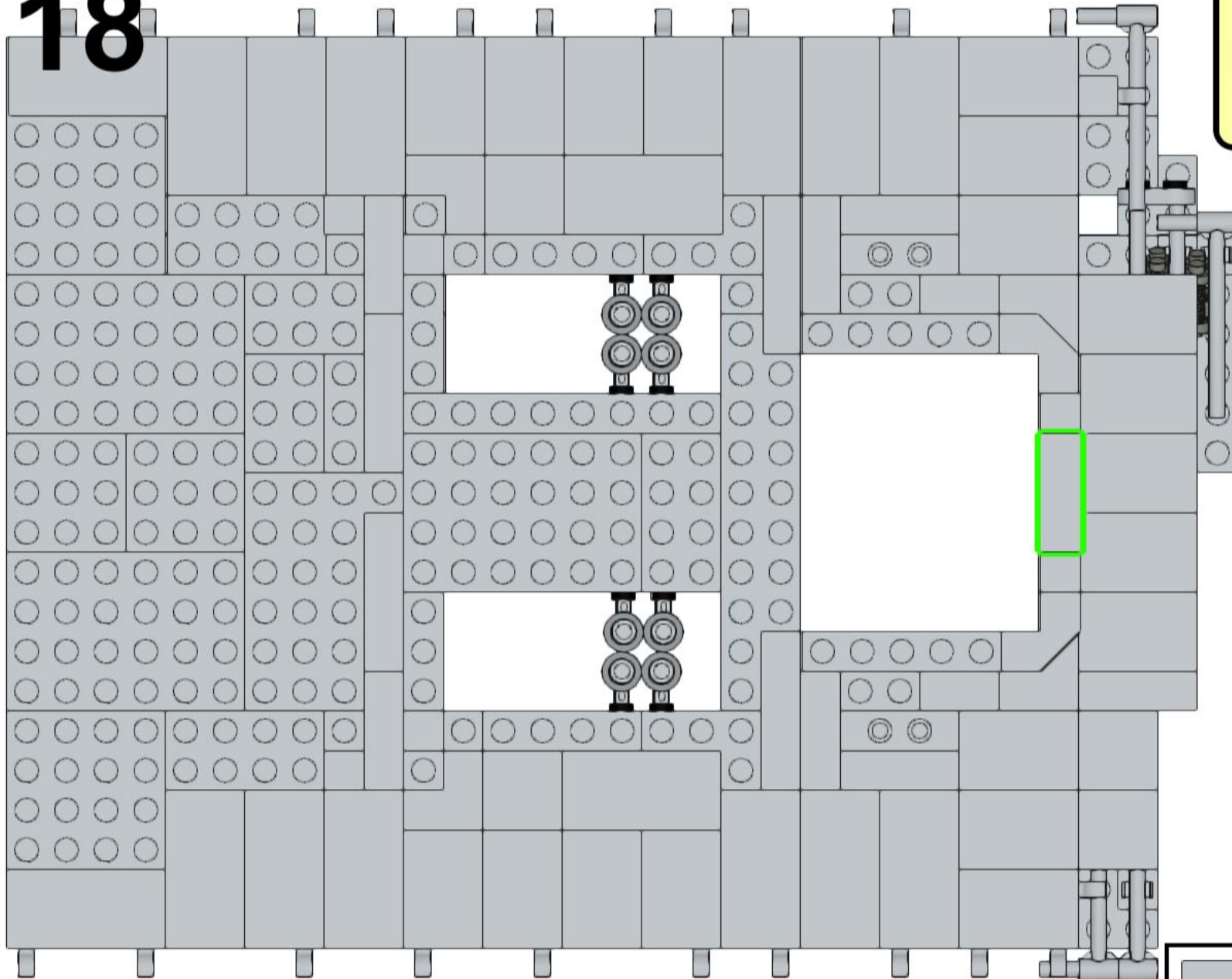

119

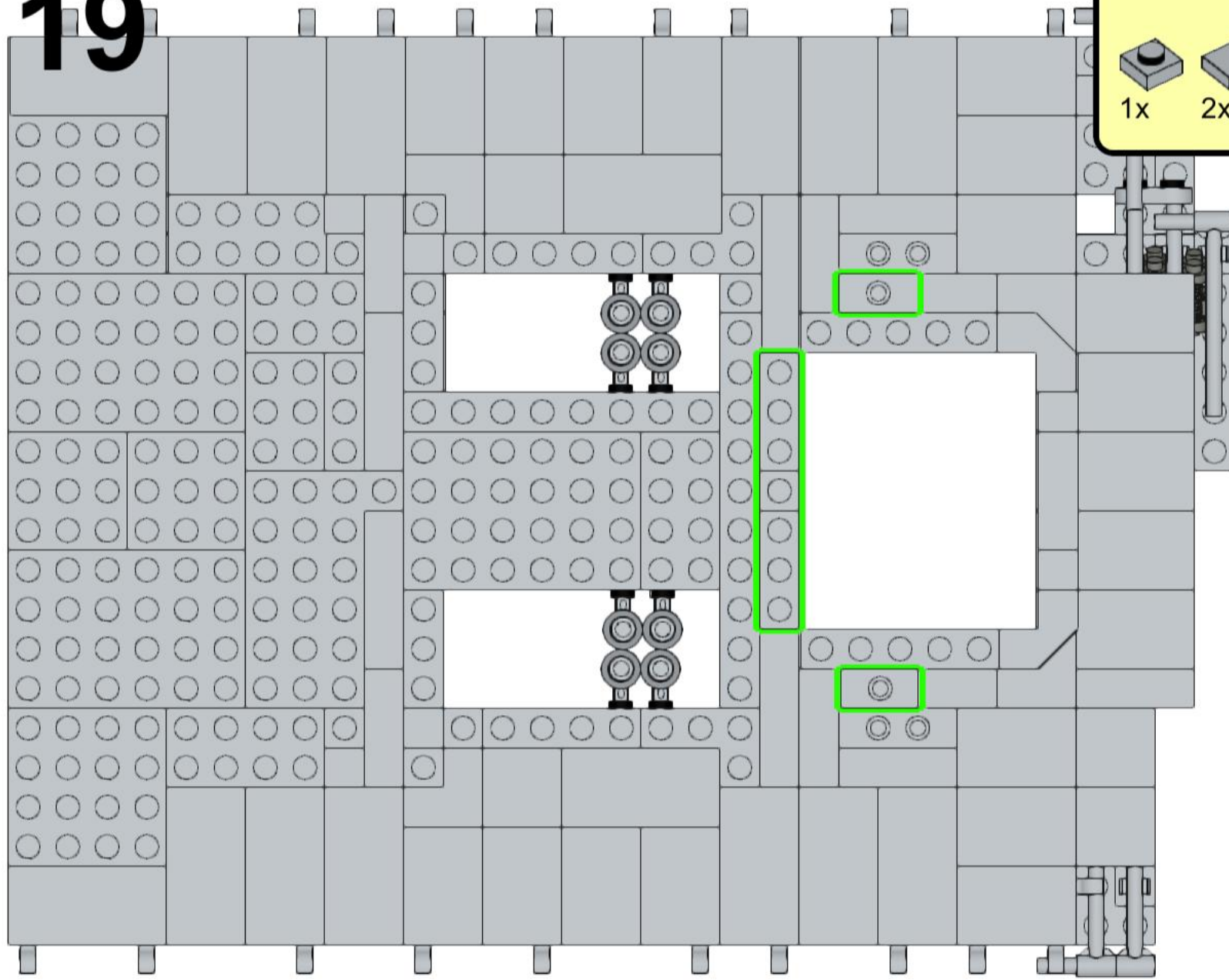

1x 2x 2x

120

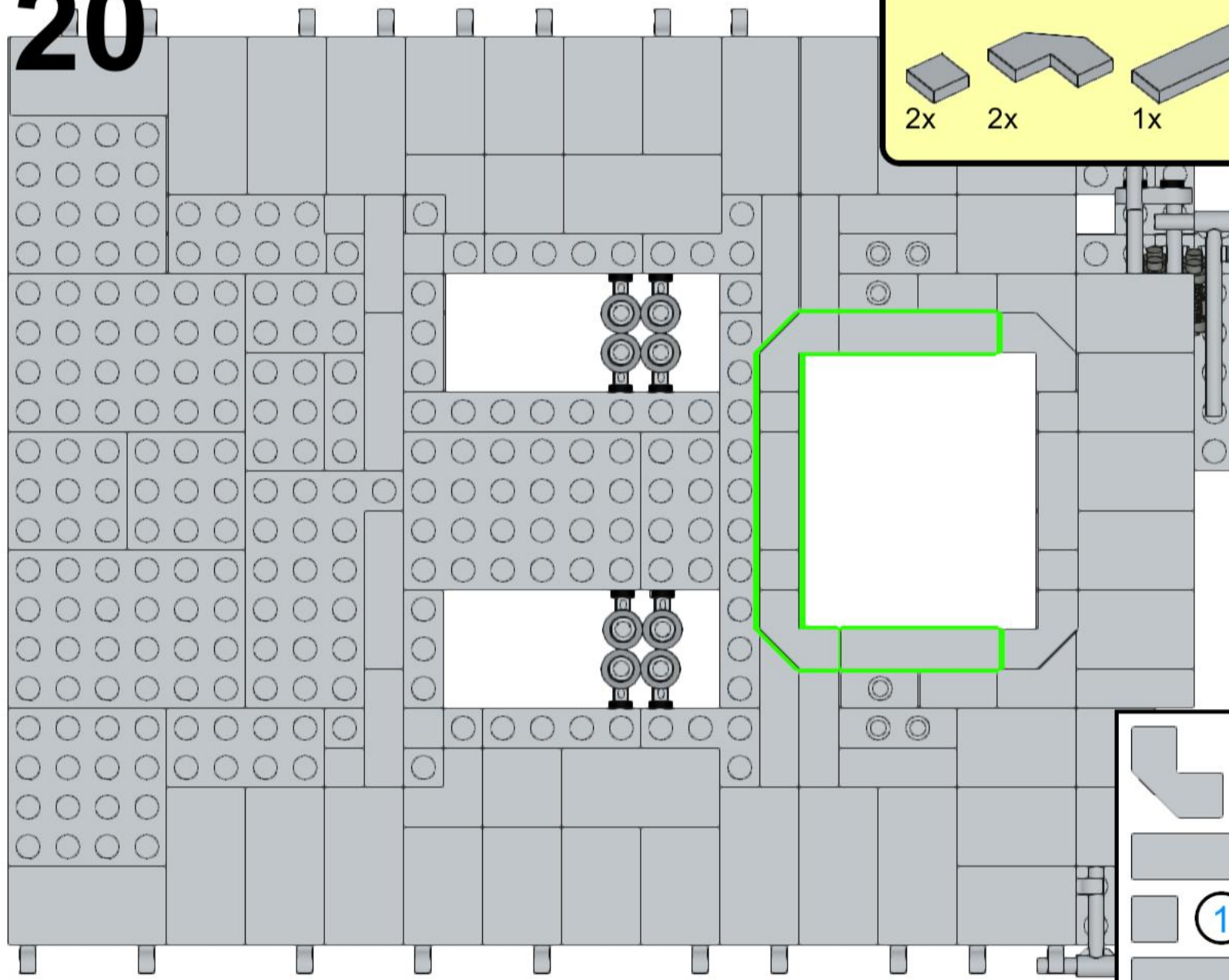

2x 2x 1x 2x

2 3 1 4 1:1

121

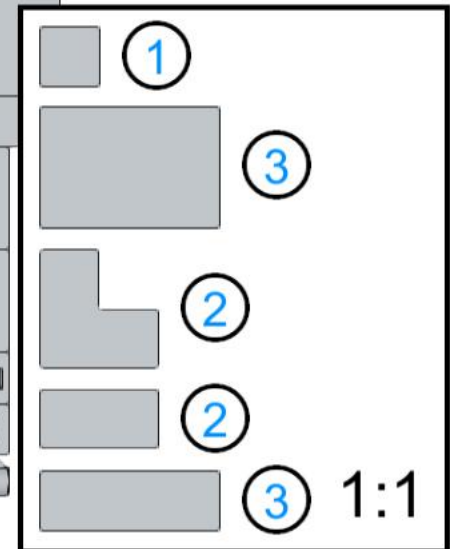
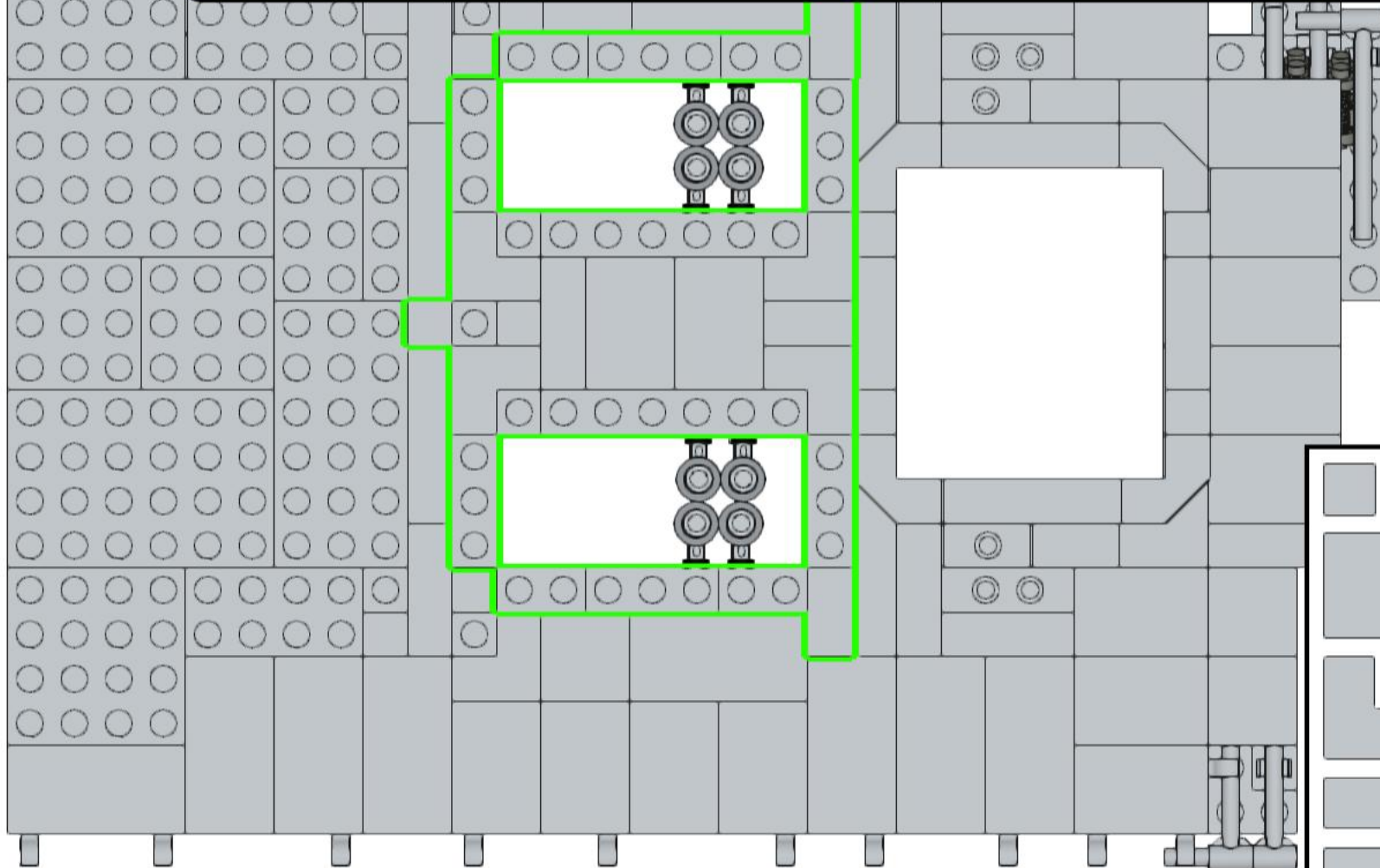
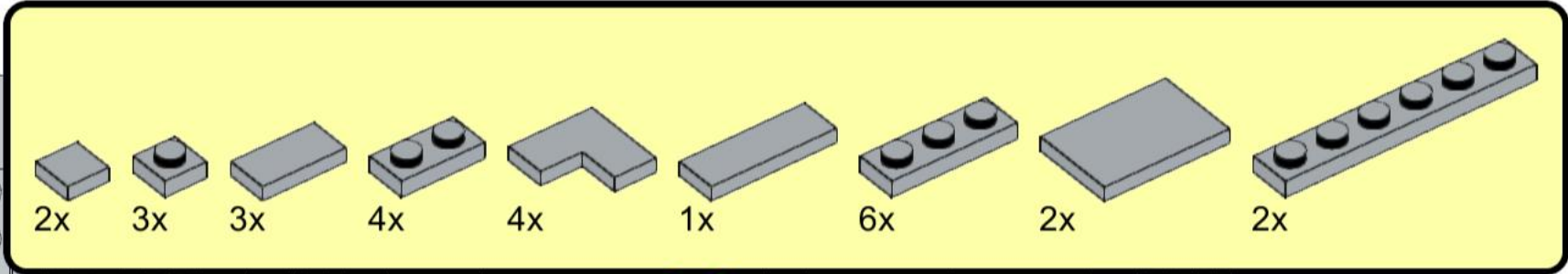

122

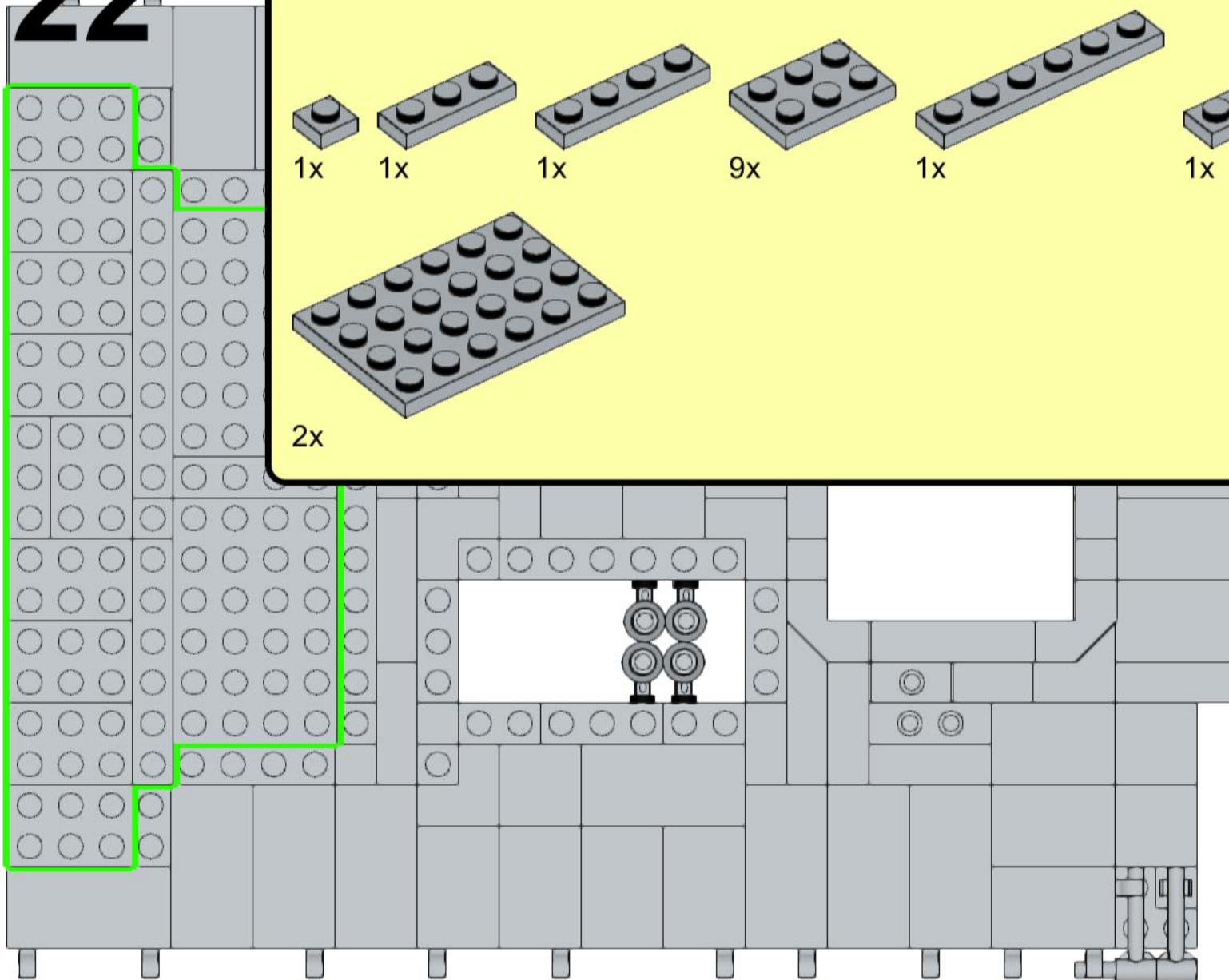
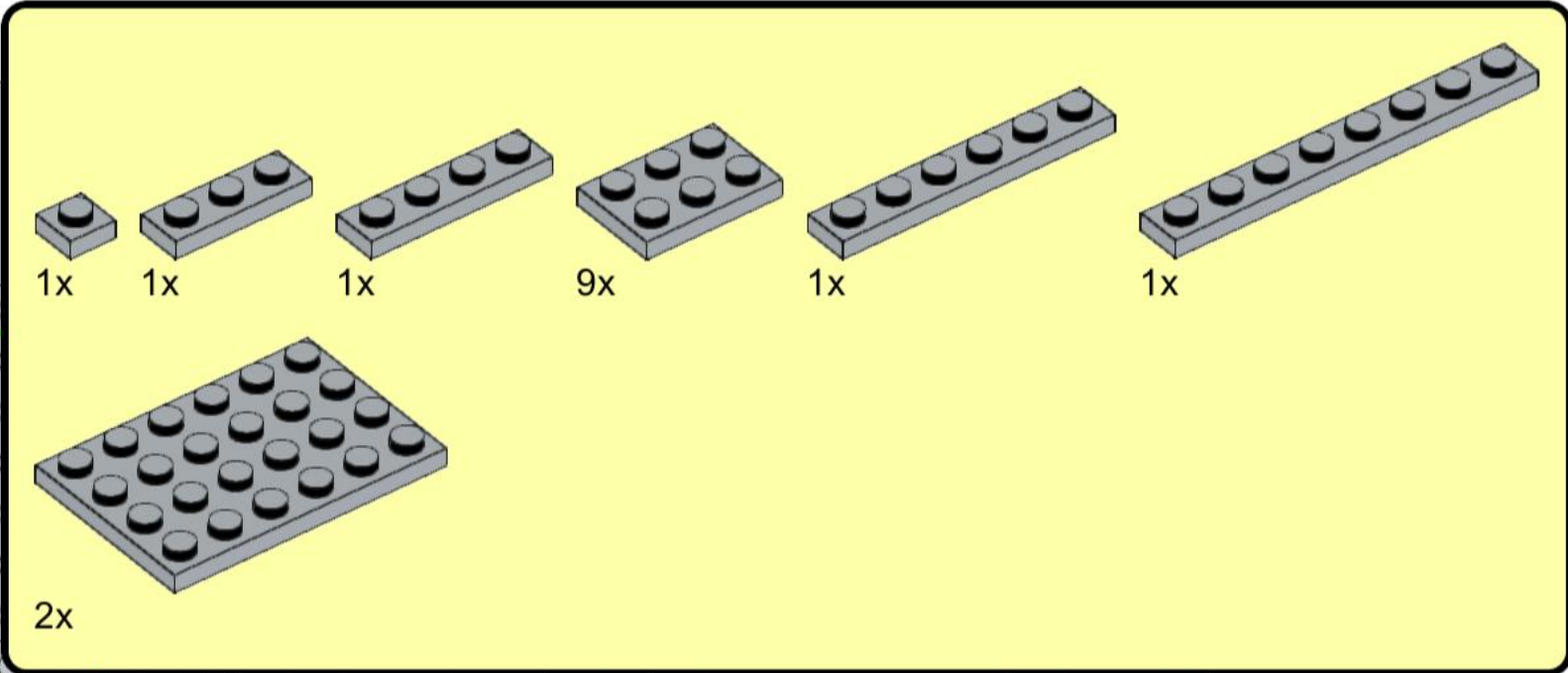

123

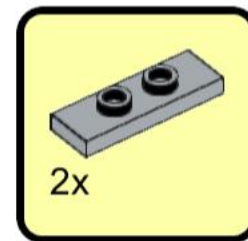
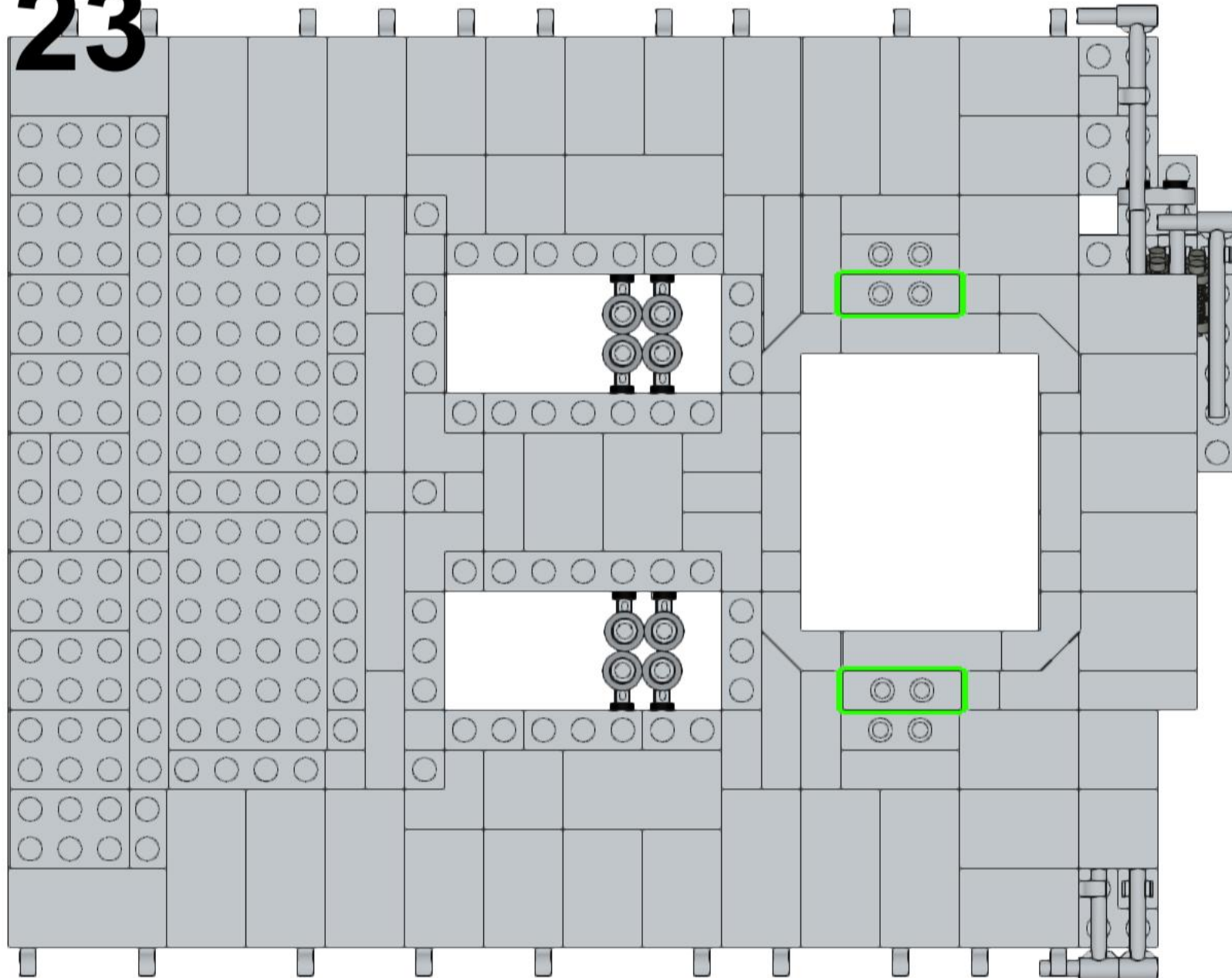

124

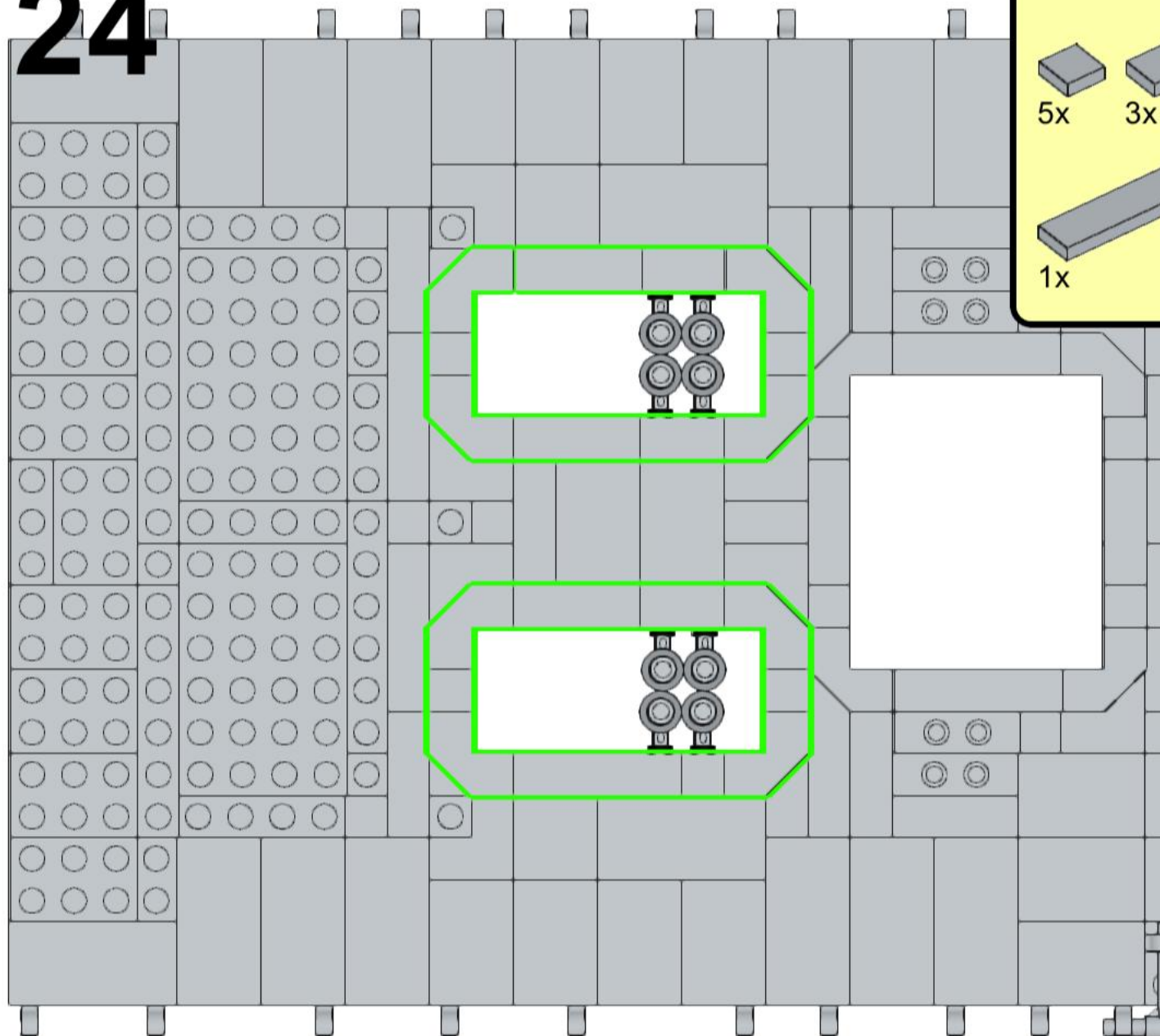

5x
3x
3x
8x
1x

2
1
3
2
4 1:1

125

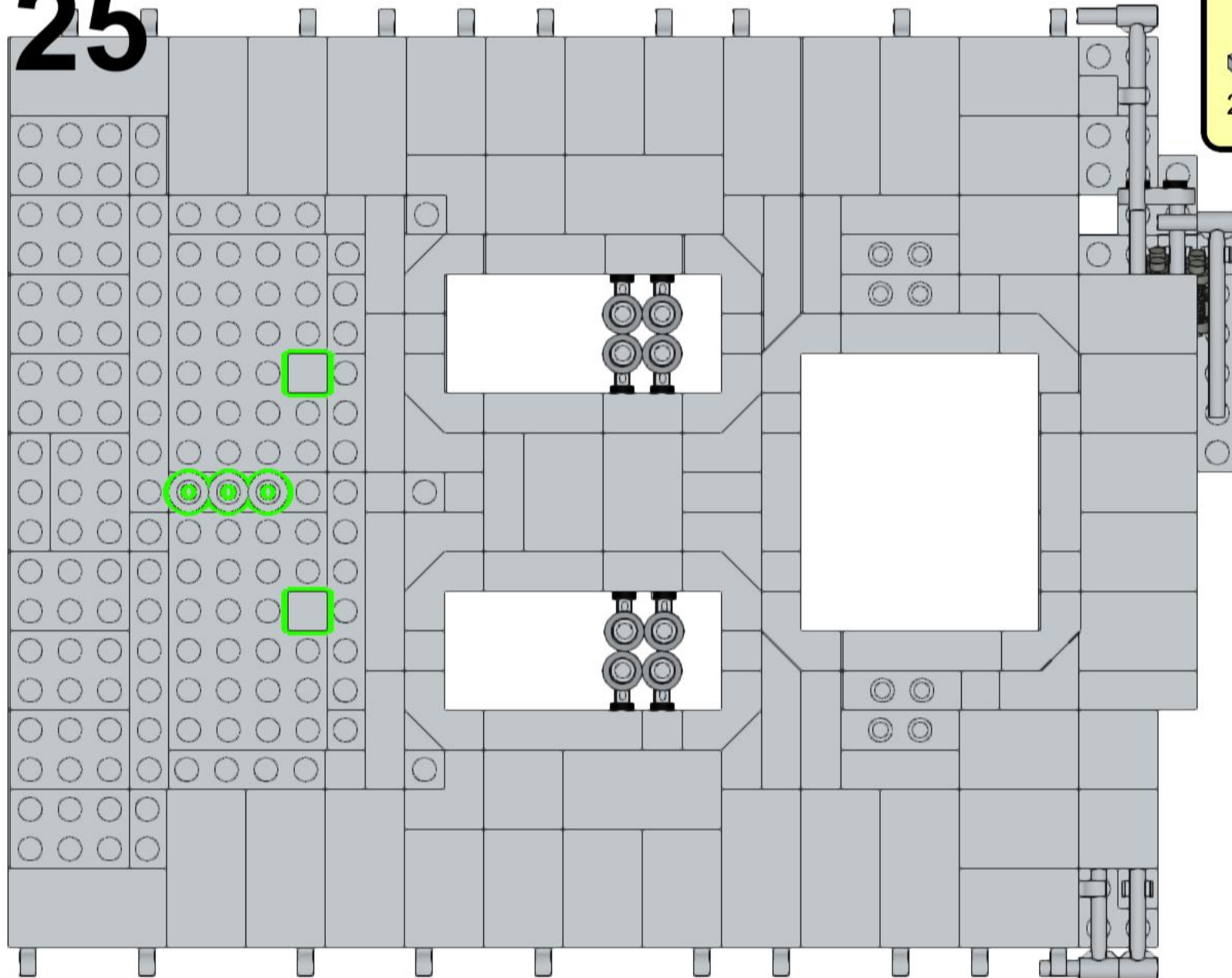
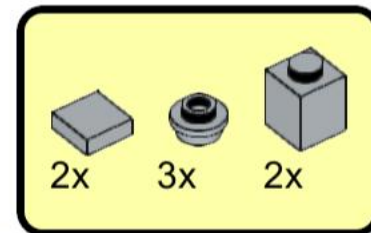

126

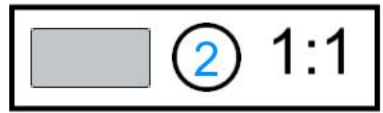
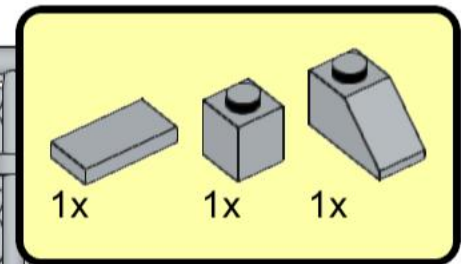
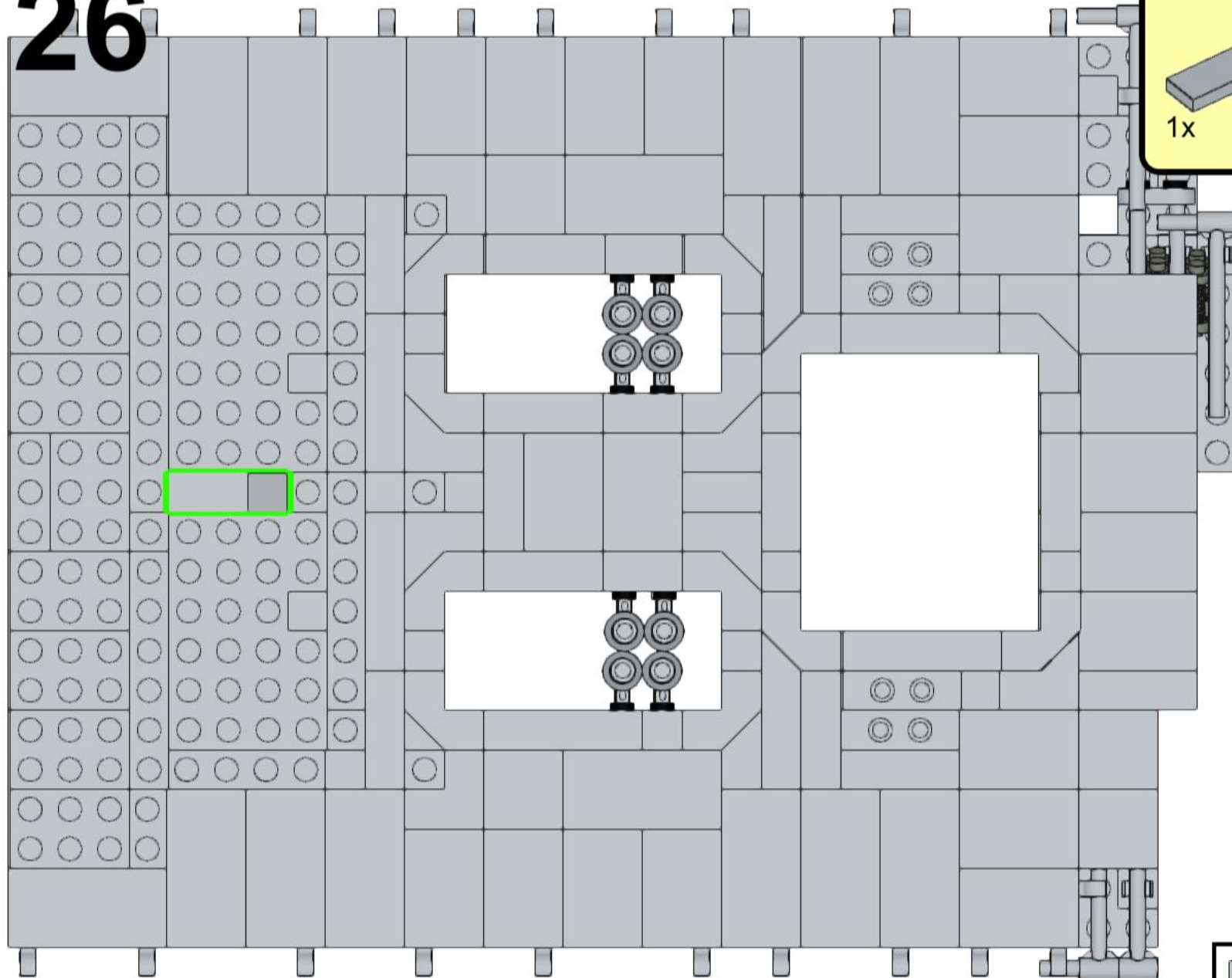

127

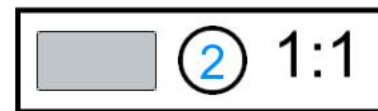
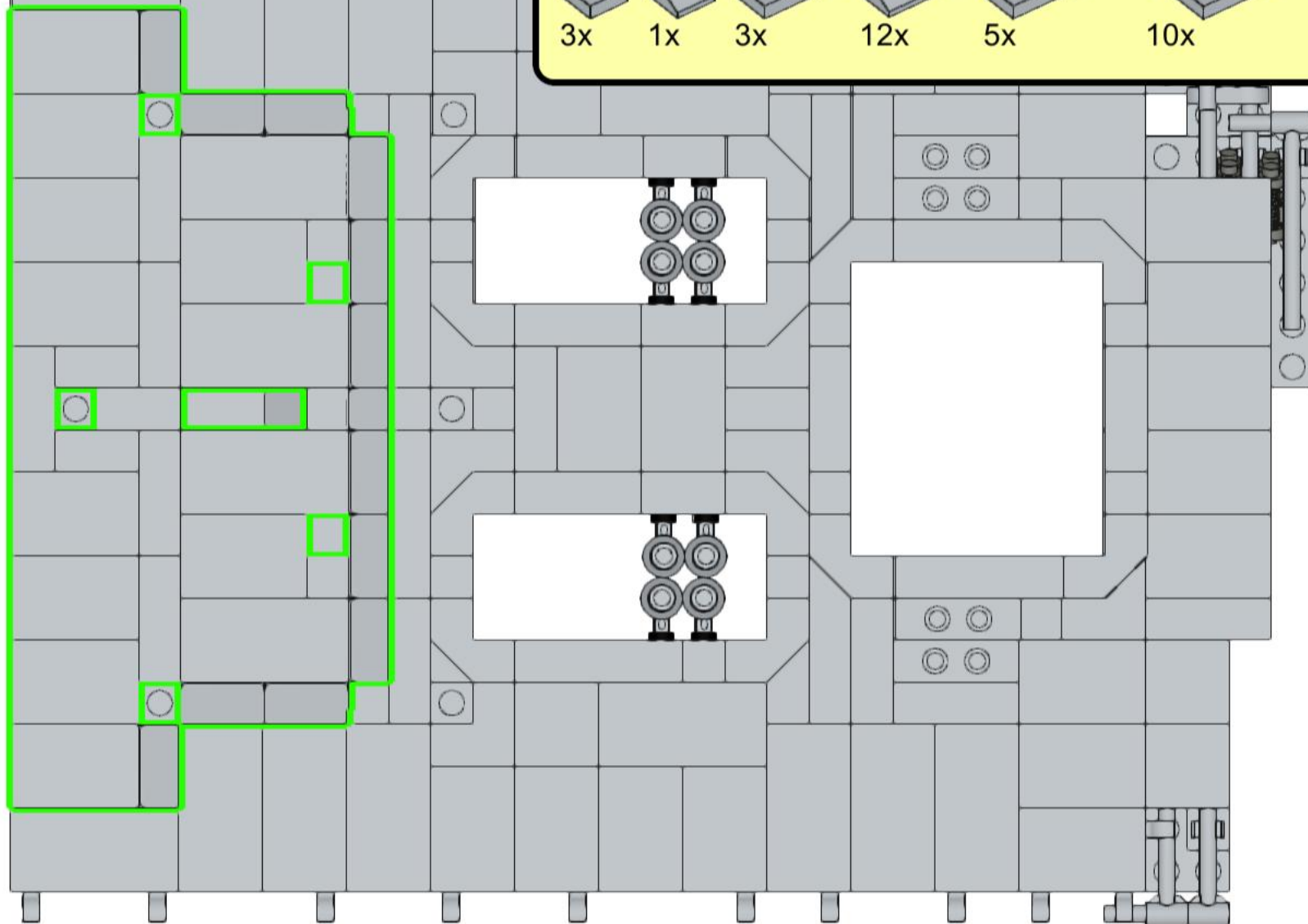
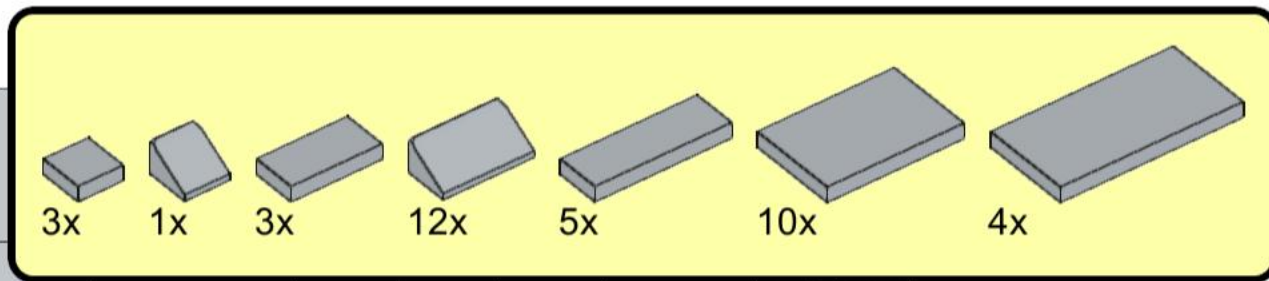

128

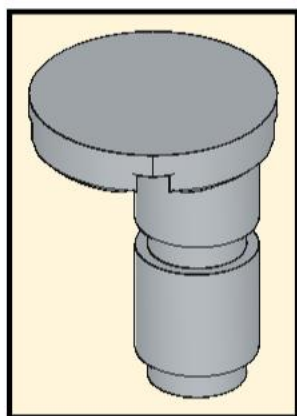
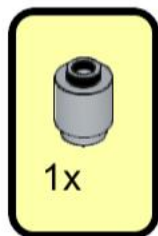

129



130

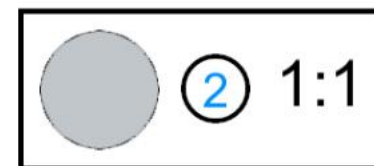
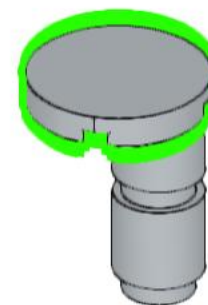
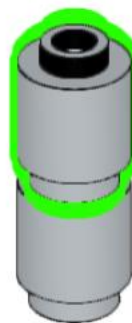
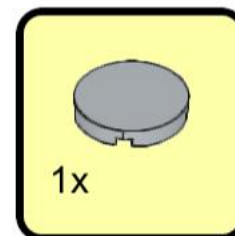

131

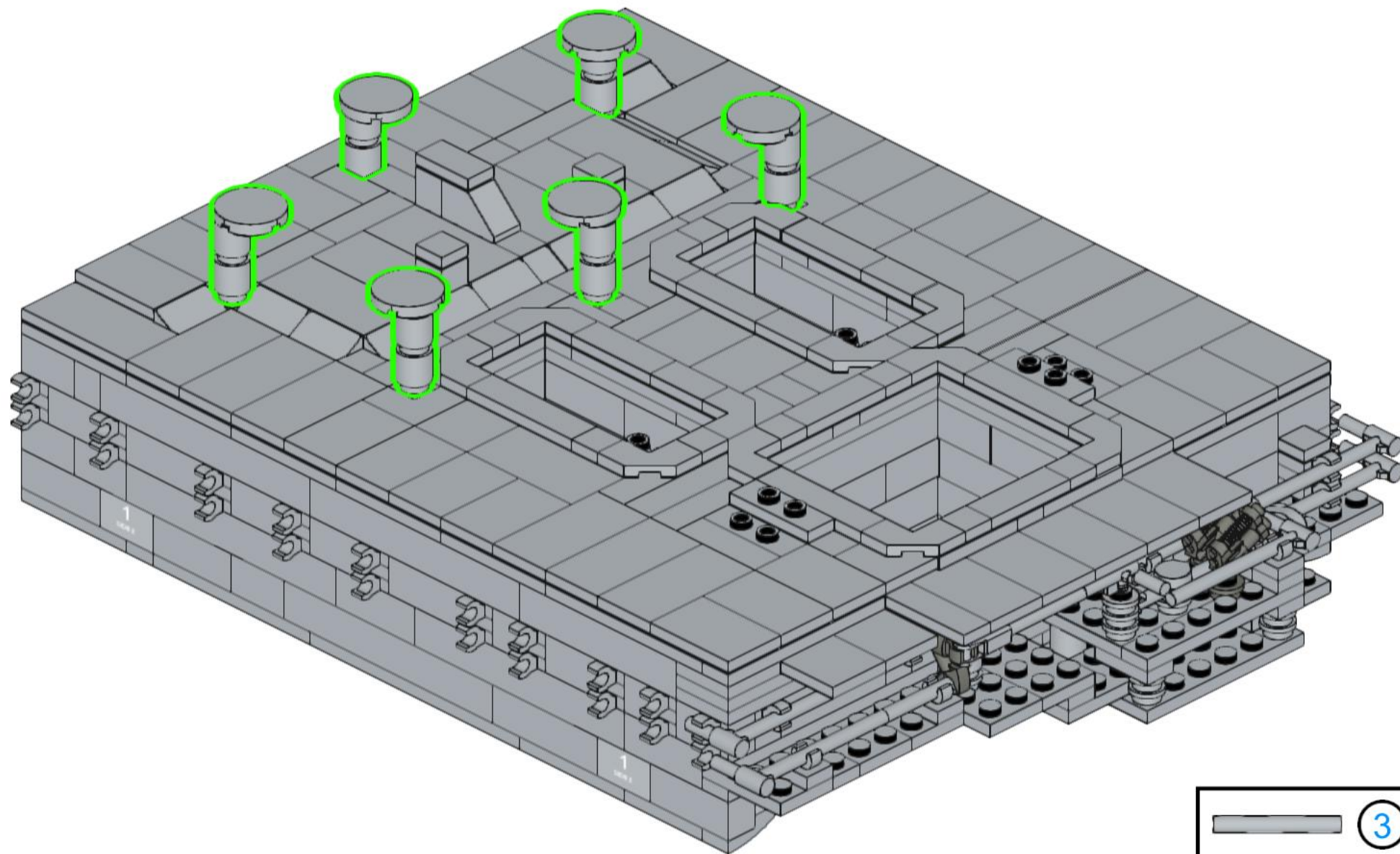

— (3) 1:1

132

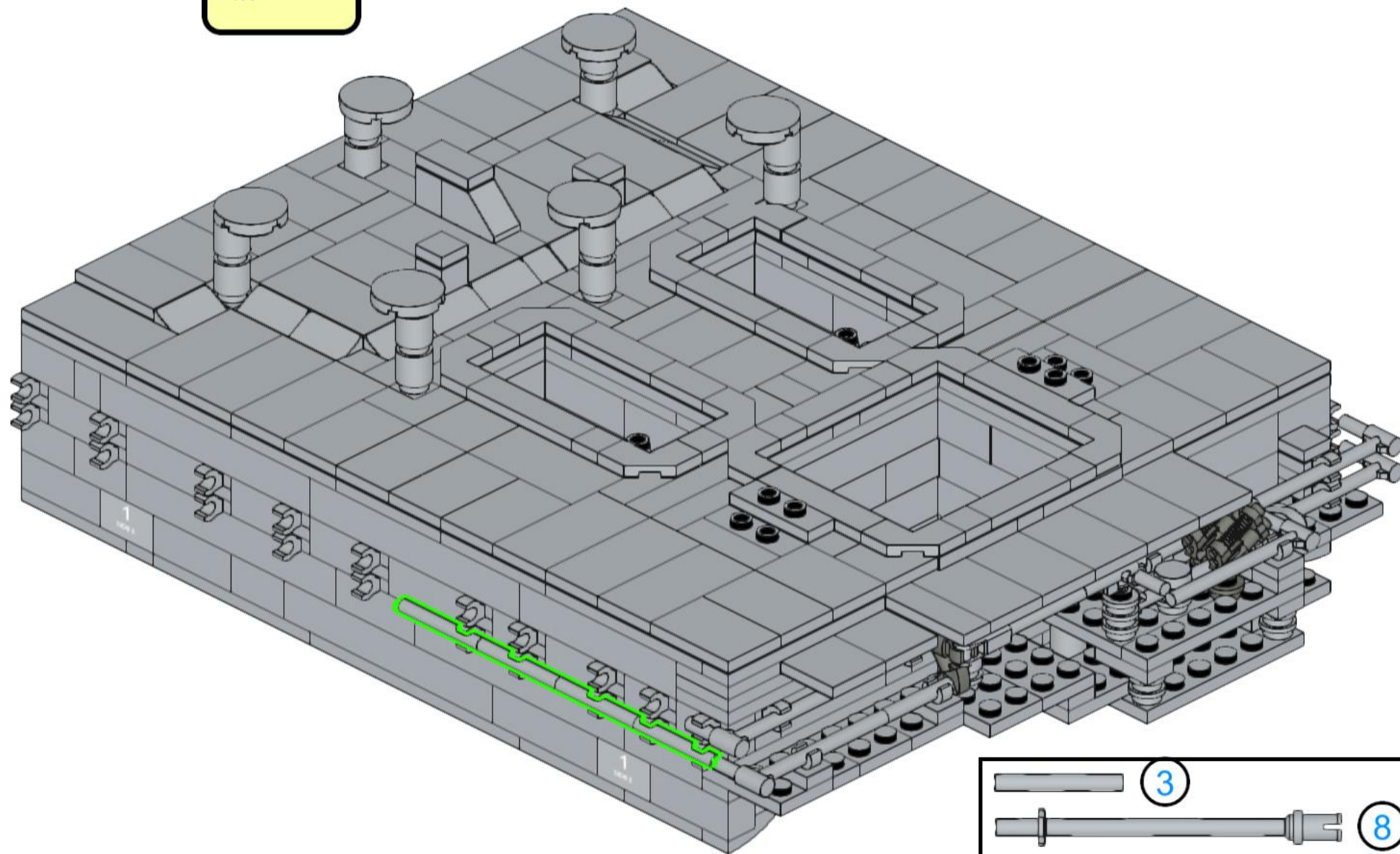
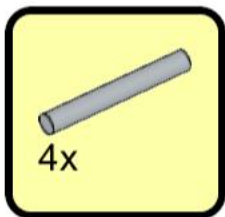

133

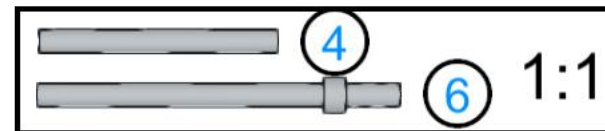
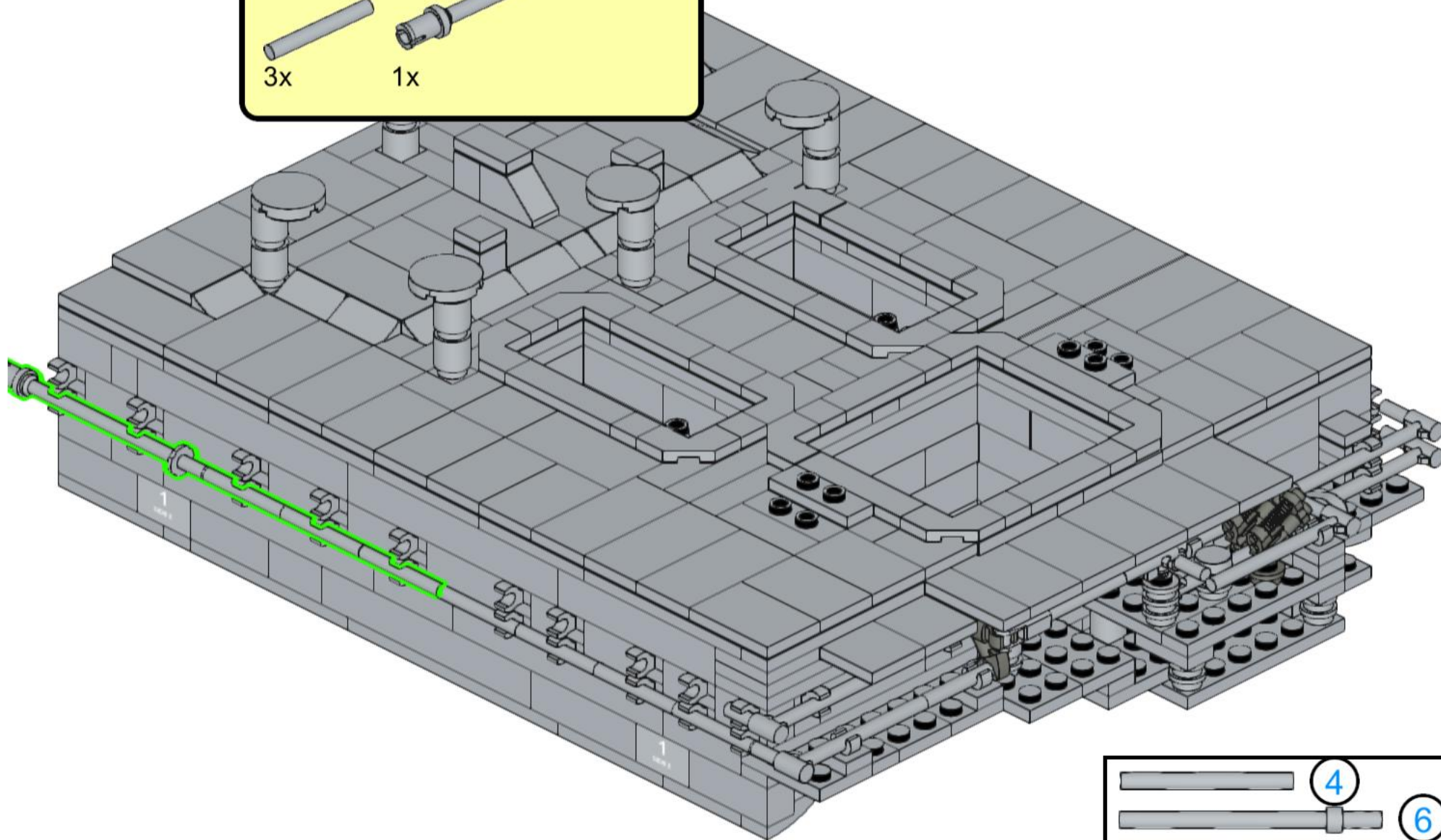
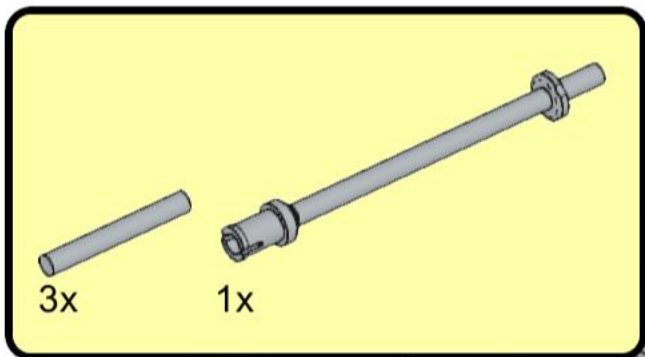

134

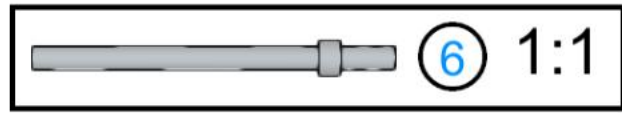
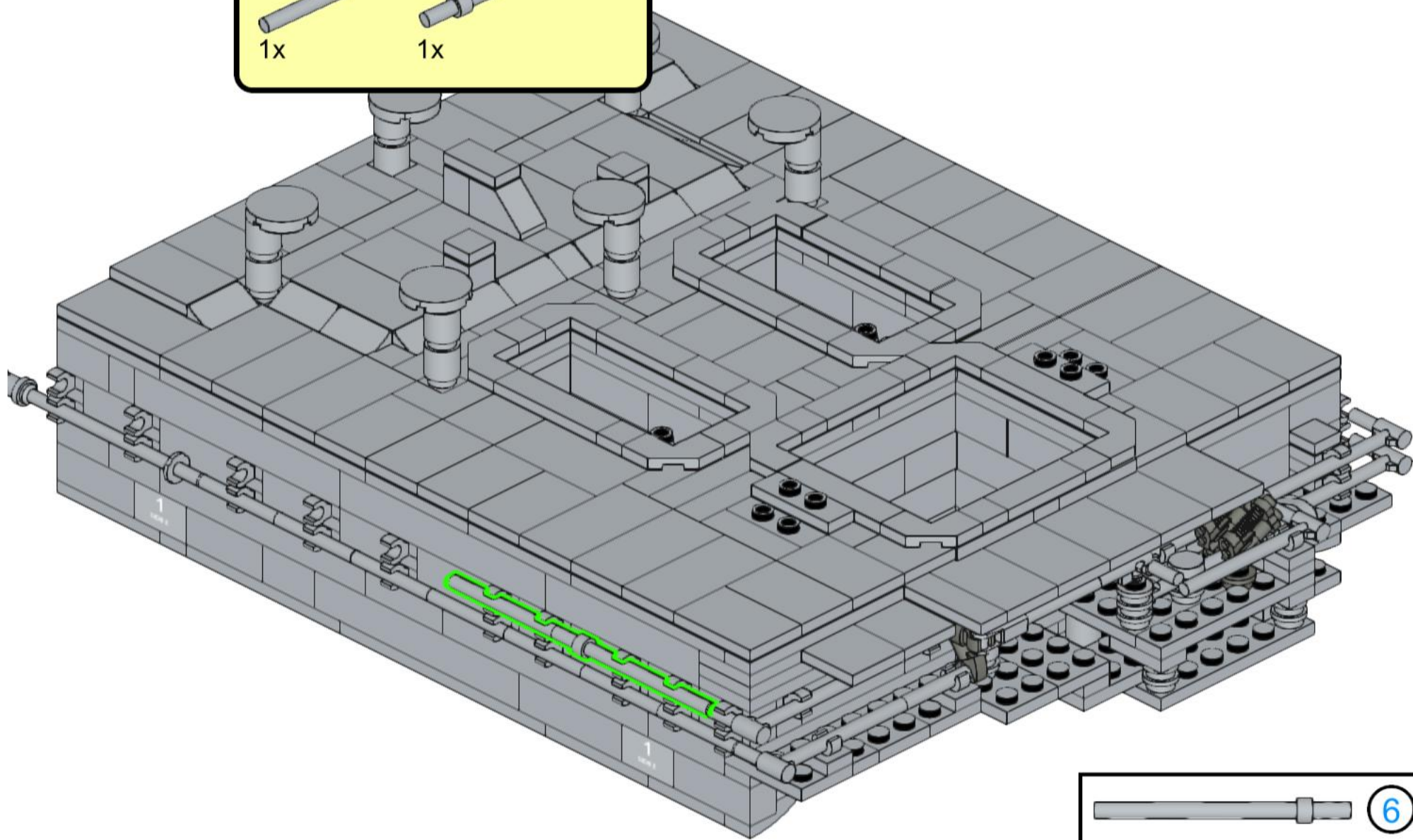
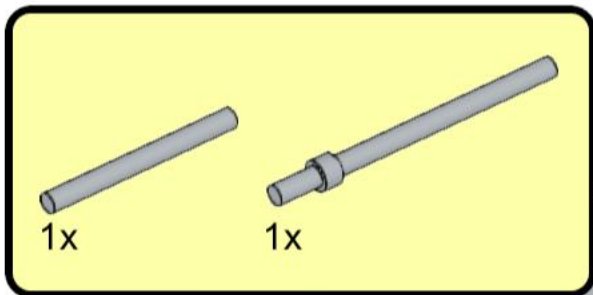

135

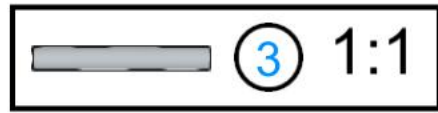
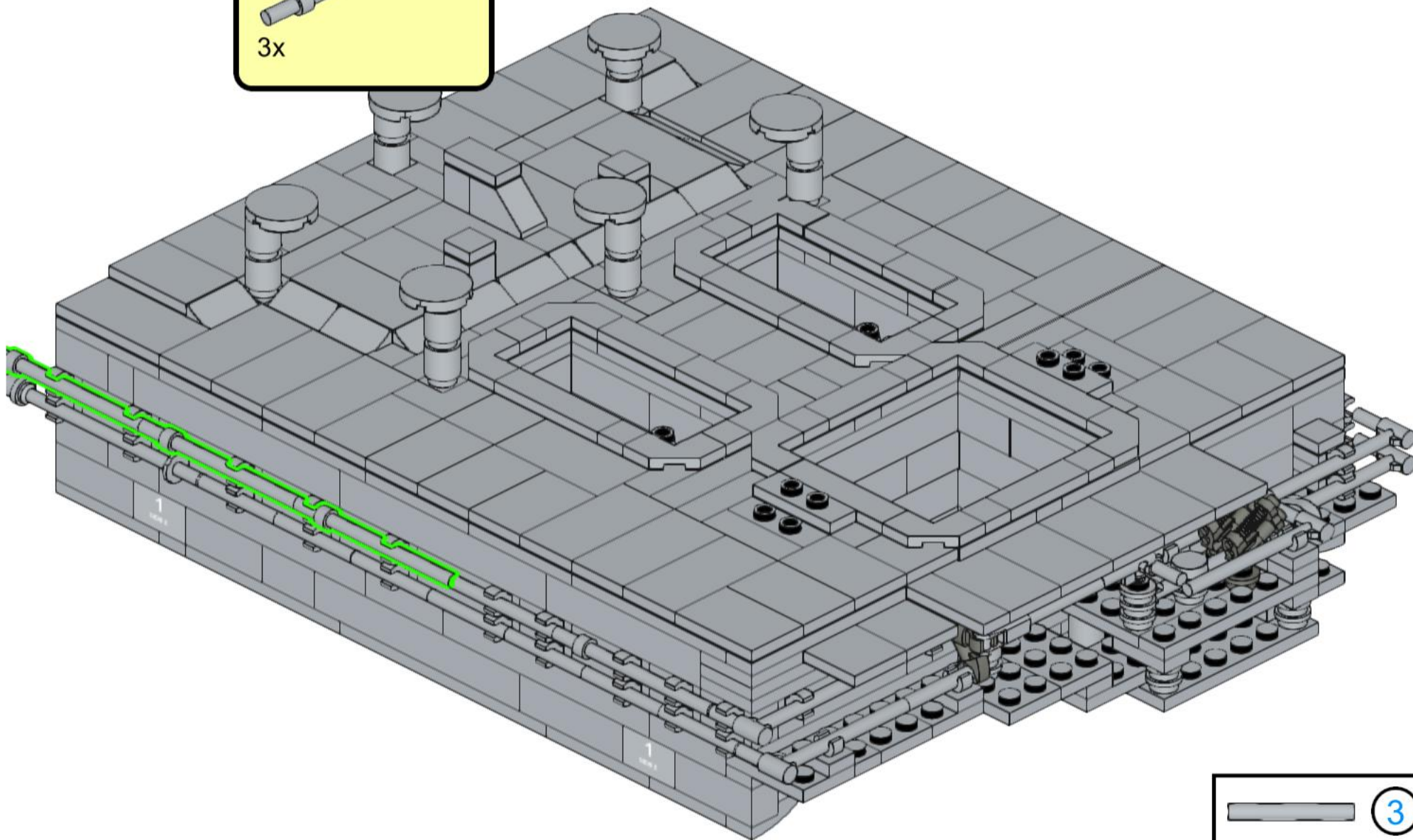
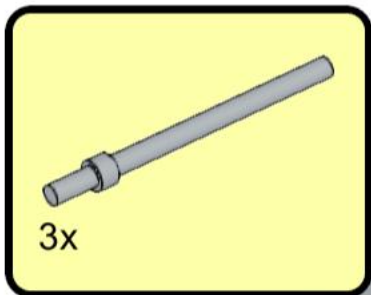

136

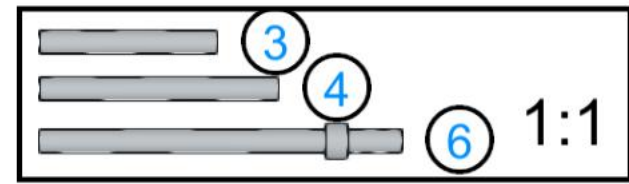
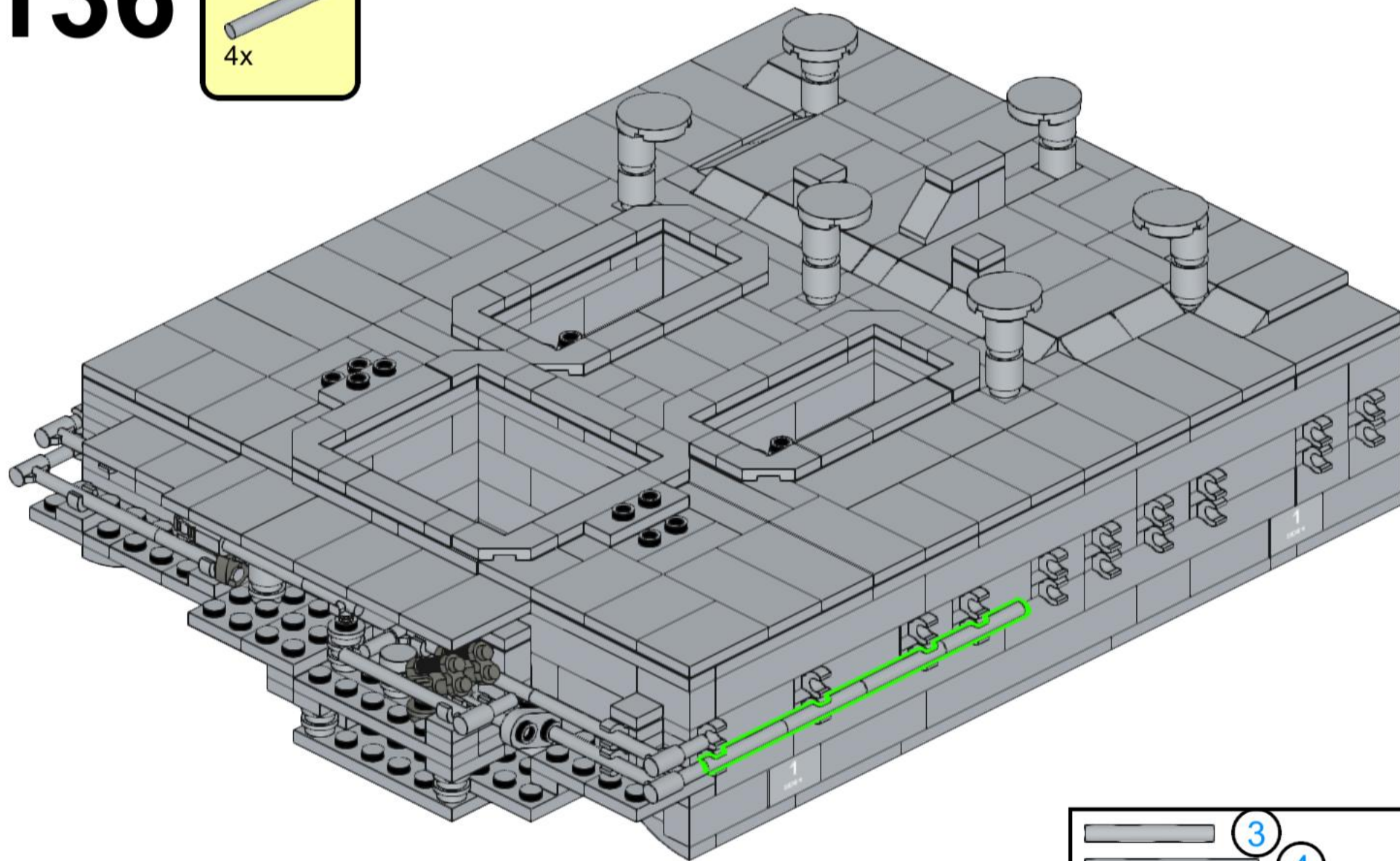
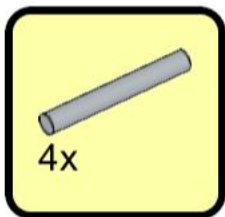

137

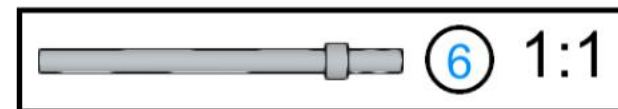
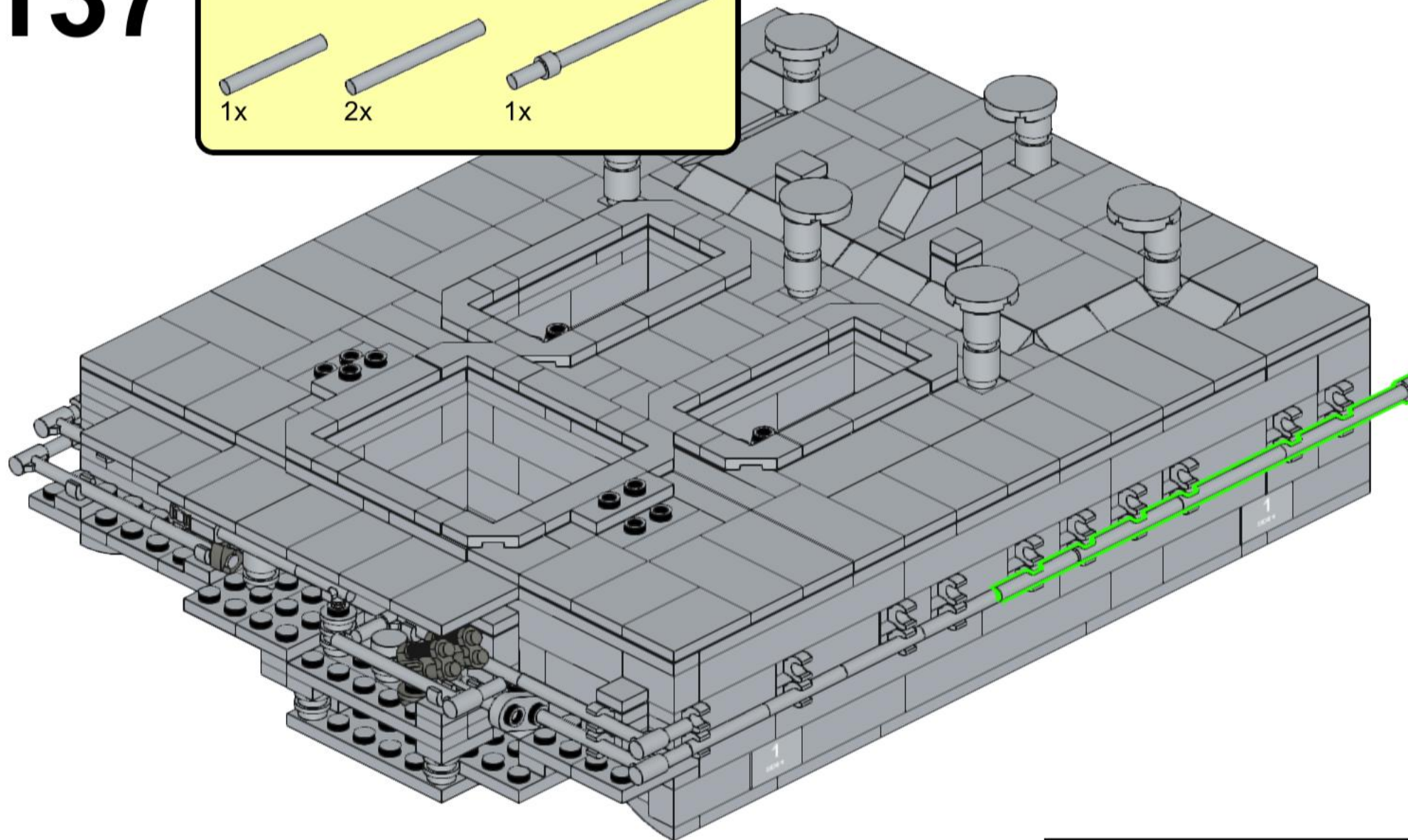
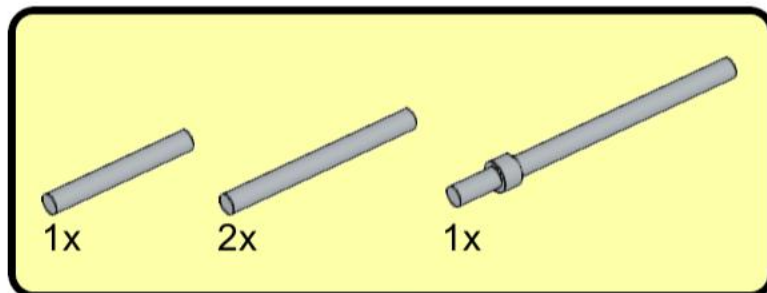

138

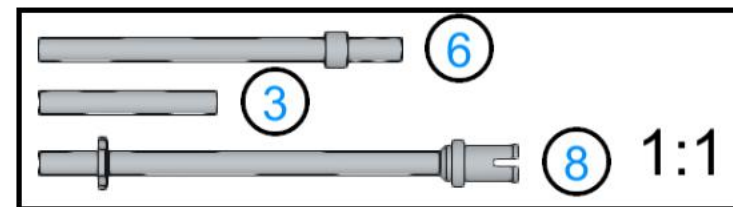
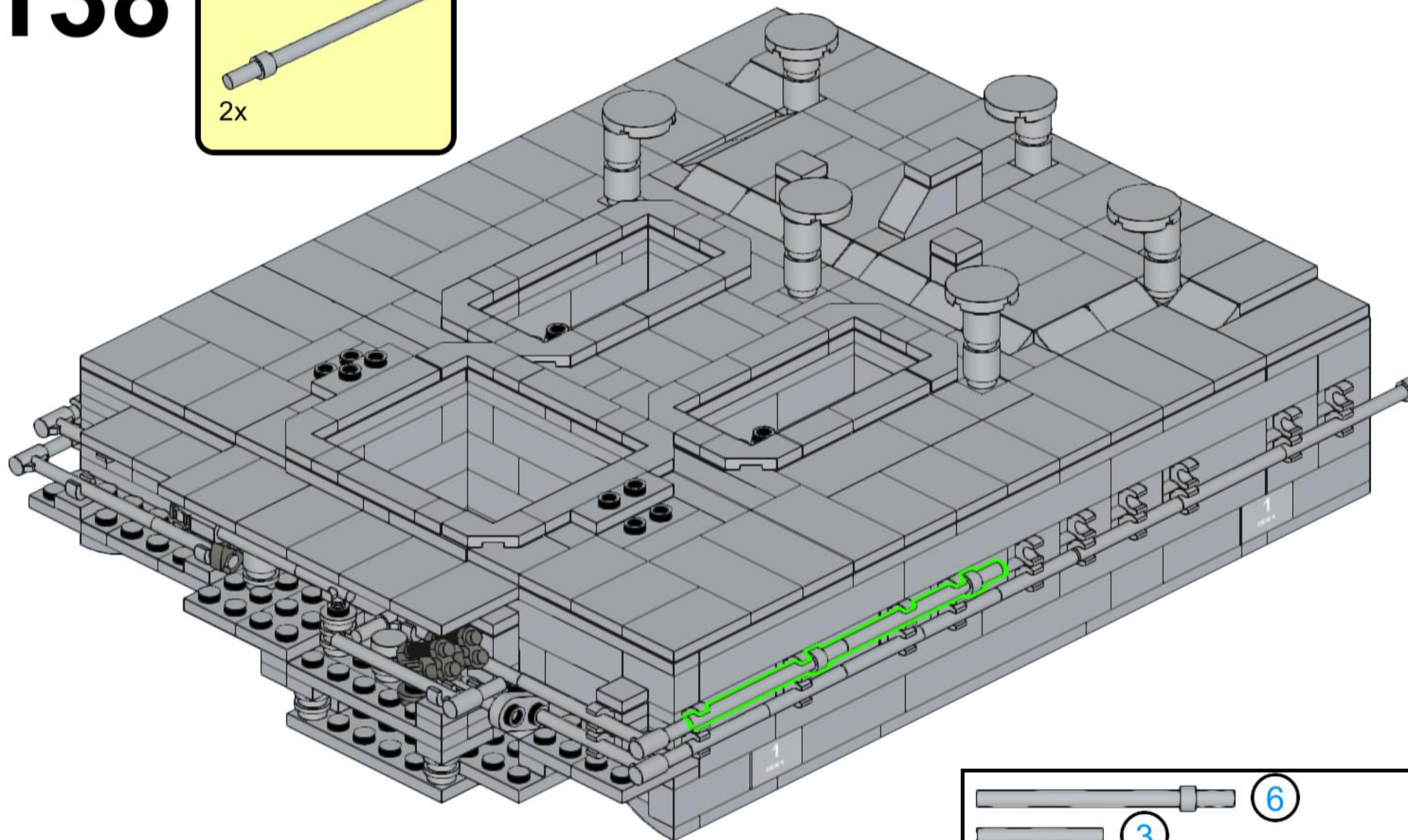
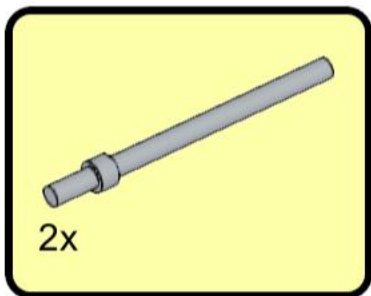

139

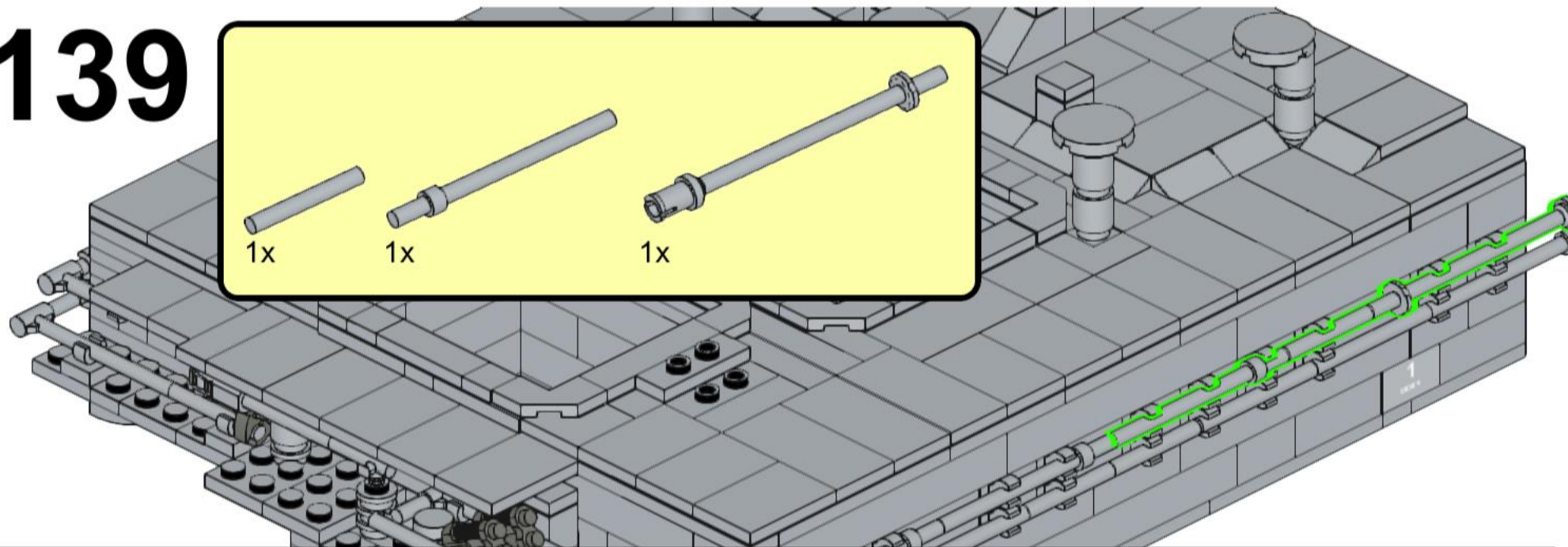
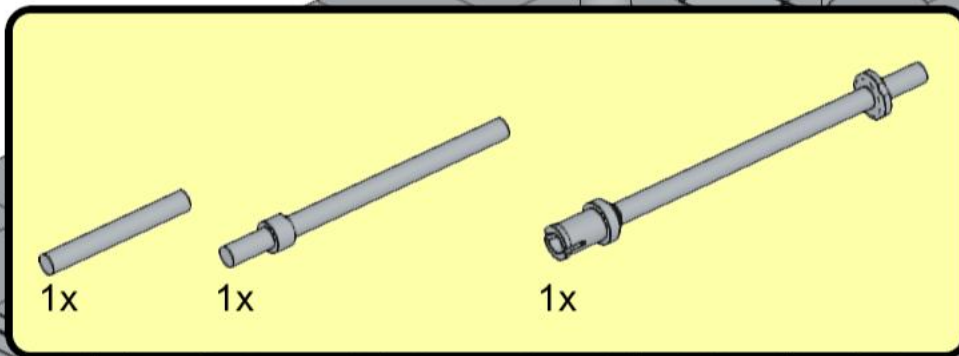

140

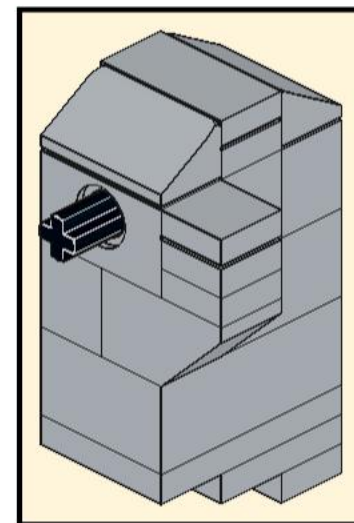
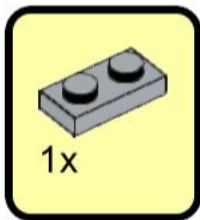

141

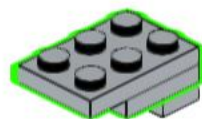
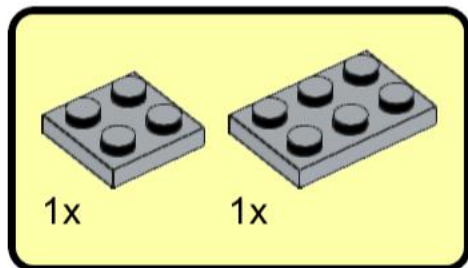

142

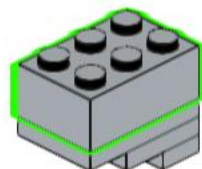
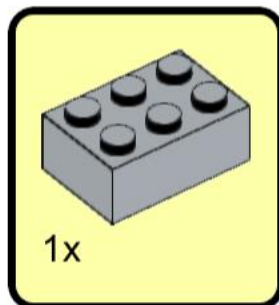

143

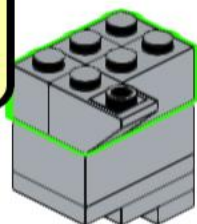
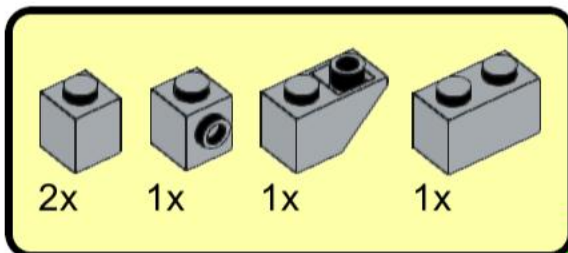

144

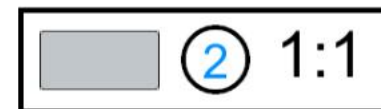
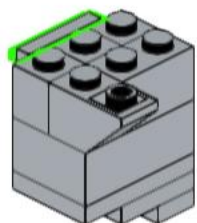
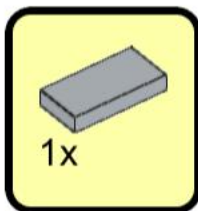

145

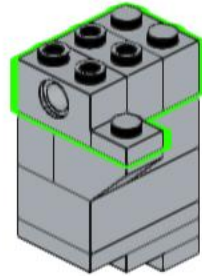
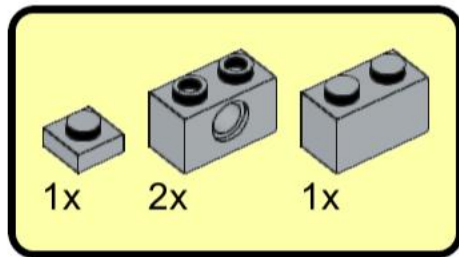

146

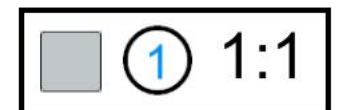
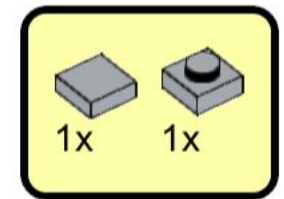
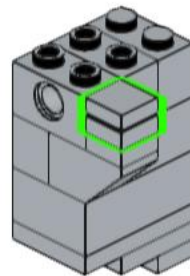

147

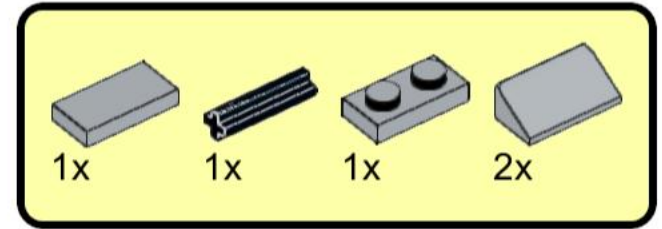
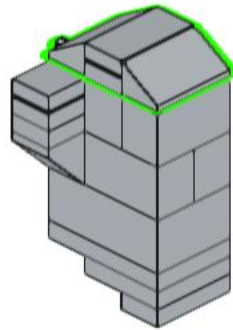

148

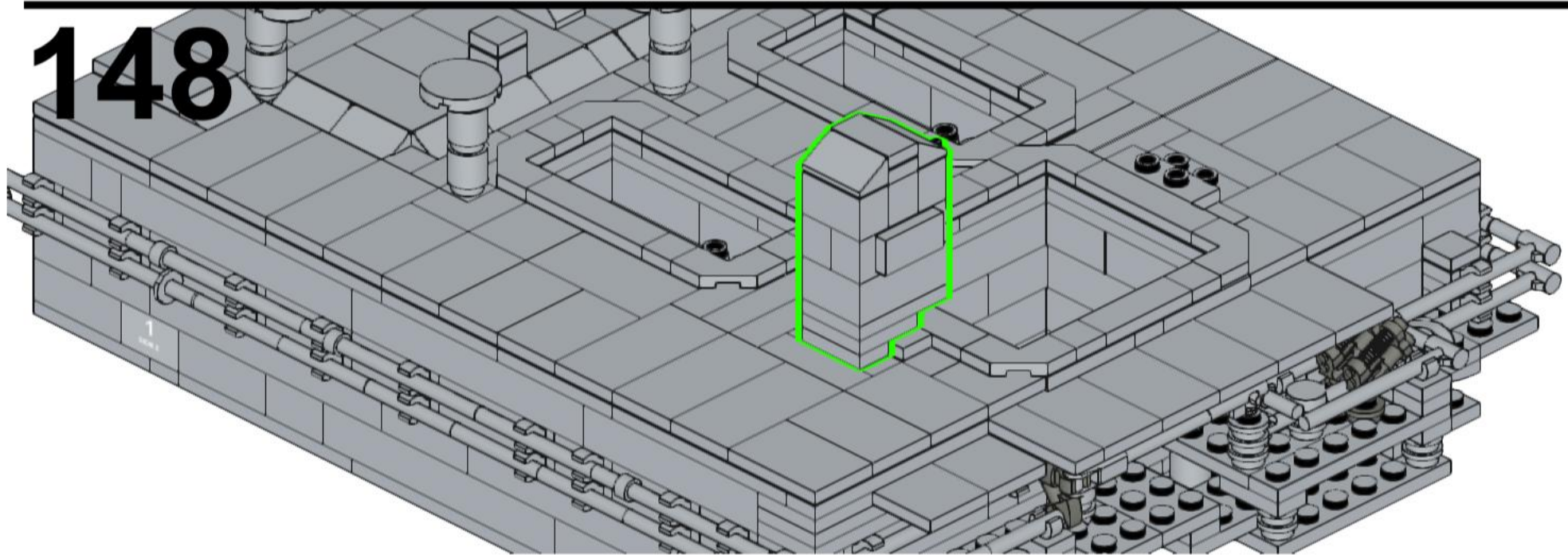

149

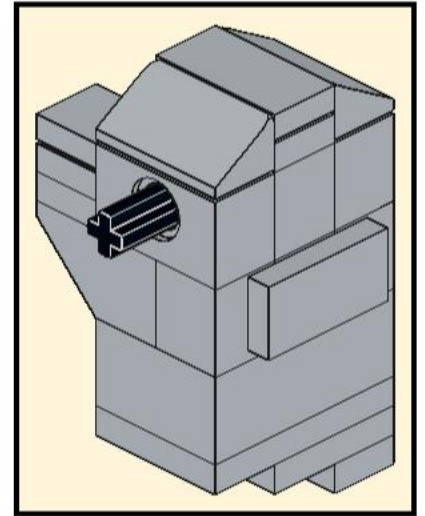
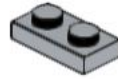
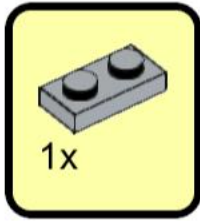

150

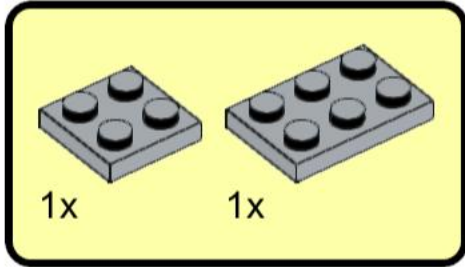

151

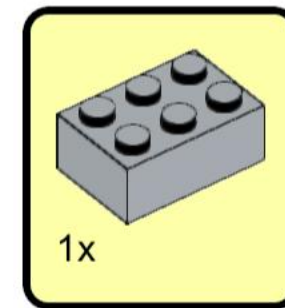
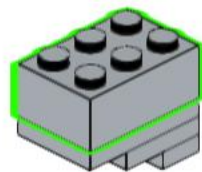

152

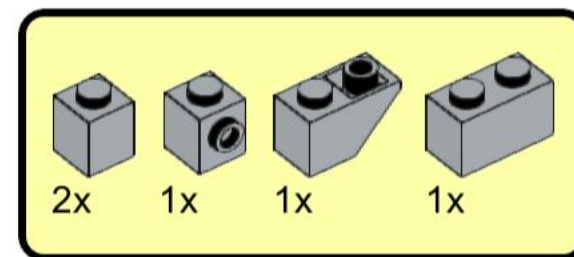
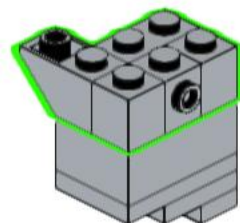

153

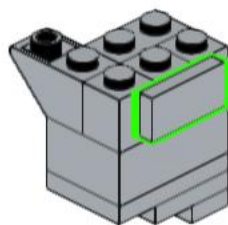
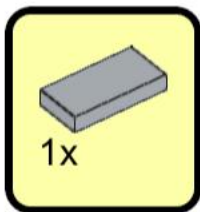

154

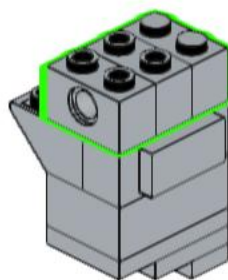
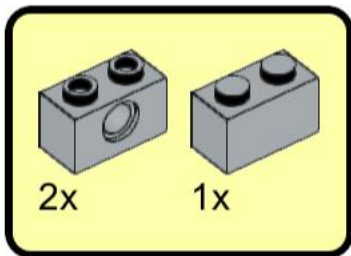

155

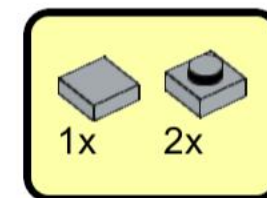
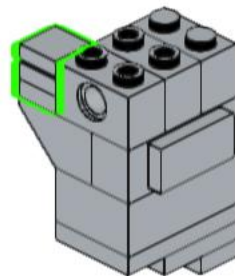

156

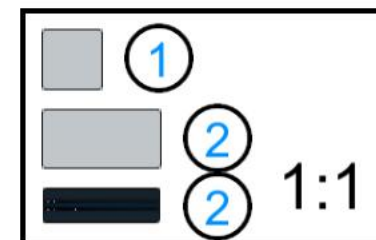
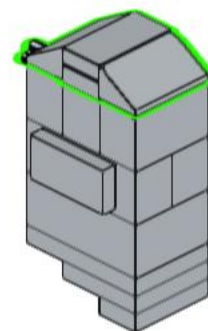
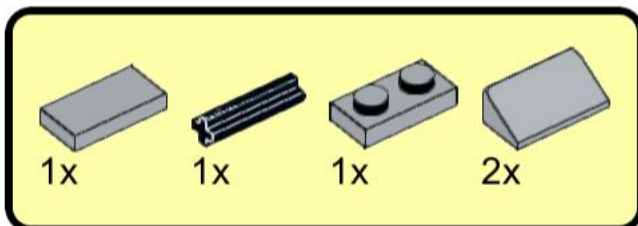

157

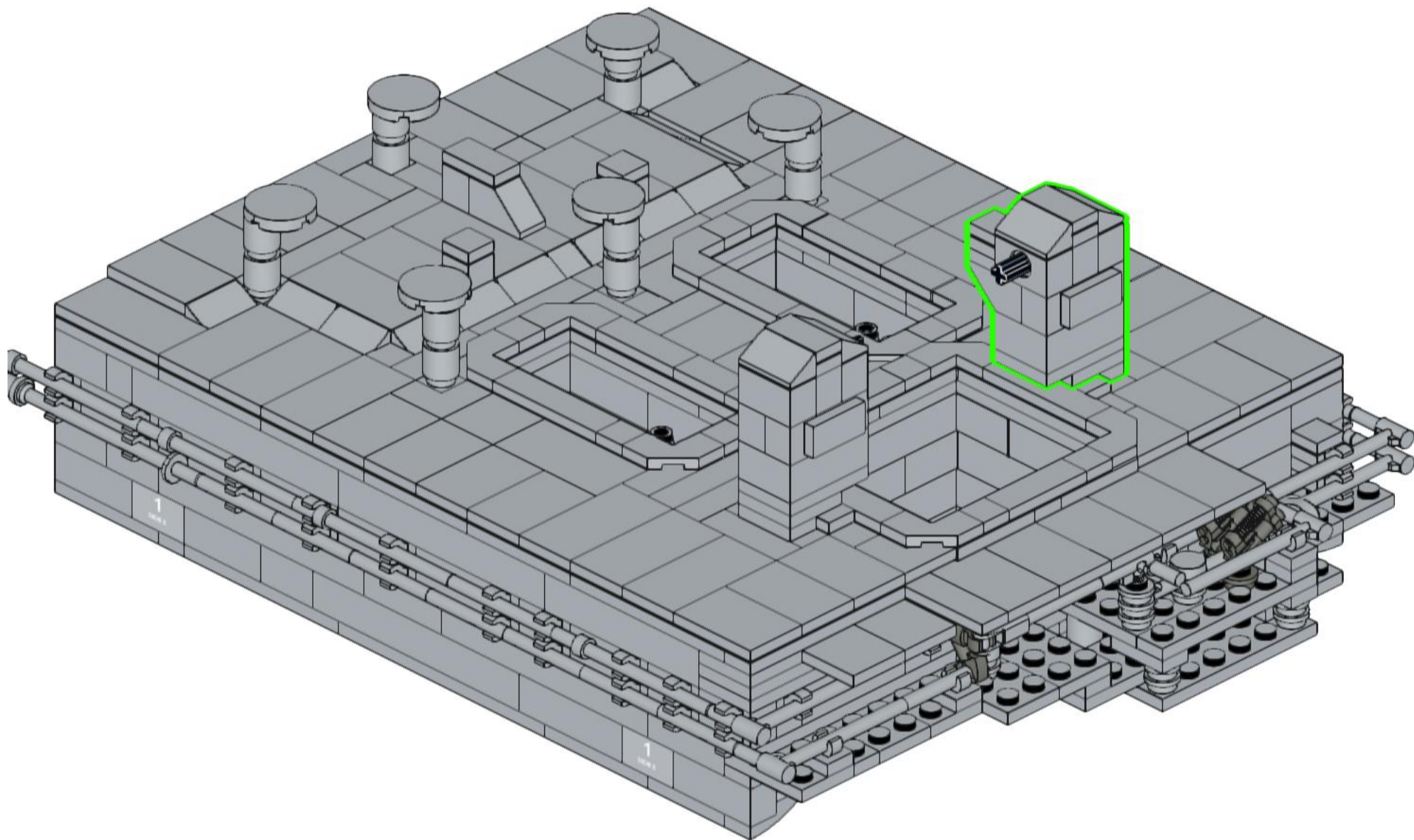

158

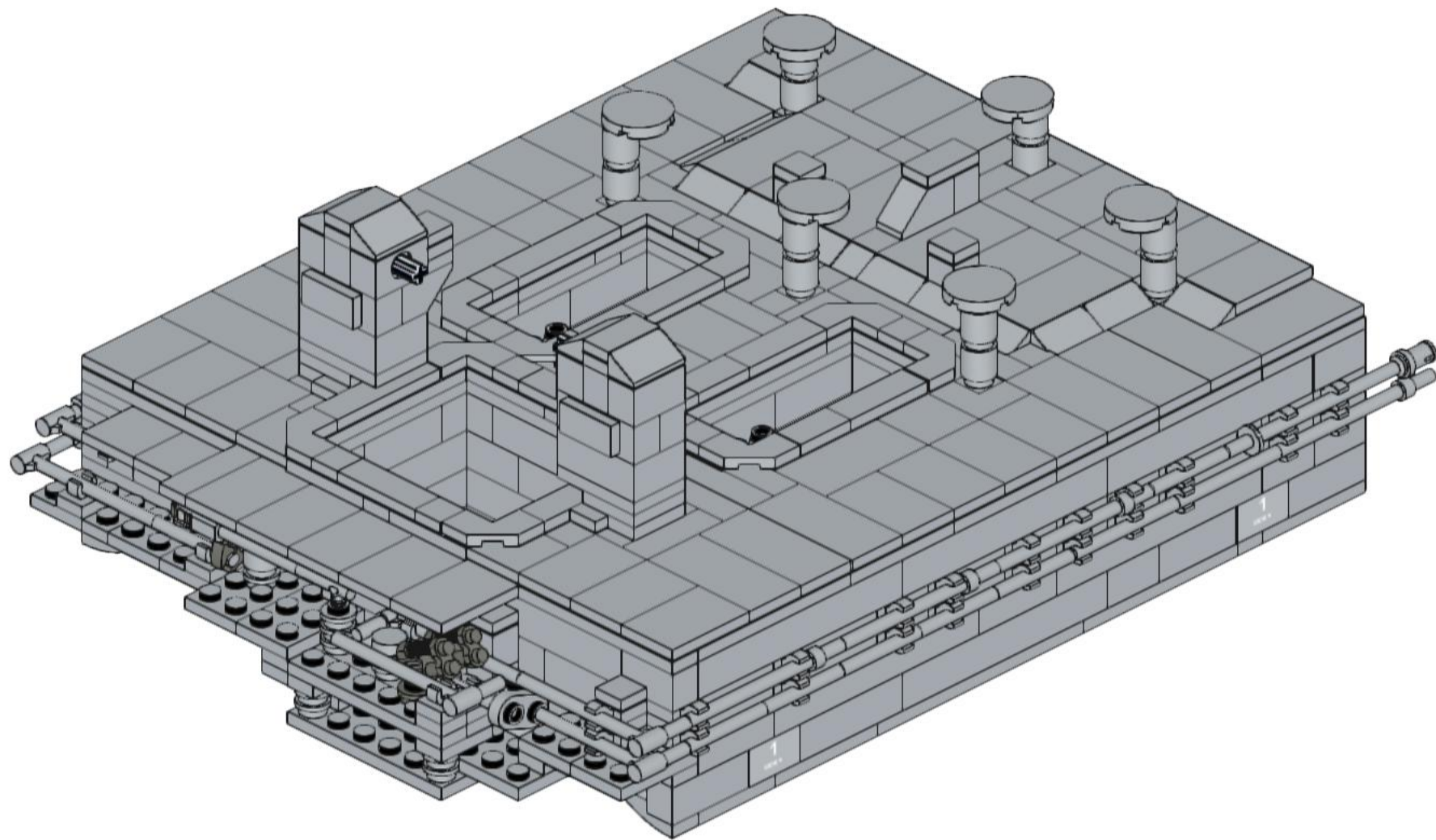



2x
3704, 11



2x
98138, 86



8x
4589b, 86



1x
47905, 86



1x
60849, 86

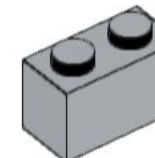

22x
3004, 86

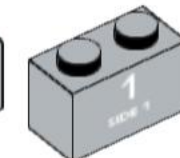

2x

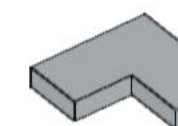

8x
14719, 86

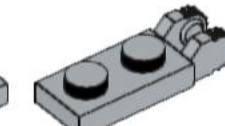

1x
44302a, 86

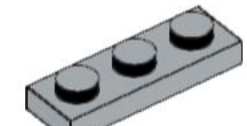

26x
3623, 86



2x
85861, 85



12x
85861, 86

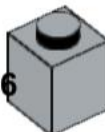

17x
3005, 86

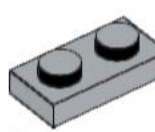

17x
3023, 86

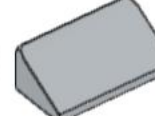

16x
85984, 86

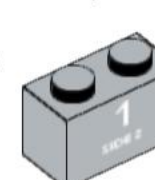

2x

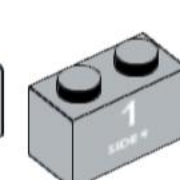

2x

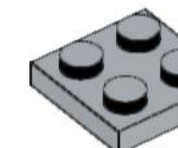

25x
3022, 86

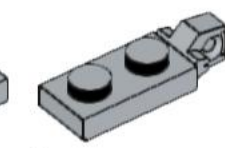

1x
44301a, 86

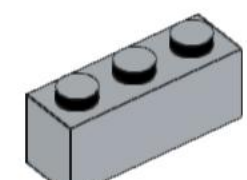

26x
3622, 86



1x
11090, 85

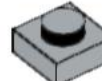

51x
3024, 86



15x
3062b, 86



1x
35480, 86



1x
11477, 86

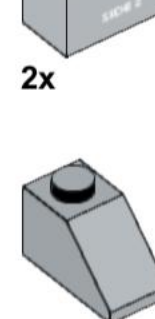

1x
3040, 86

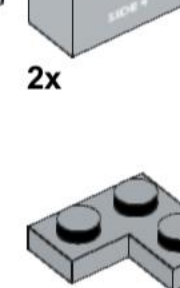

5x
2420, 86



2x
3068b, 86

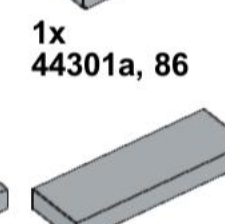

17x
63864, 86

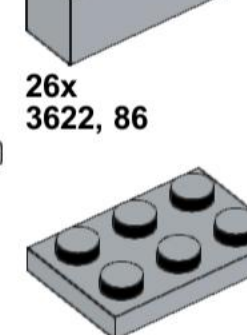

30x
3021, 86



1x
48729, 85



1x
54200, 86



11x
87087, 86



9x
32828, 86



2x
24201, 86



2x
3665, 86

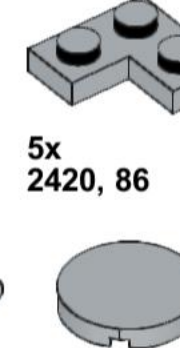

6x
4150, 86



2x
63868, 86

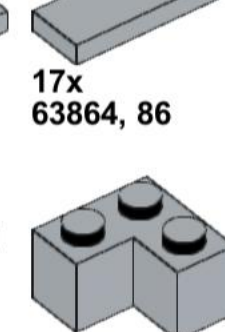

17x
2357, 86

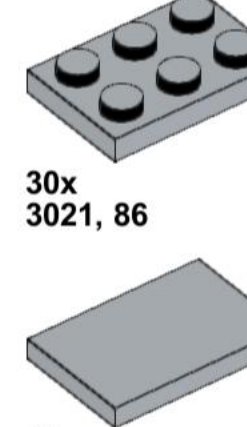

26x
26603, 86



2x
95199, 85



5x
15712, 86



1x
23443, 86



2x
3794b, 86



2x



4x
3700, 86

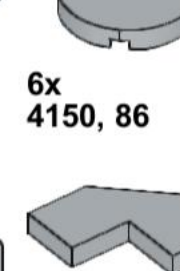

12x
27263, 86

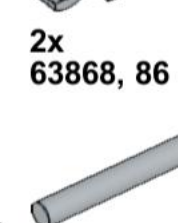

17x
87994, 86



4x
34103, 86

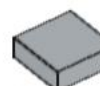

25x
3070b, 86

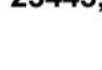

16x
3069b, 86

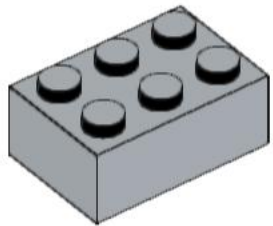

14x
3002, 86

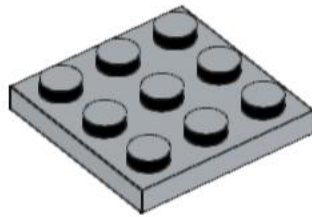

4x
11212, 86

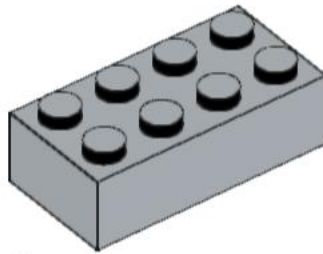

6x
3001, 86

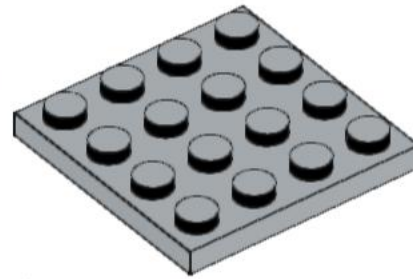

1x
3031, 86

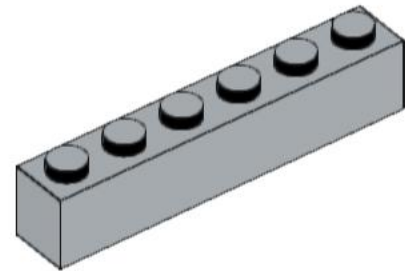

4x
3009, 86

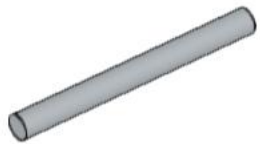

6x
30374, 86

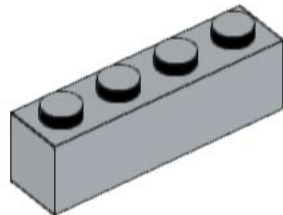

21x
3010, 86

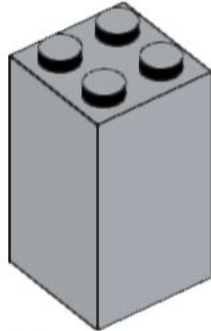

10x
30145, 86

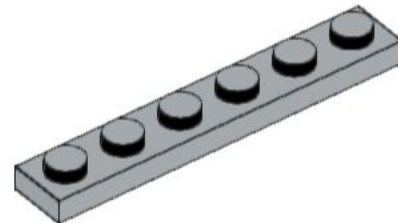

13x
3666, 86

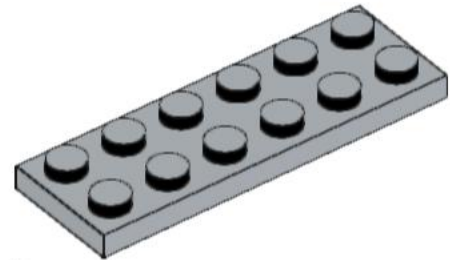

5x
3795, 86

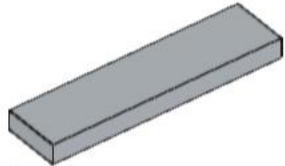

8x
2431, 86

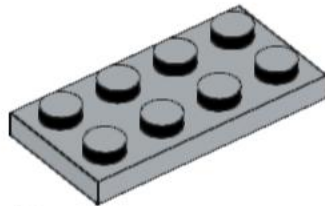

12x
3020, 86

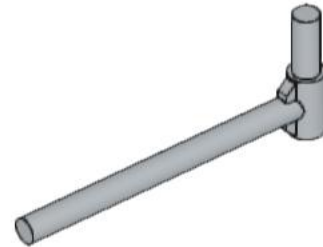

6x
87618, 86

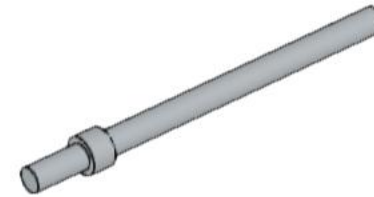

8x
63965, 86

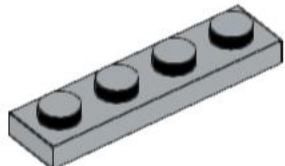

11x
3710, 86

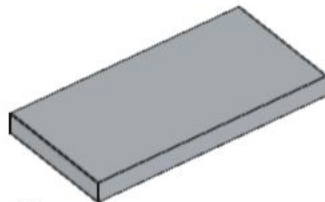

27x
87079, 86

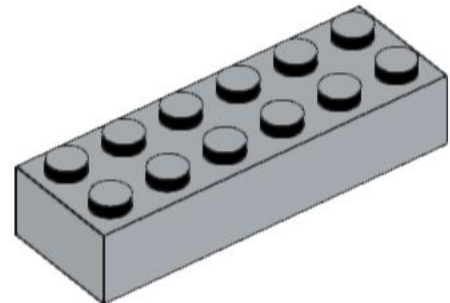

9x
2456, 86

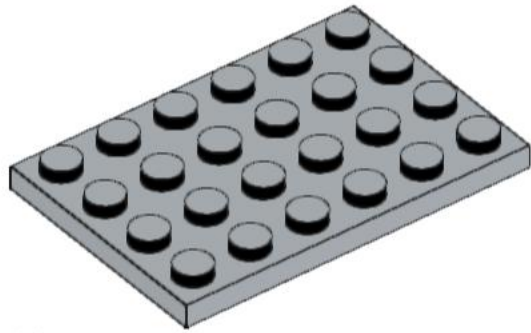

24x
3032, 86

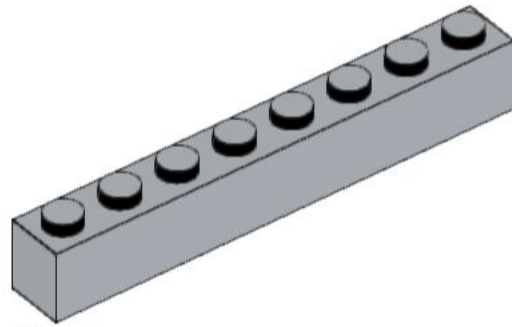

15x
3008, 86

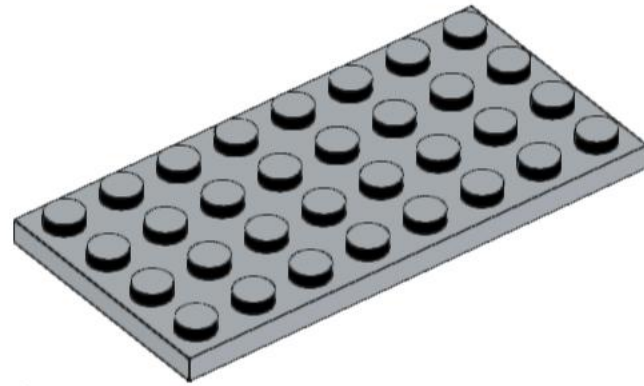

4x
3035, 86

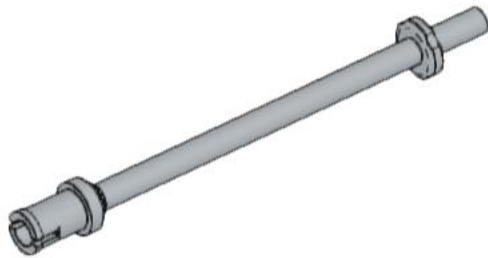

2x
2714b, 86

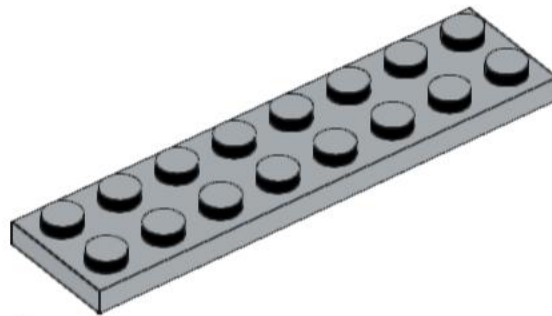

3x
3034, 86

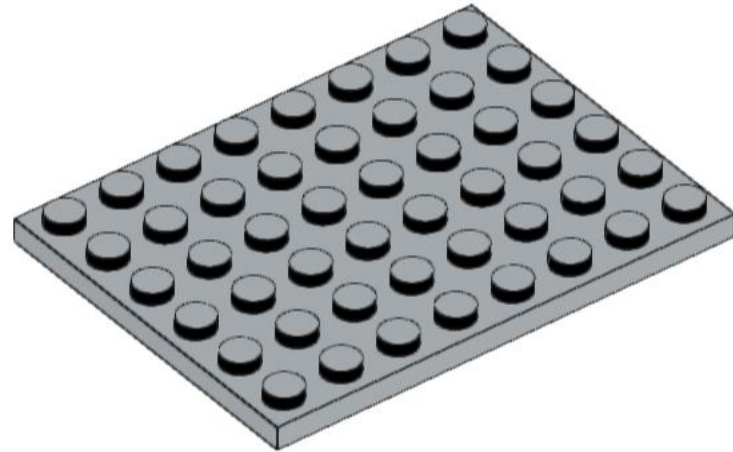

4x
3036, 86

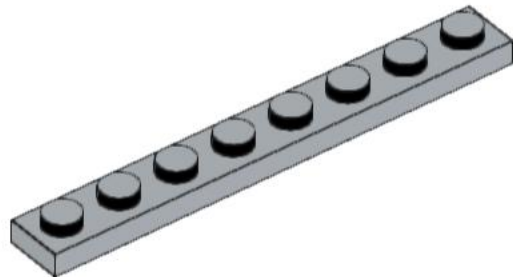

9x
3460, 86

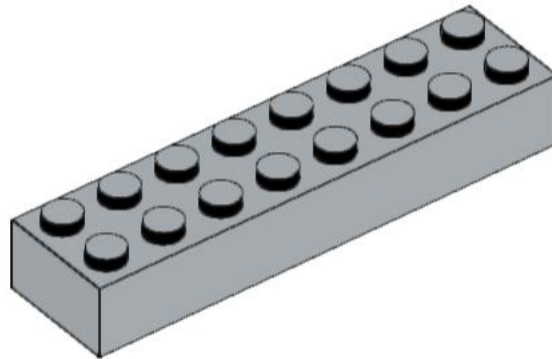

9x
3007, 86

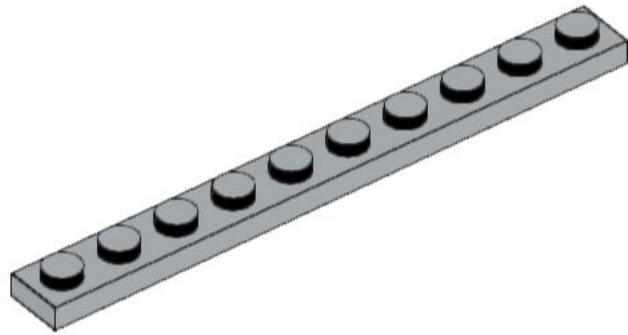

1x
4477, 86

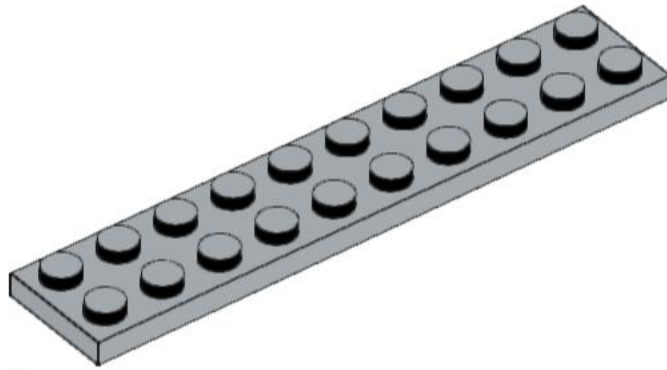

1x
3832, 86

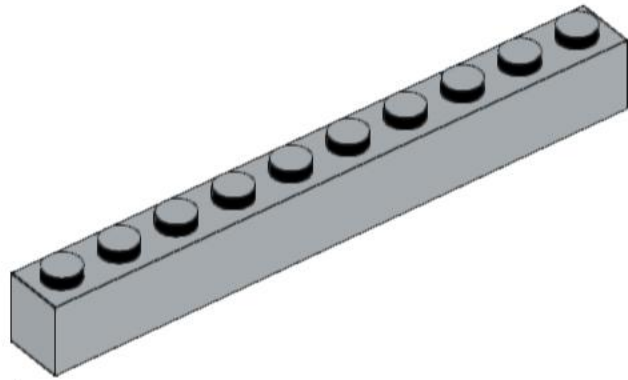

1x
6111, 86

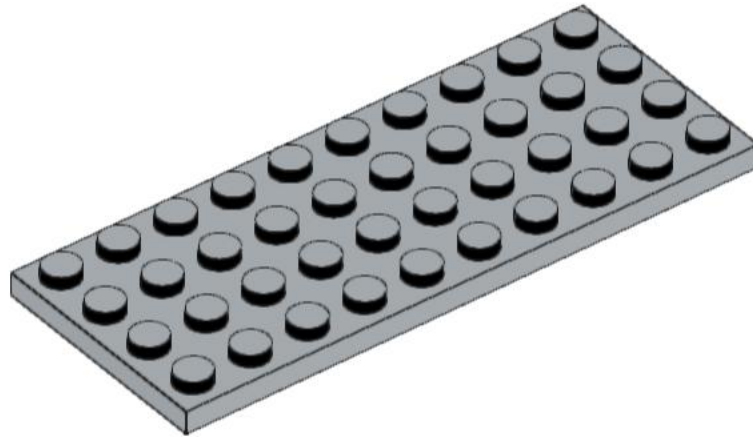

2x
3030, 86

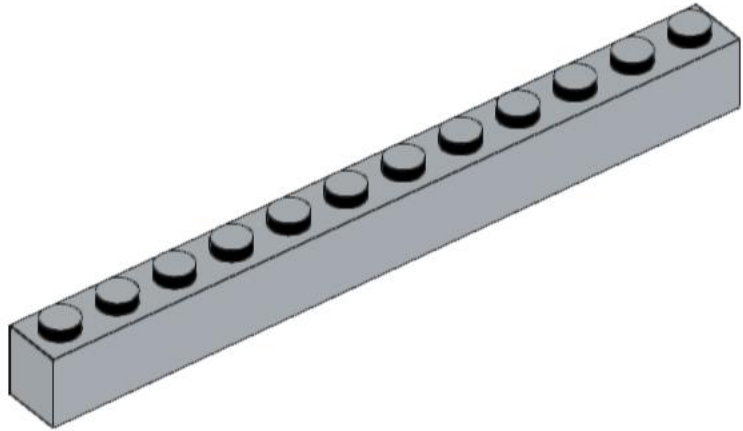

1x
6112, 86

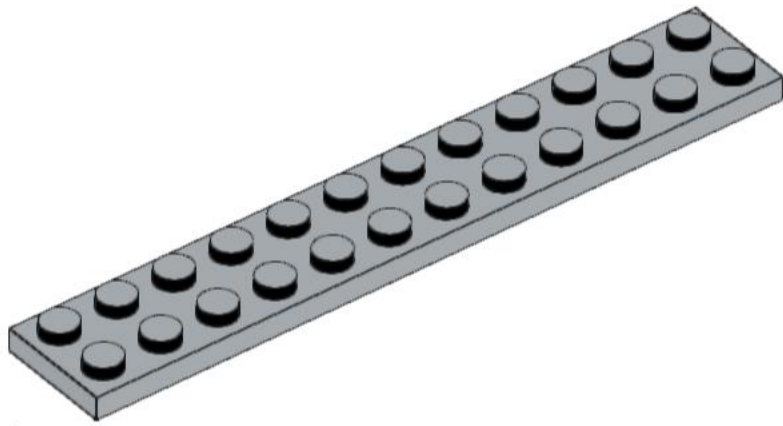

1x
2445, 86