

**Bauanleitung**

**Building  
Instructions**

**NASA**

**Space Shuttle  
Orbiter**

(Columbia, Challenger, Discovery, Atlantis, Endeavour)

Maßstab

1:220

Scale

**Mai**

**2021**

**May**



© 2021 Harald Kränzel

1 x



=



4 x



=

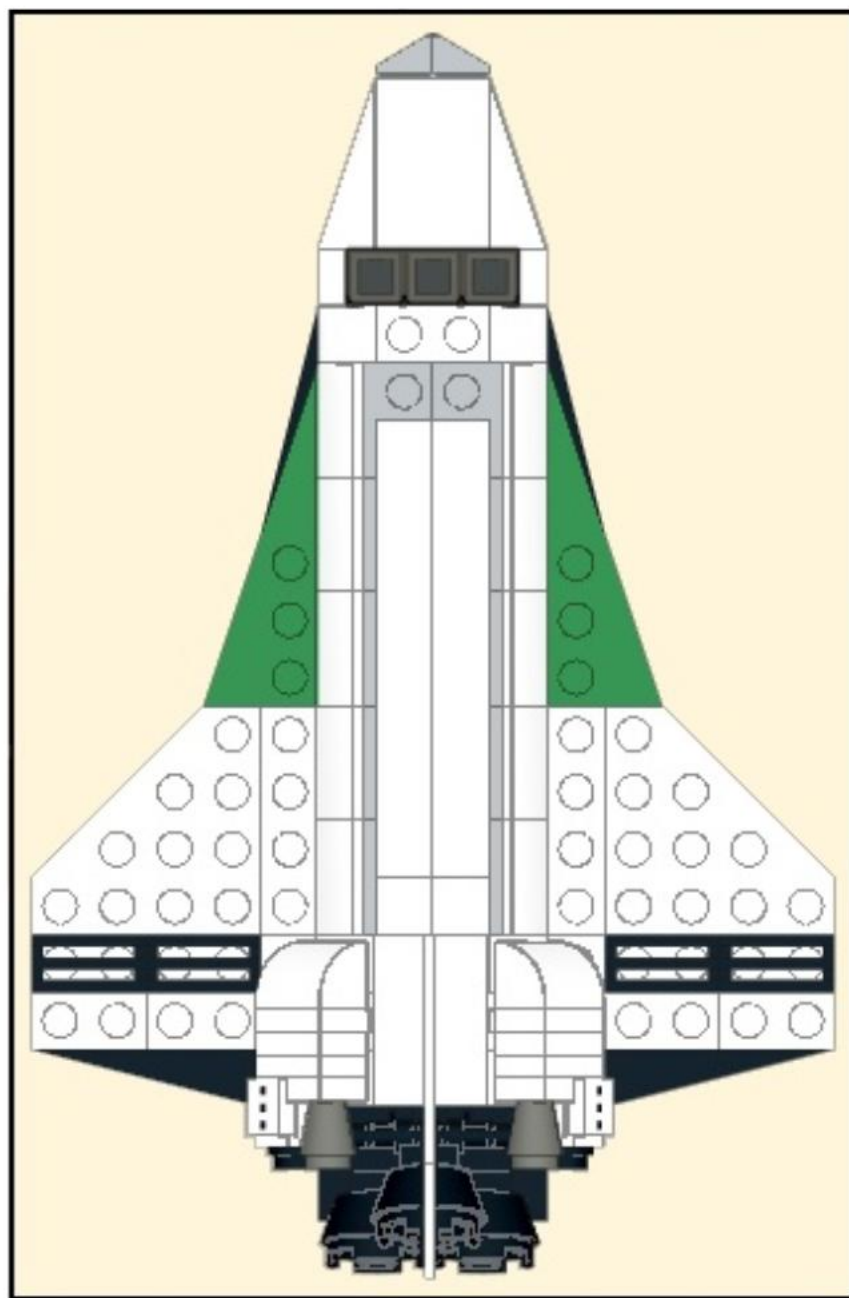
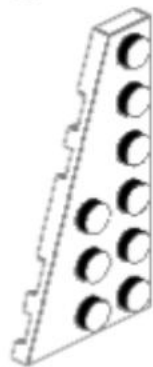

5 x

1 x

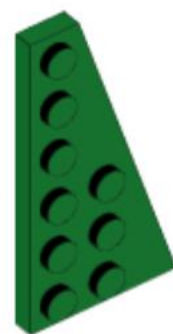

=



4 x



=

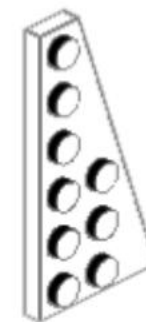

1

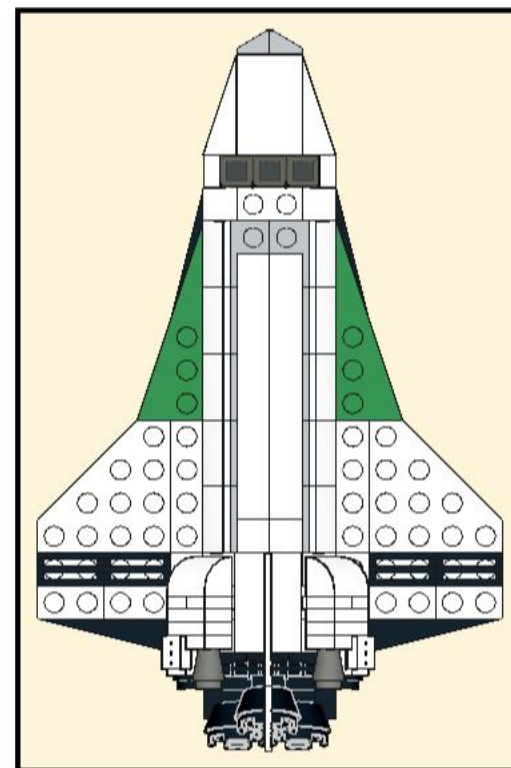
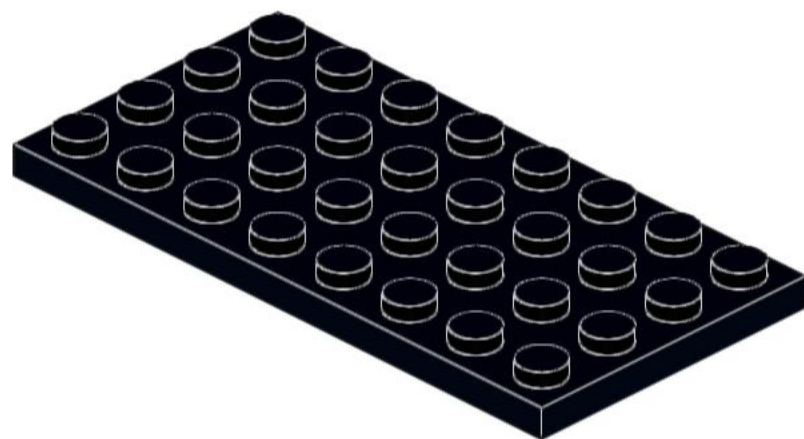
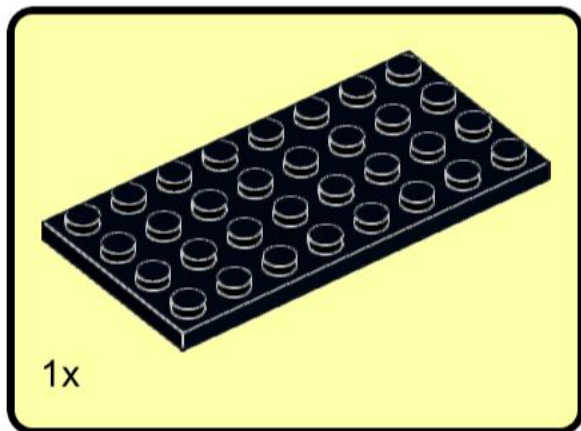

5 x

2

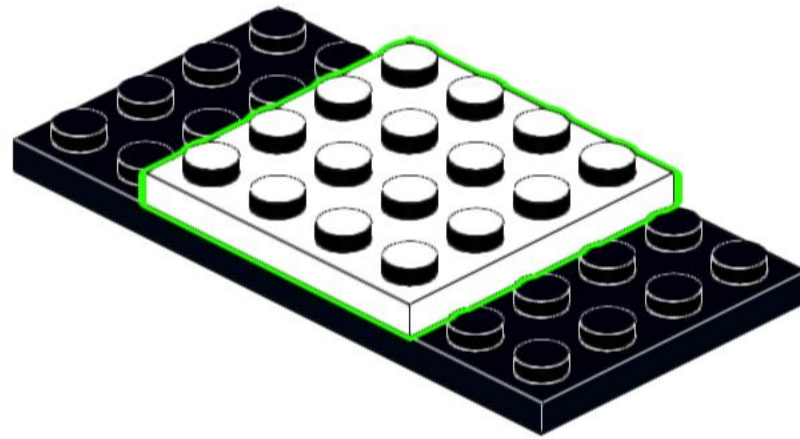
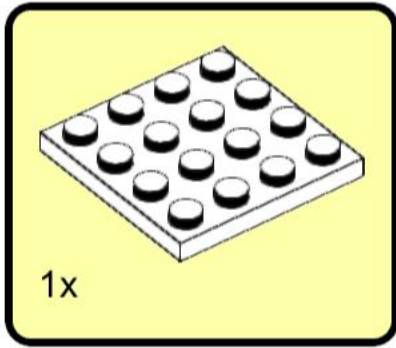



3

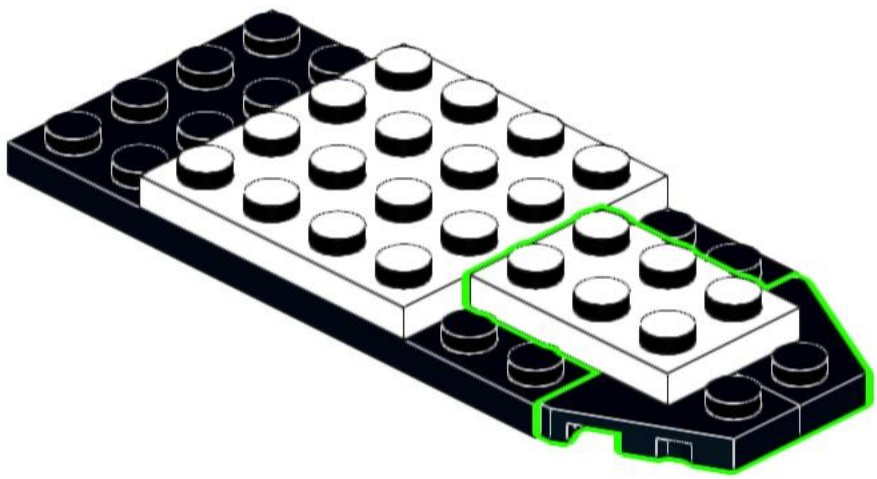
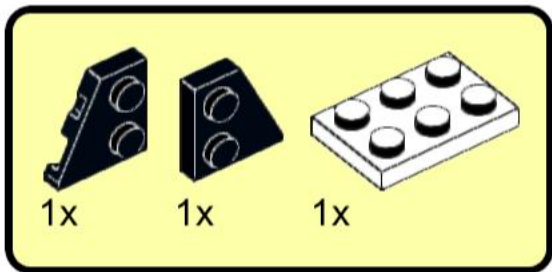

4

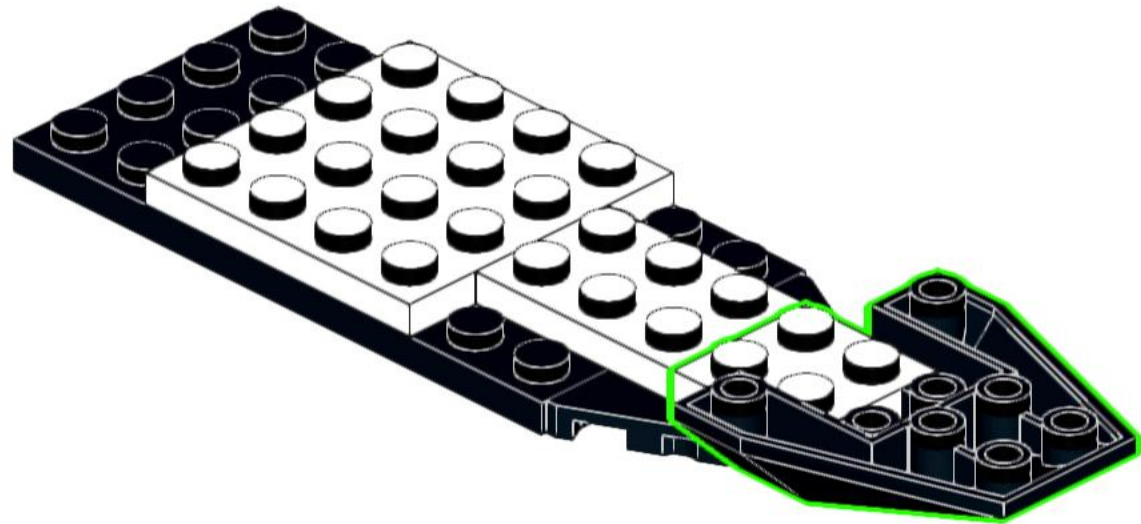
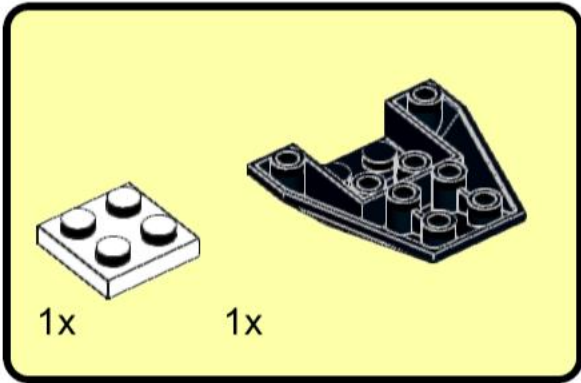

5

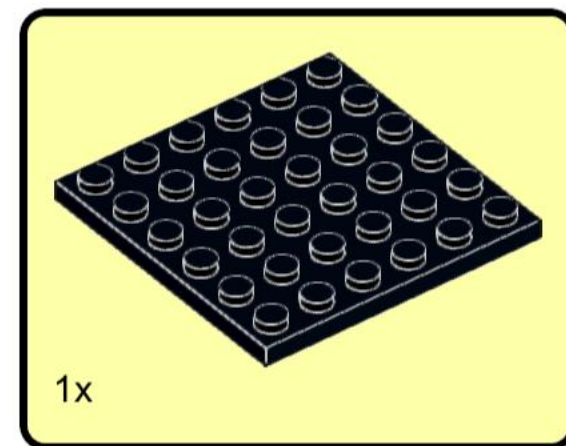
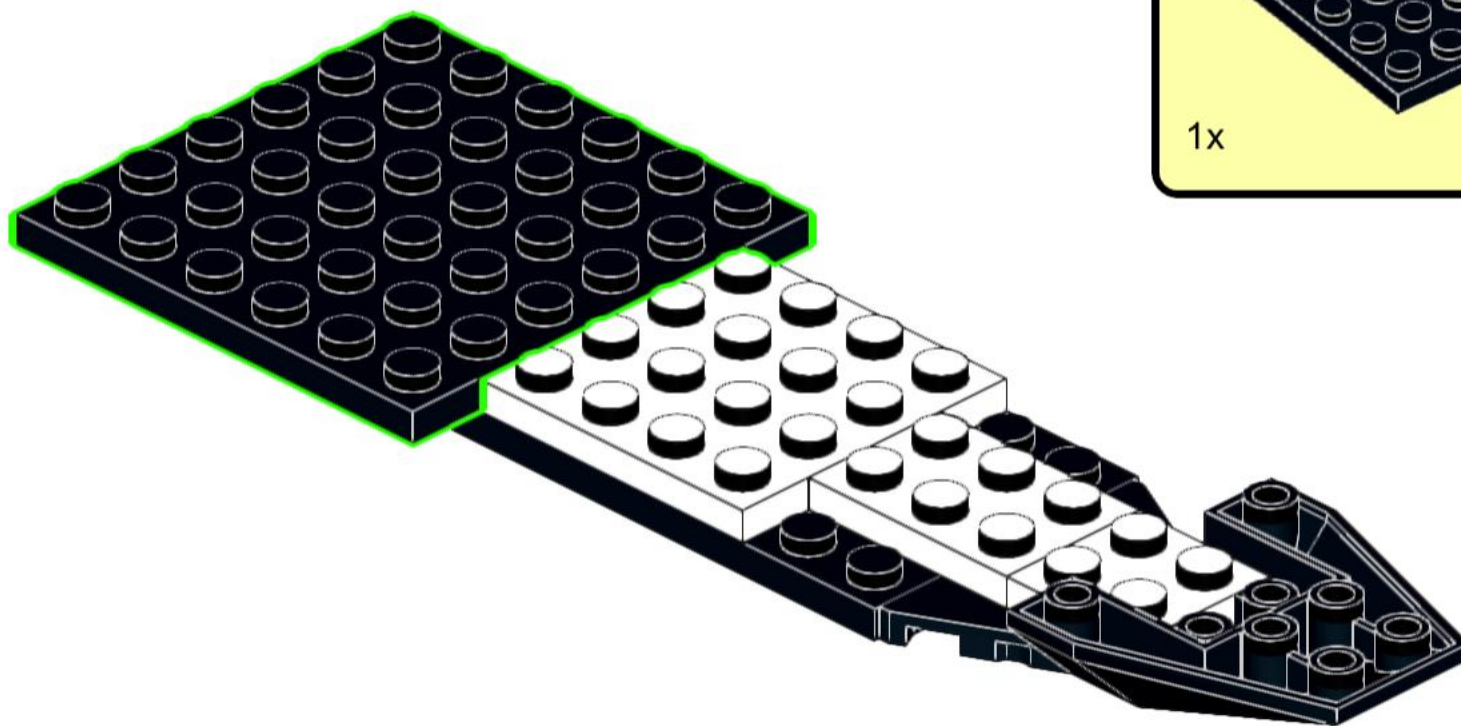

6

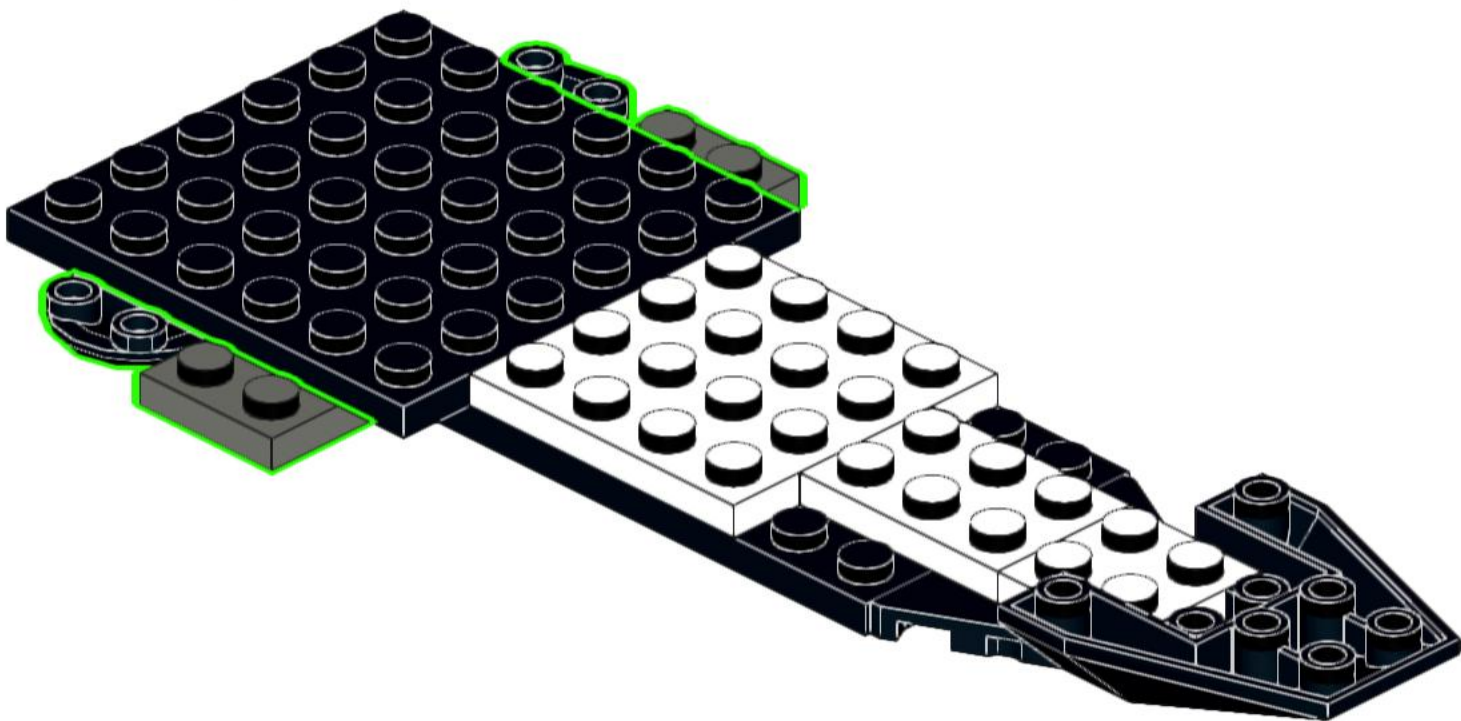
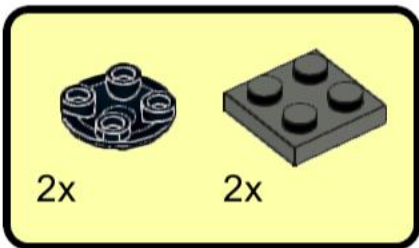

7

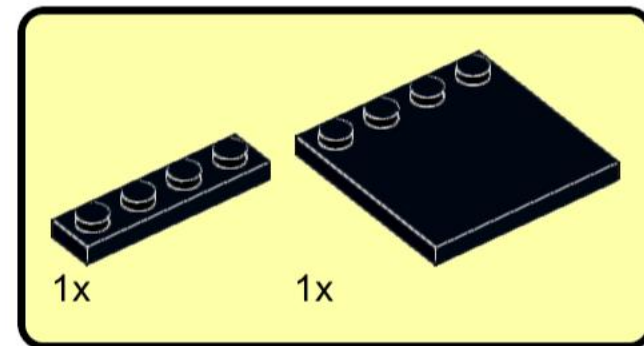
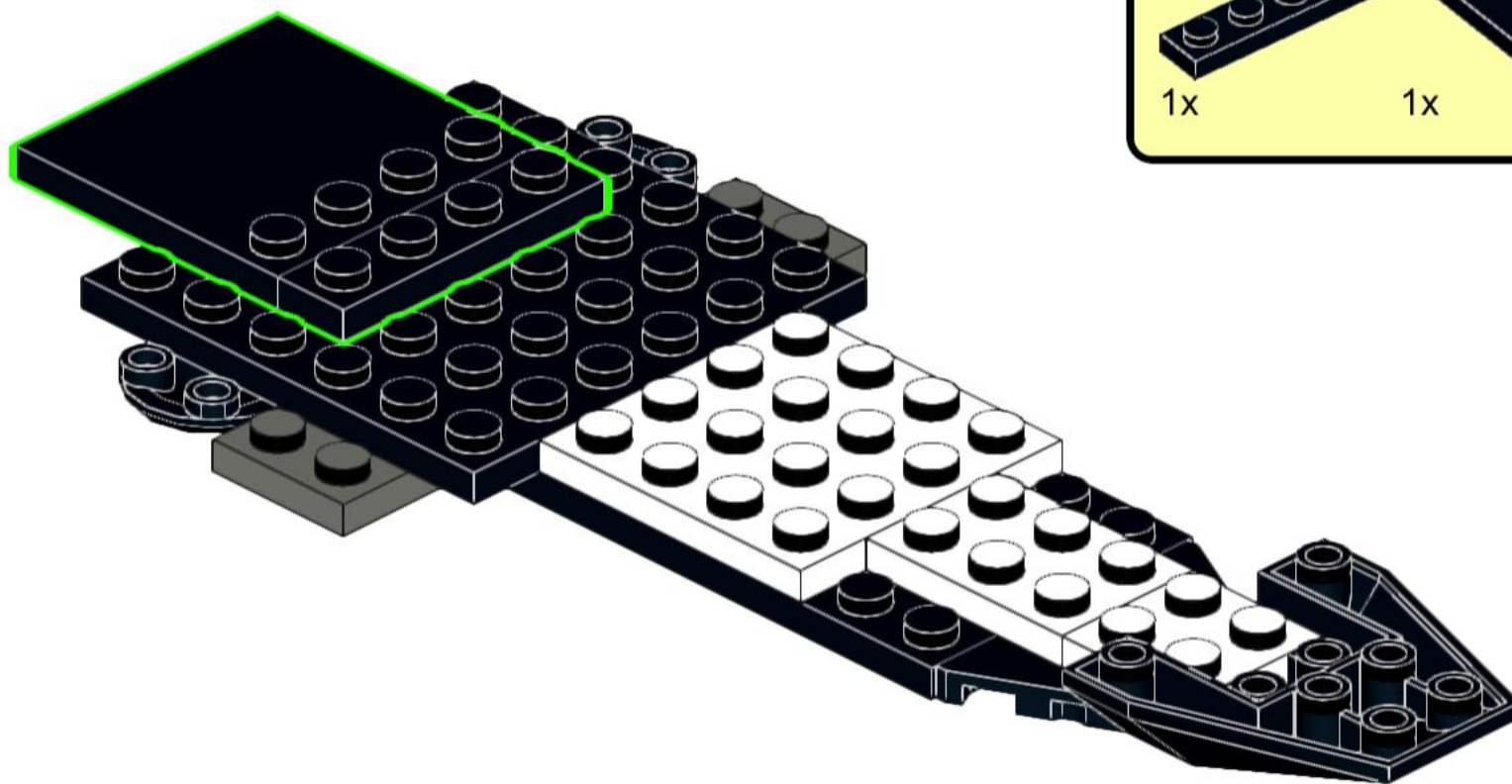



8

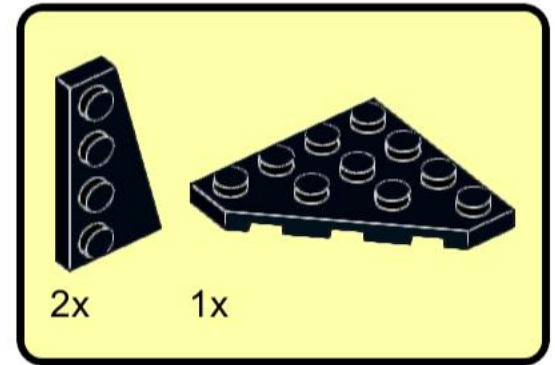
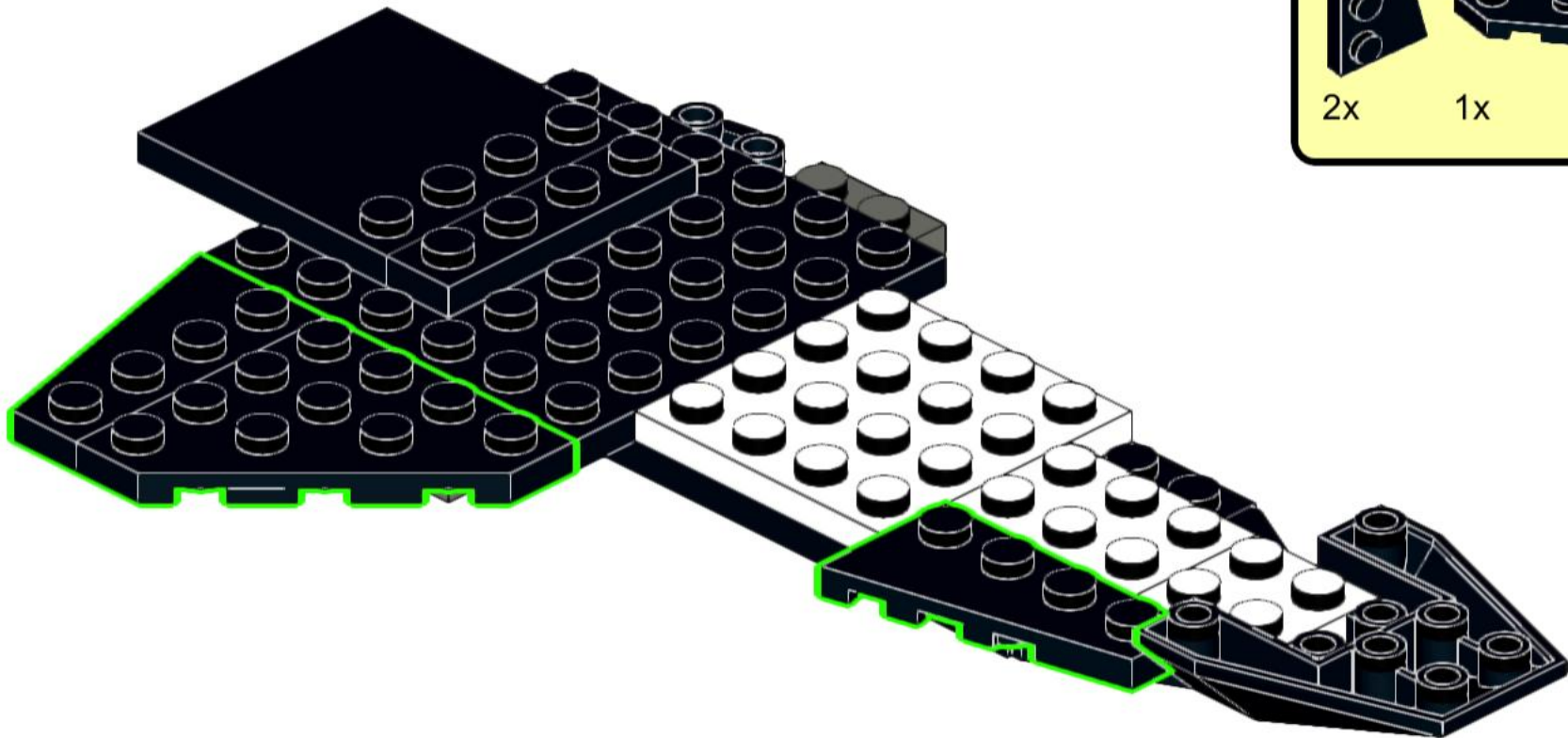



9

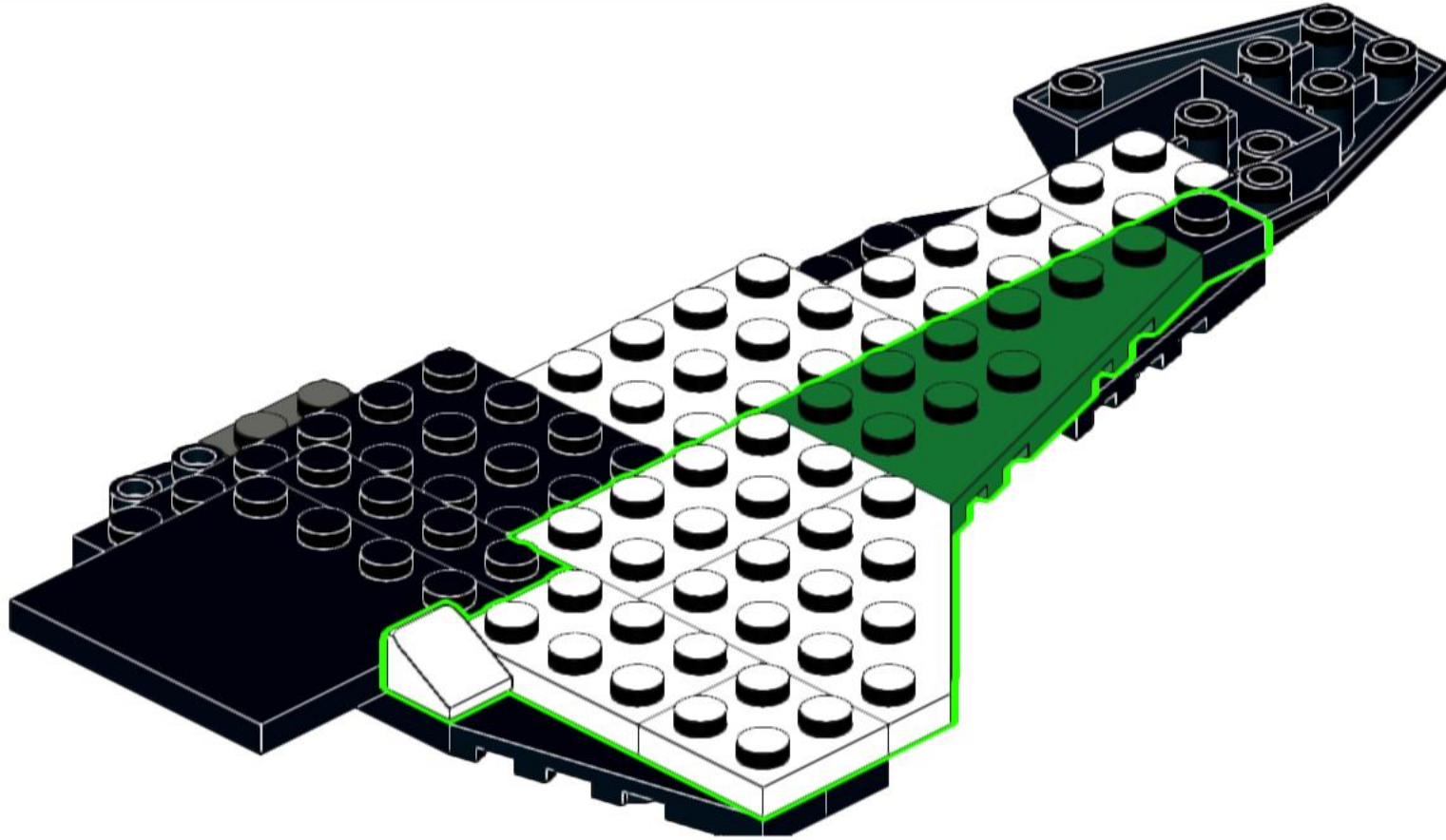
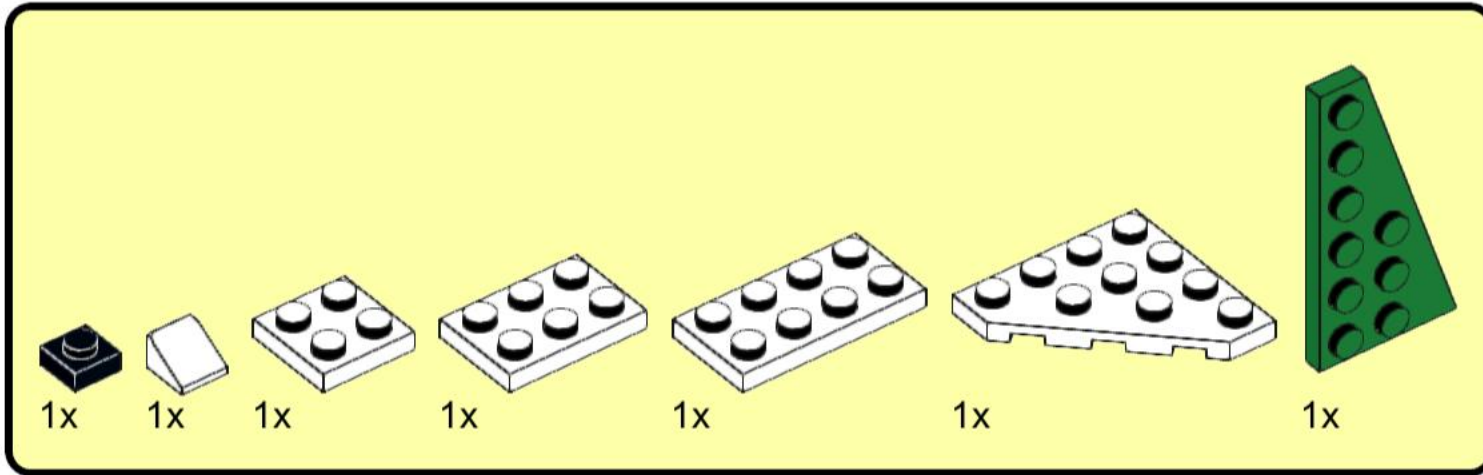

10

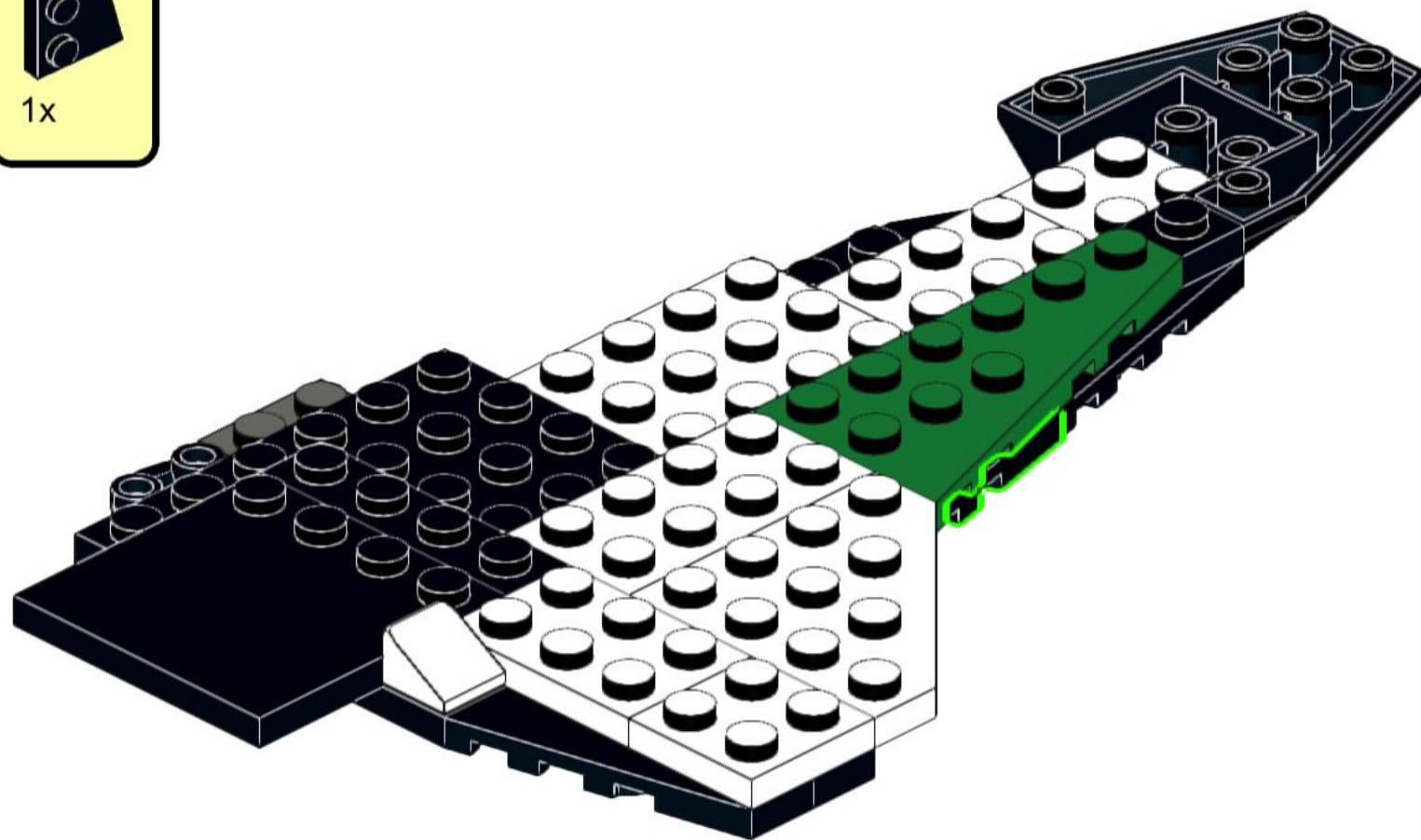
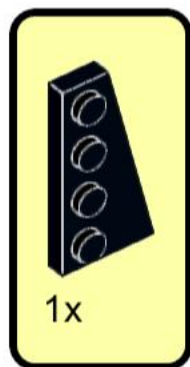

11

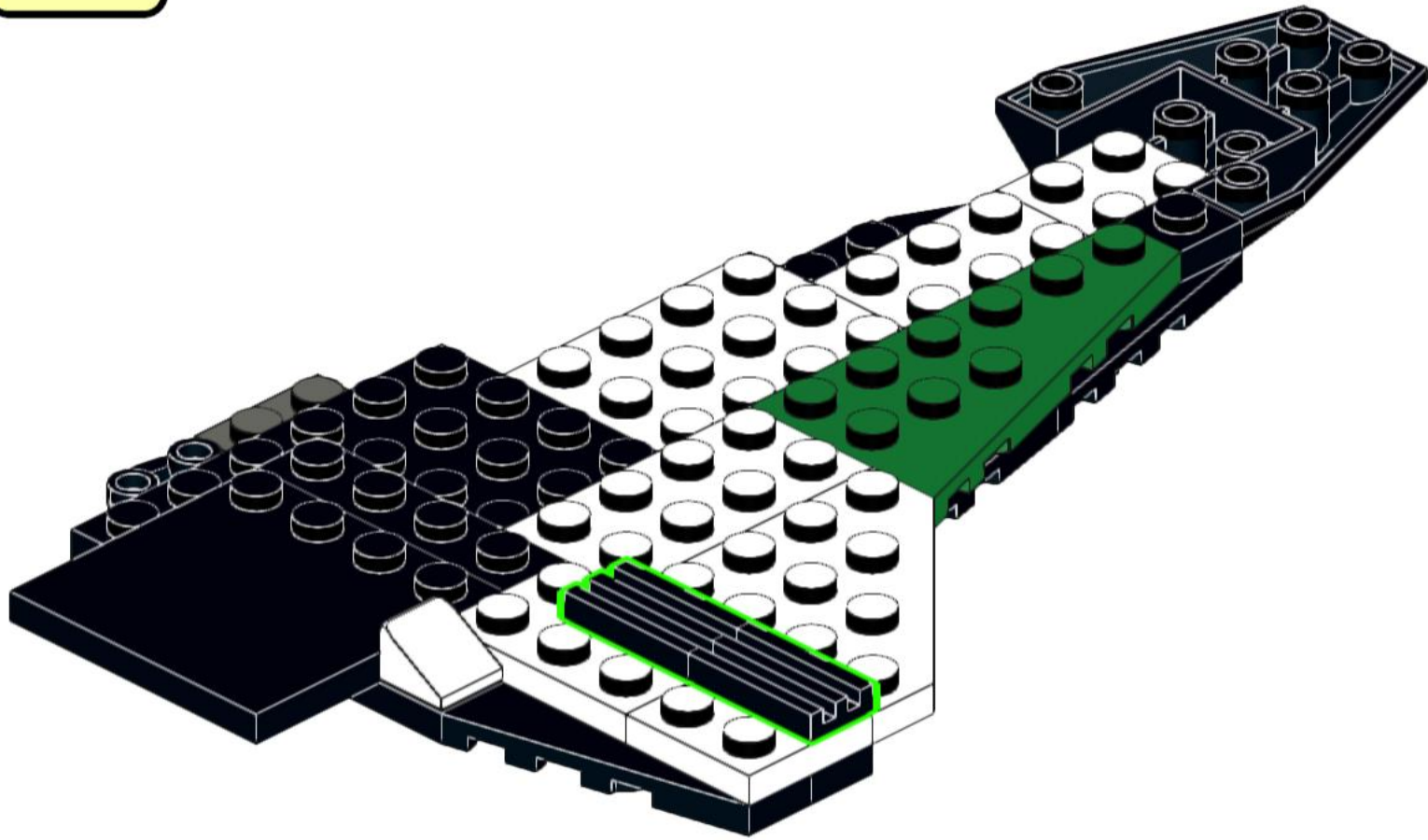

# 12

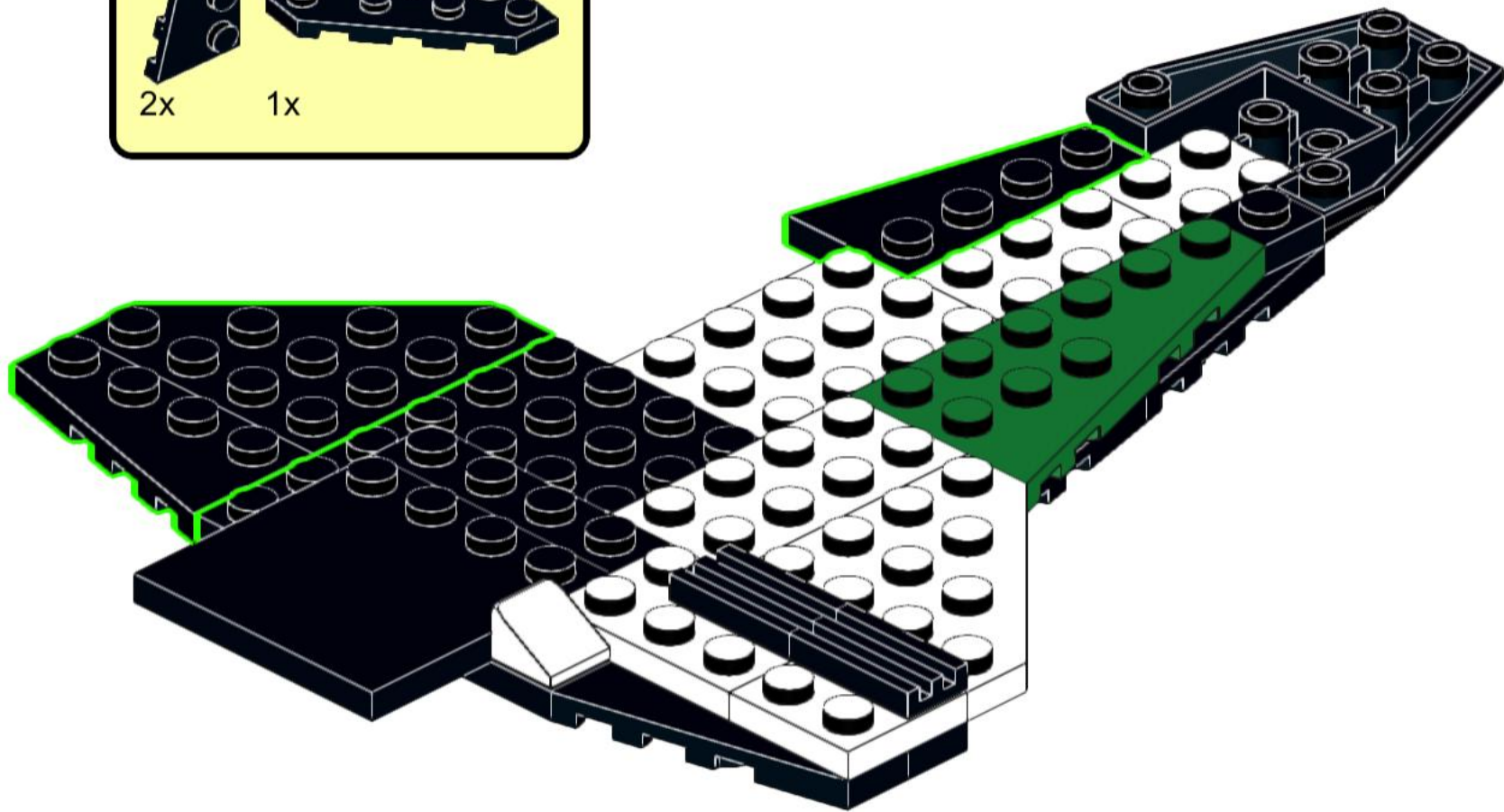
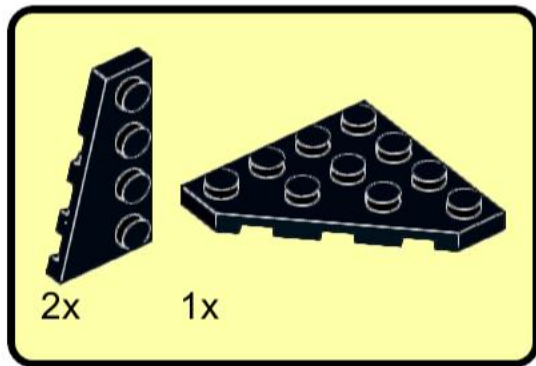



# 13

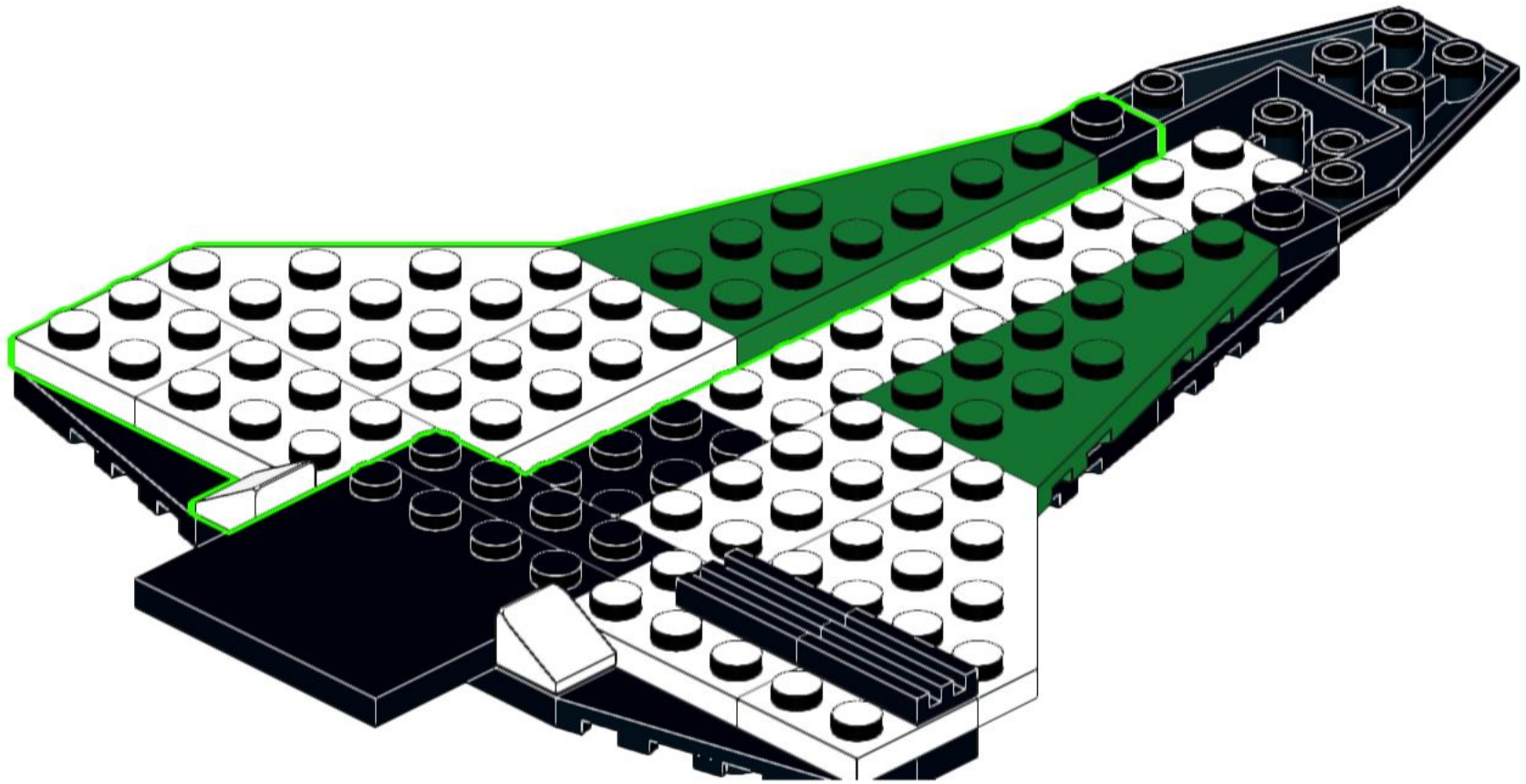
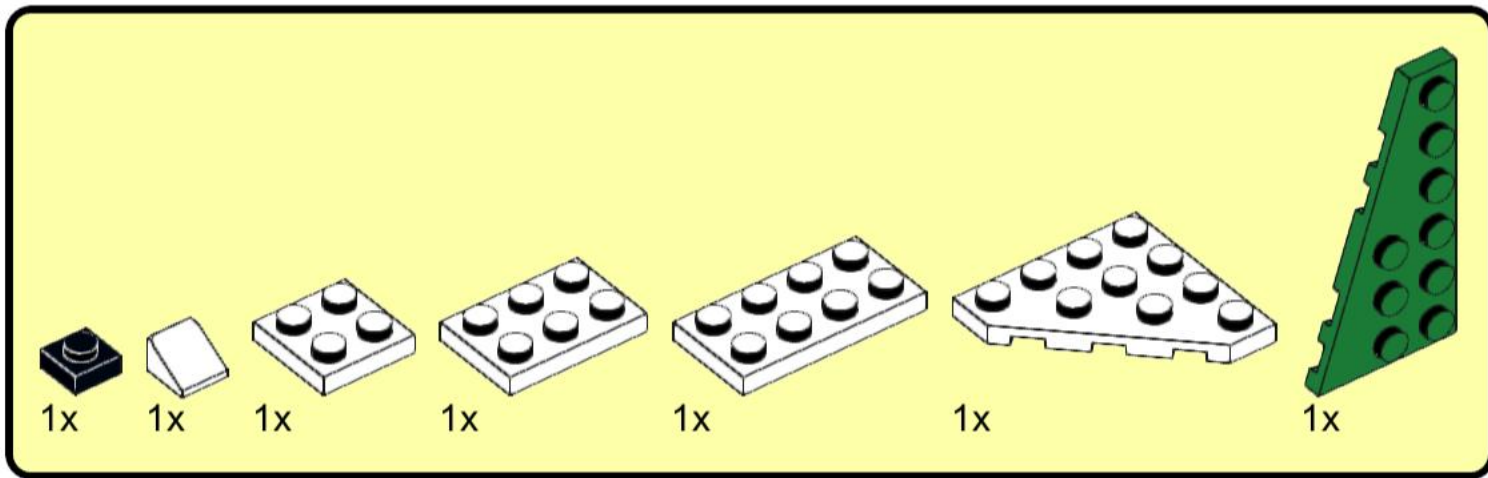

14

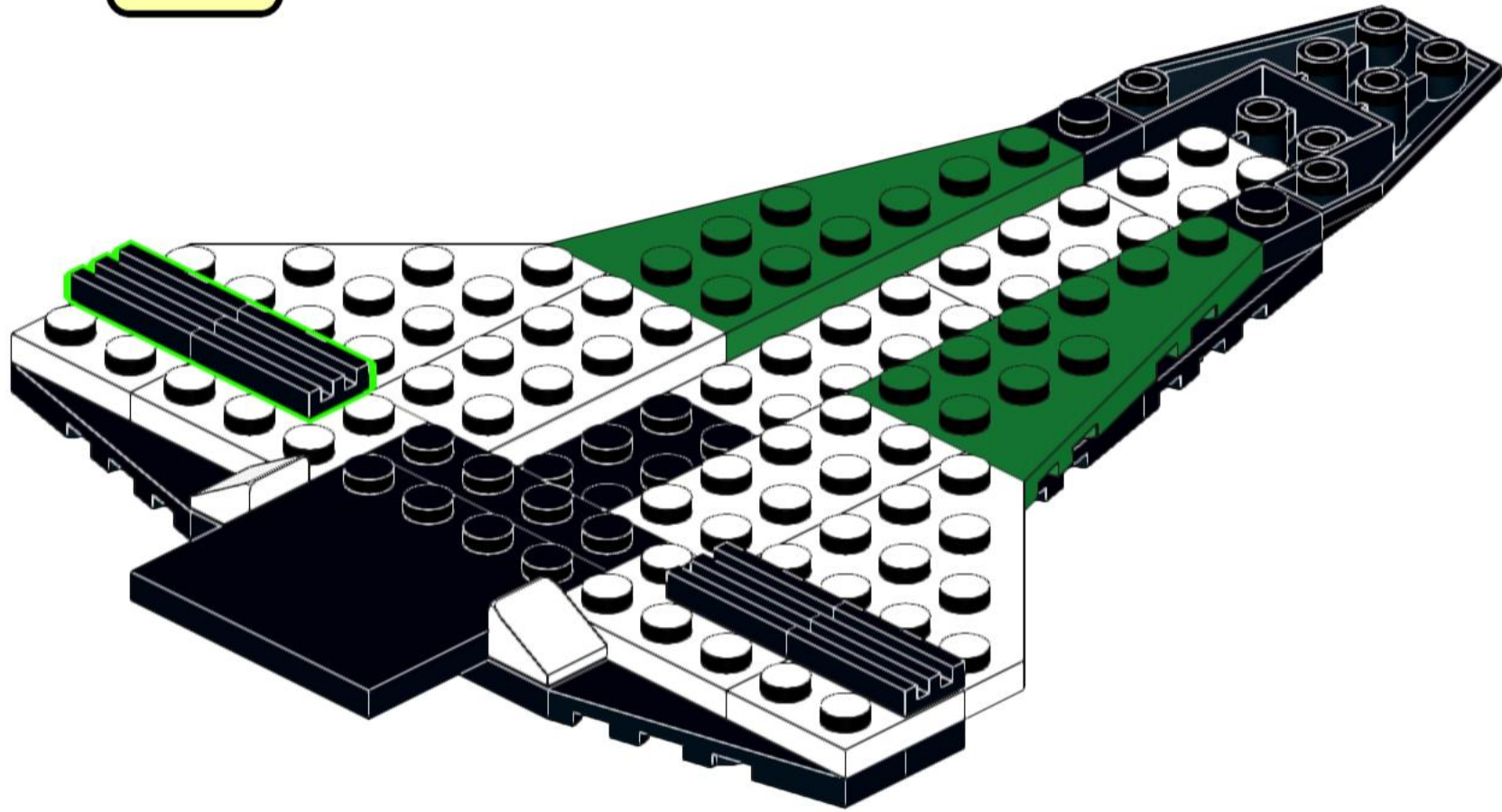



15

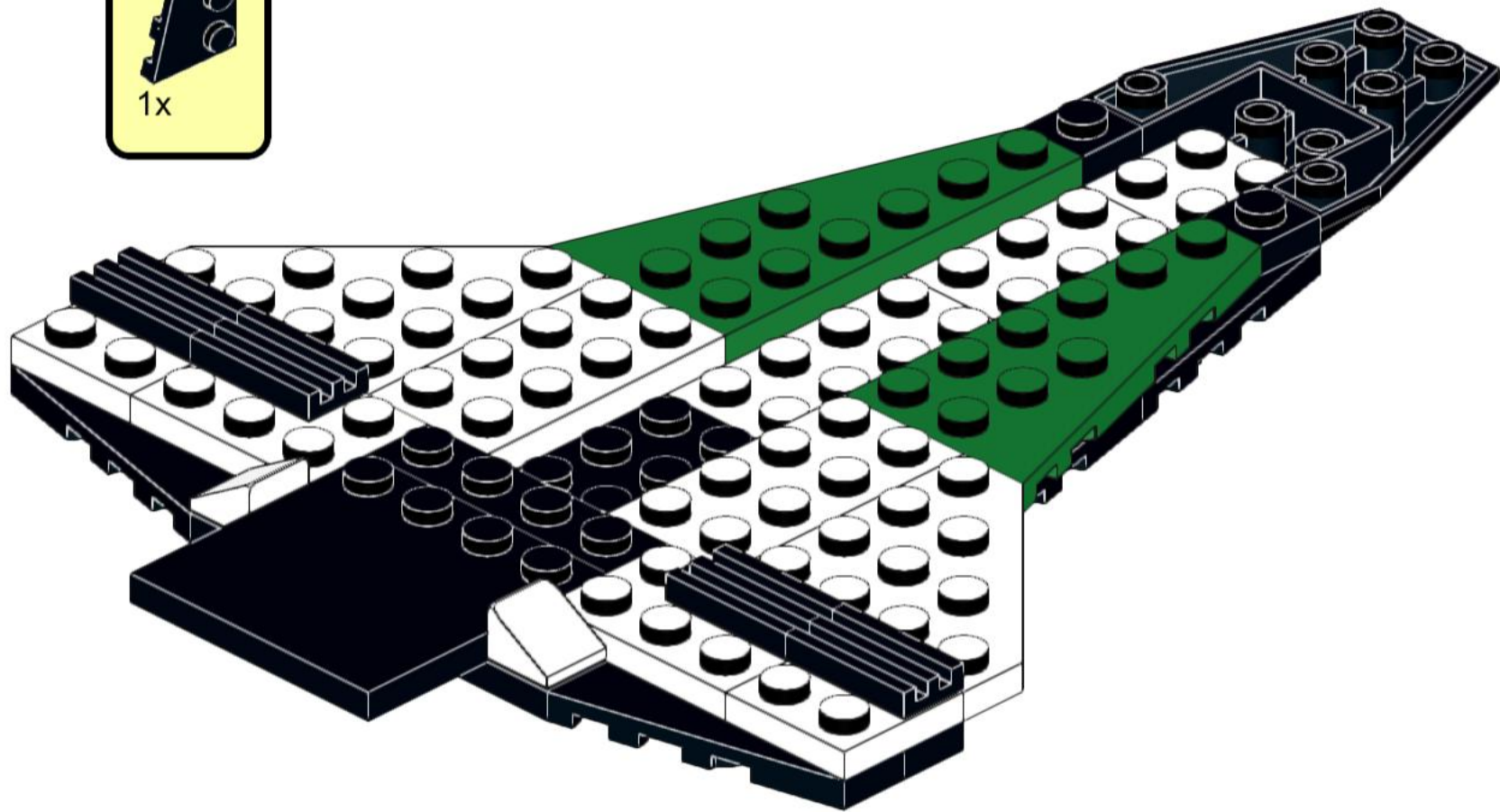

# 16

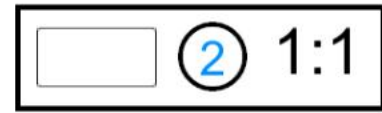
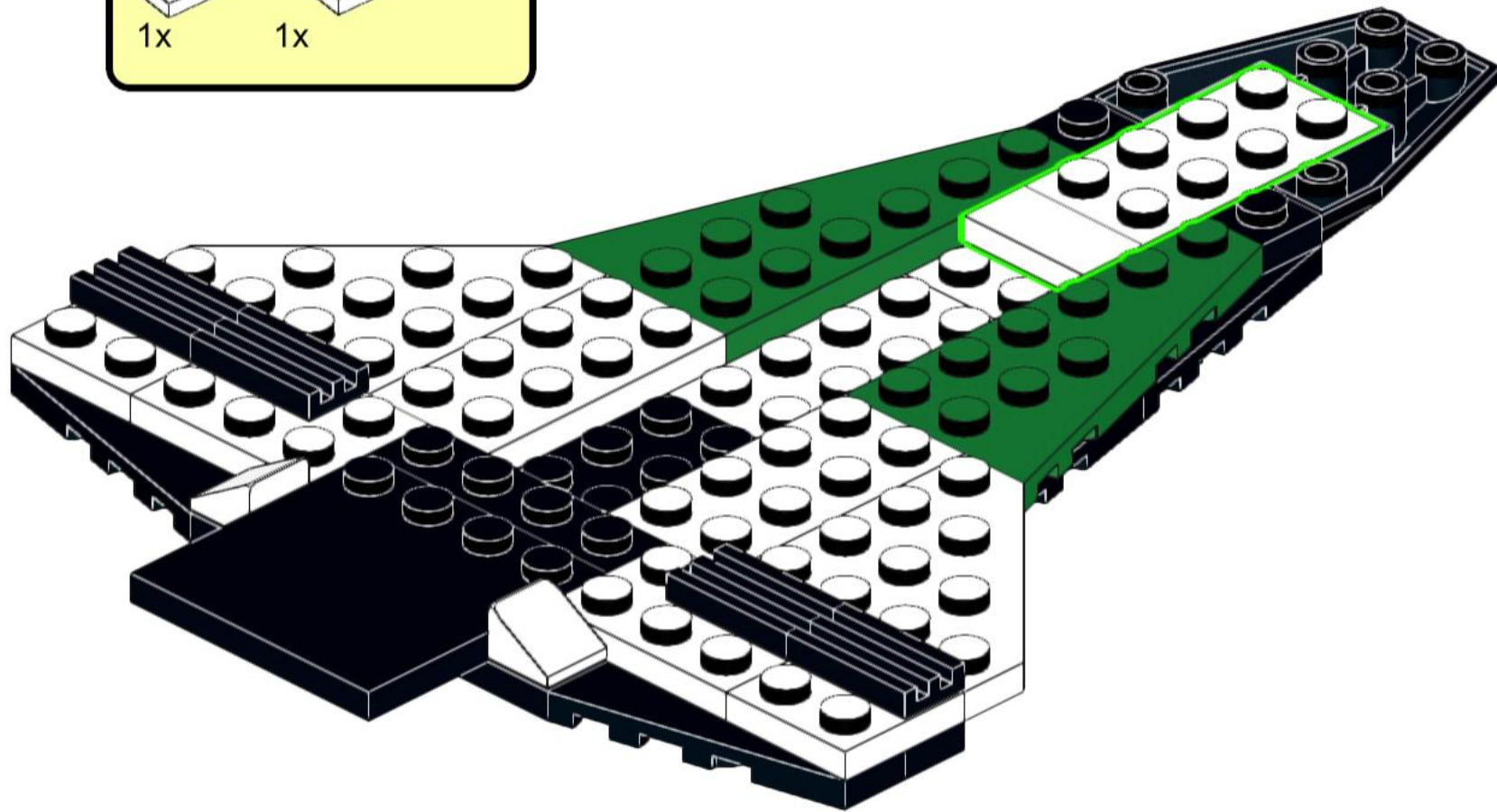
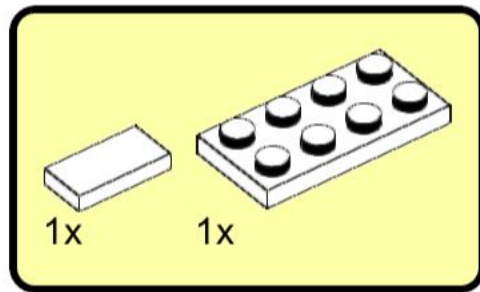

17

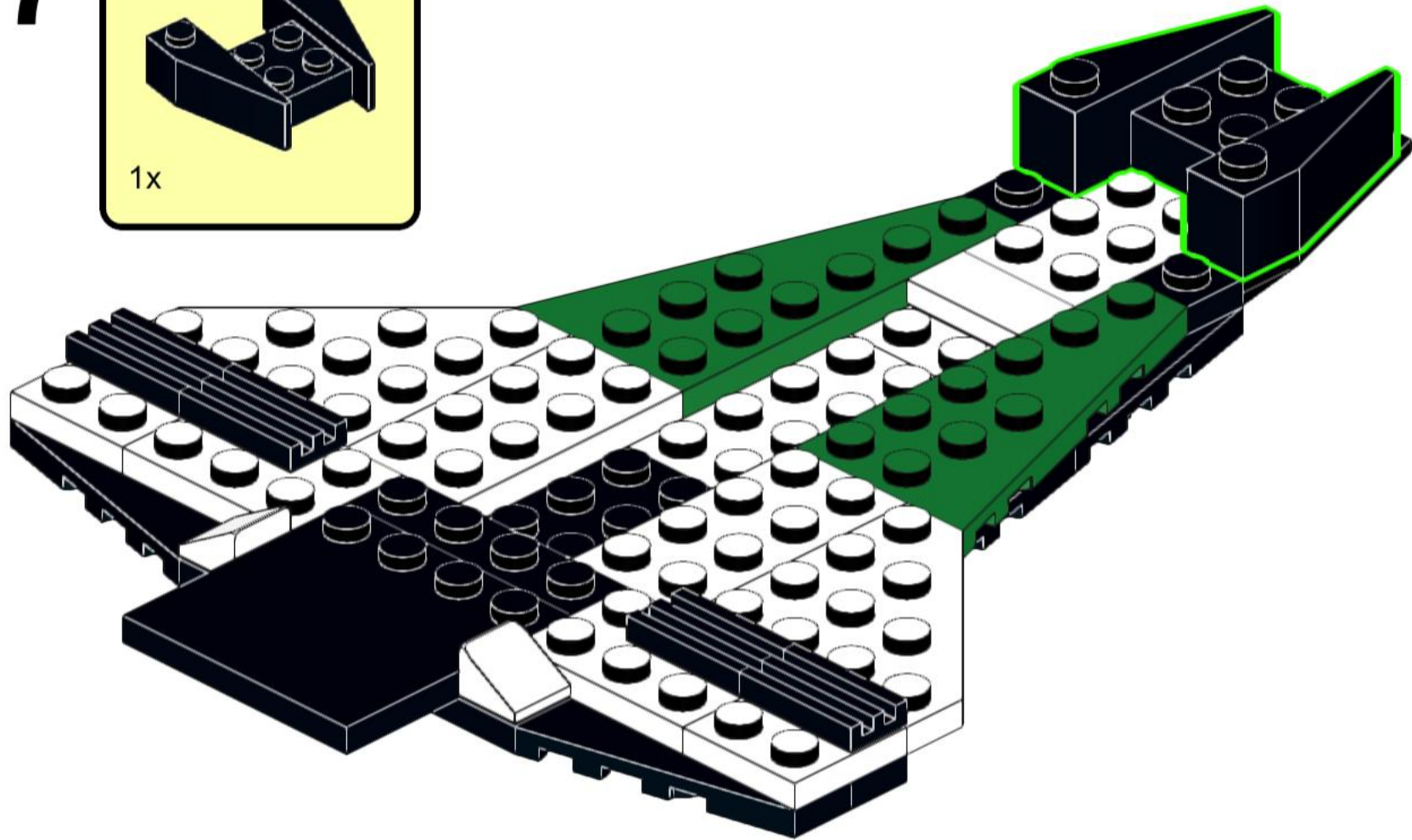
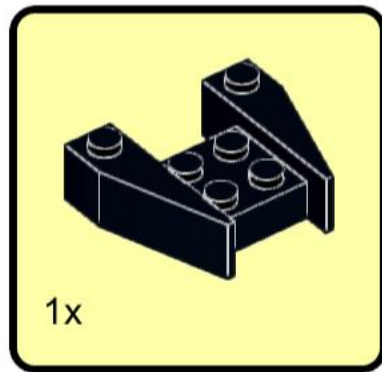



# 18

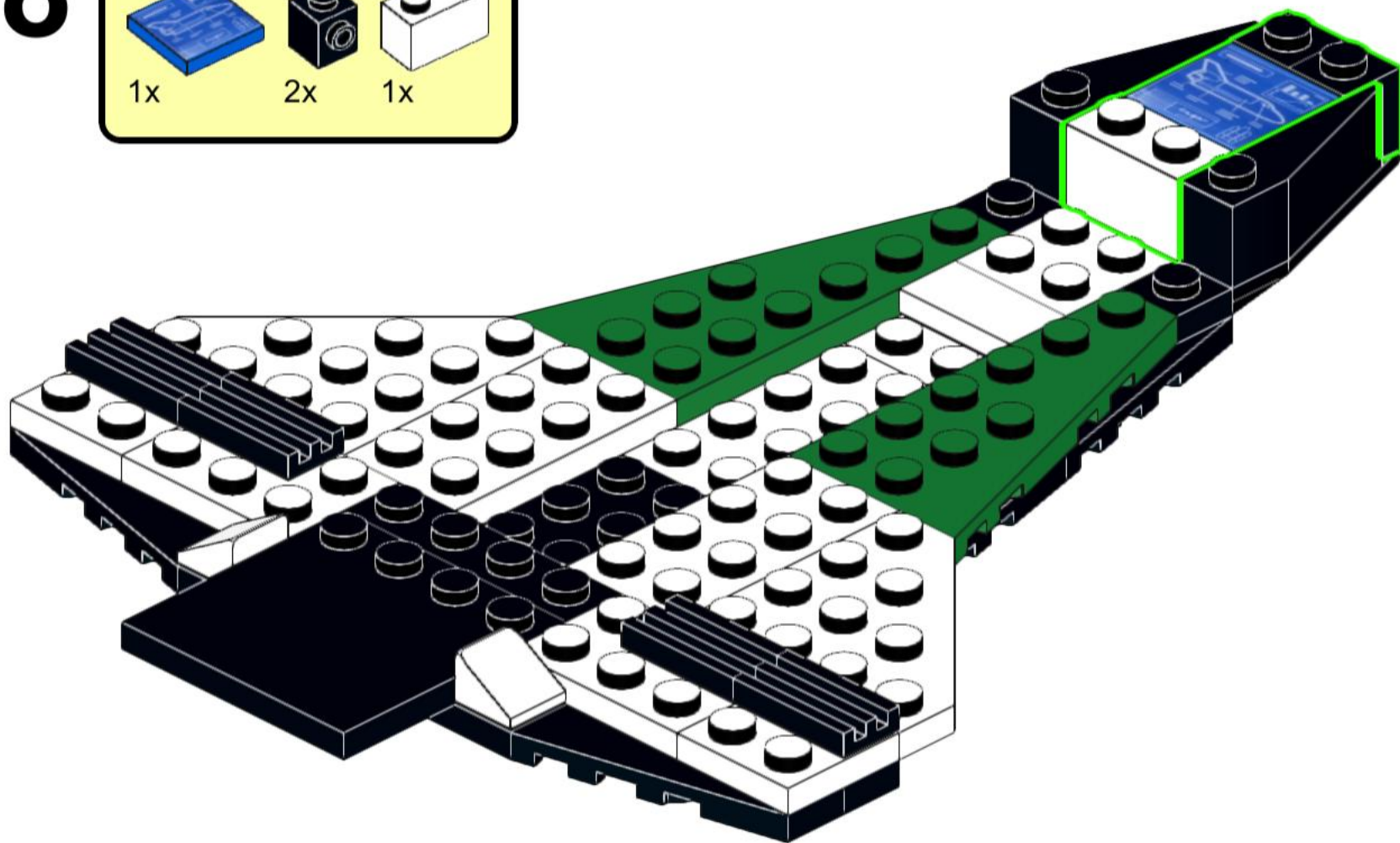
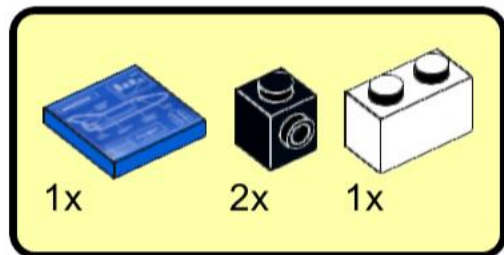

19

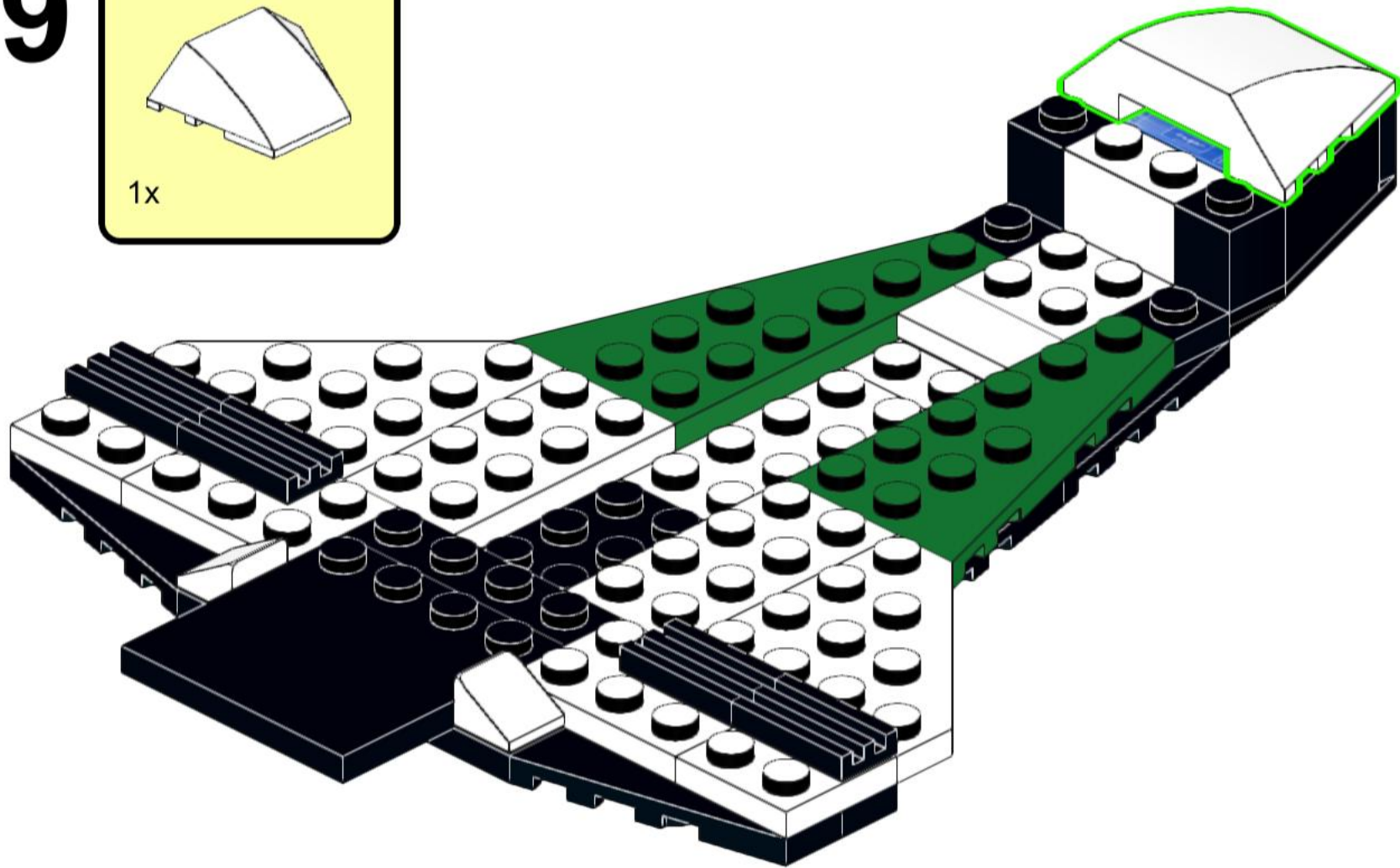
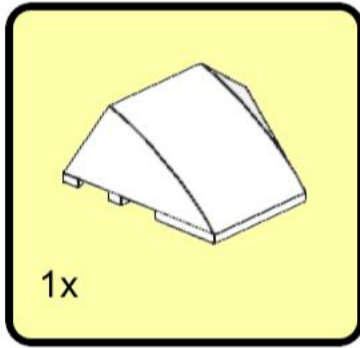

20

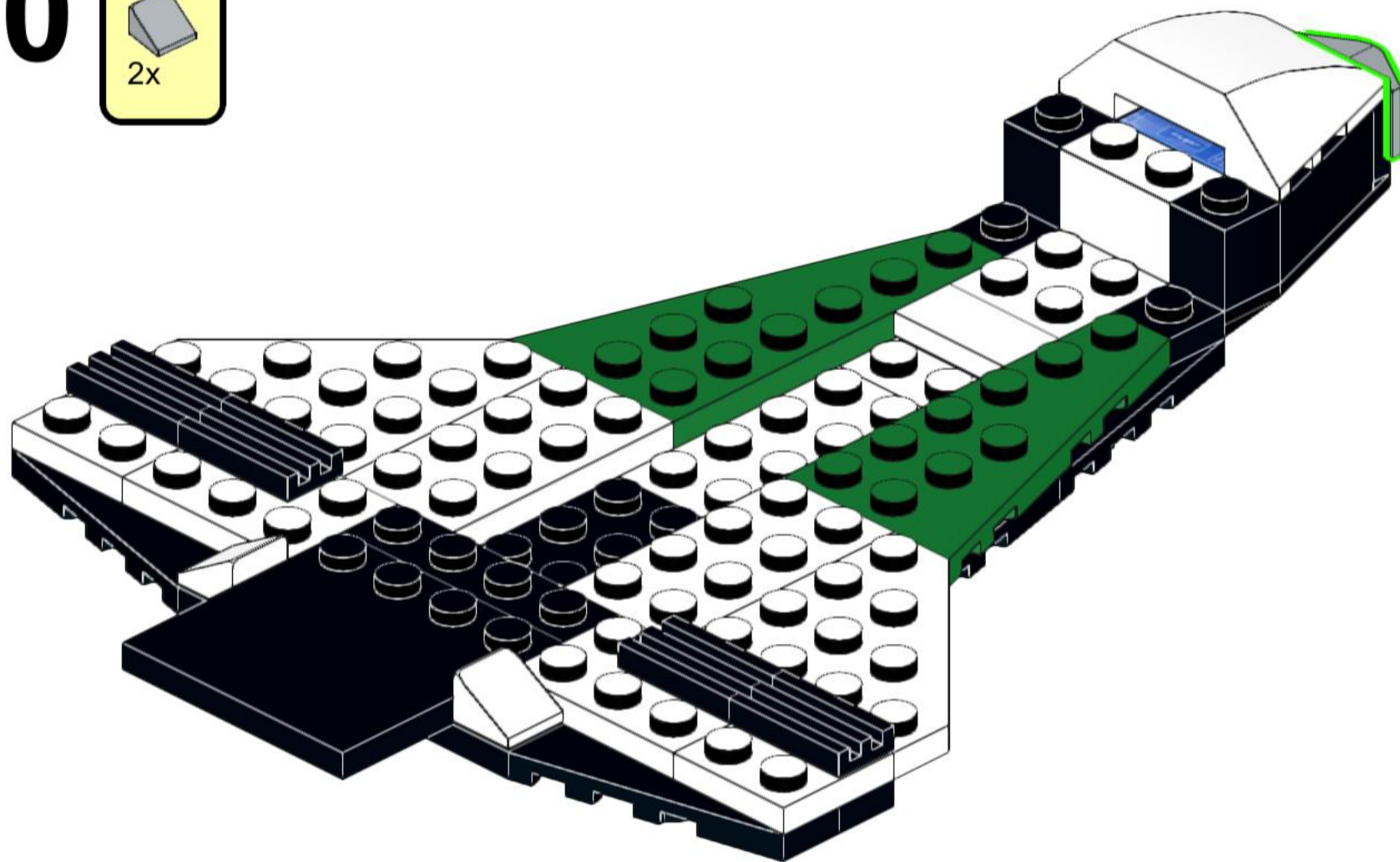
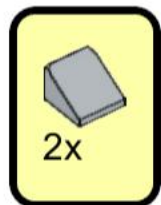



# 21

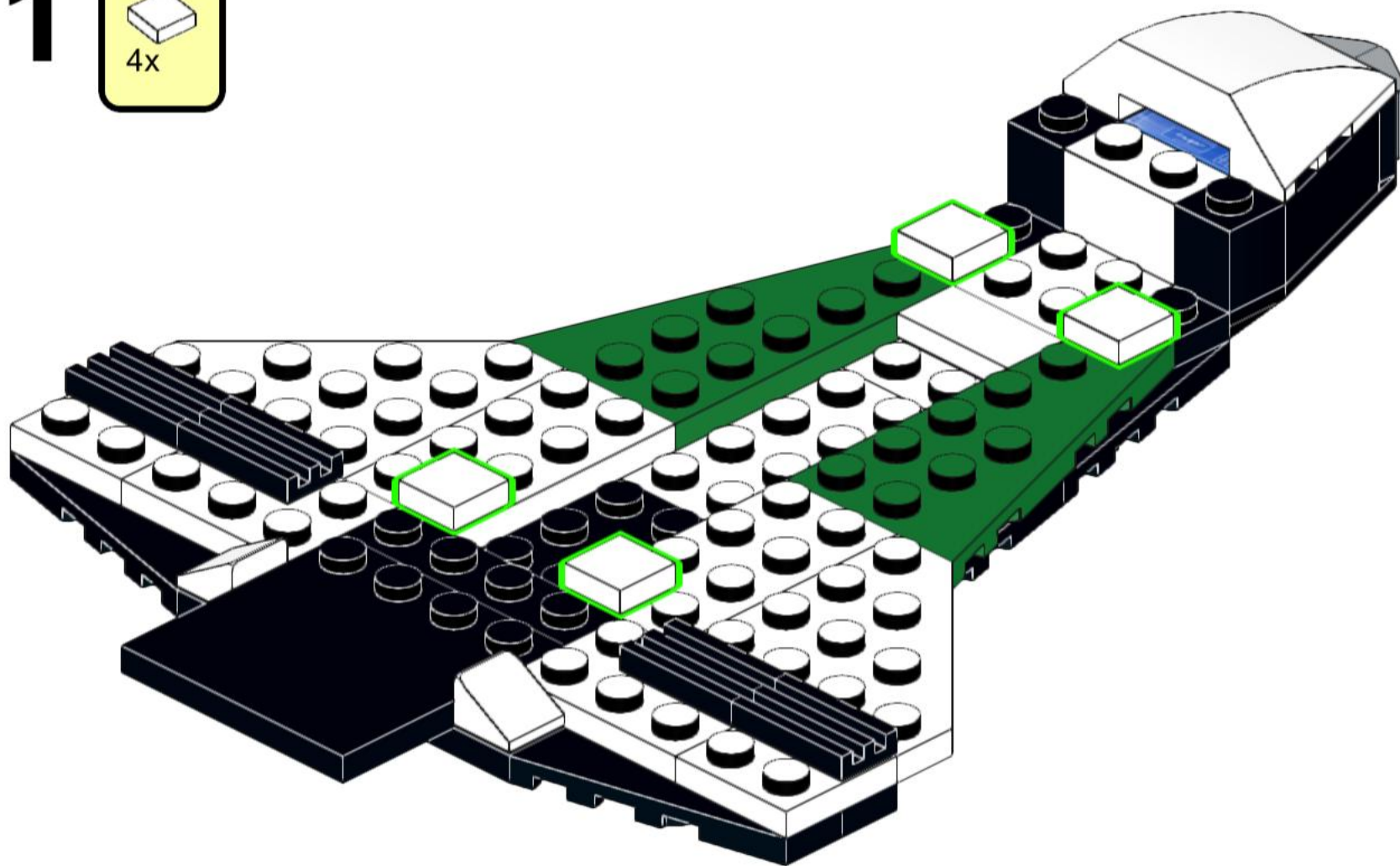
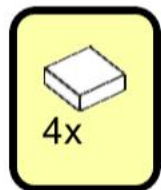

# 22

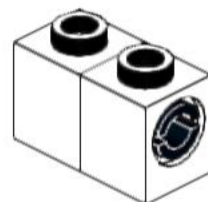
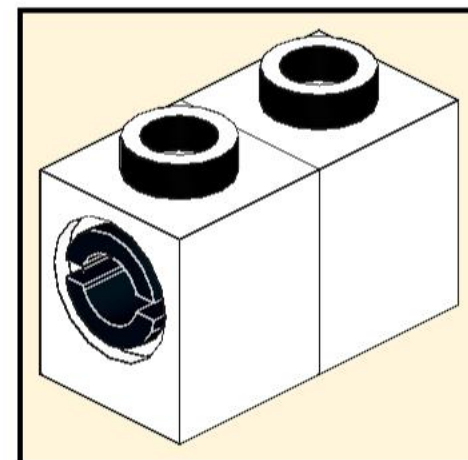
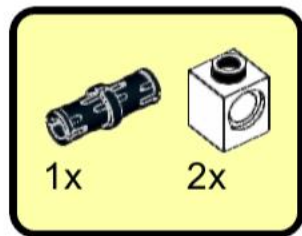

23

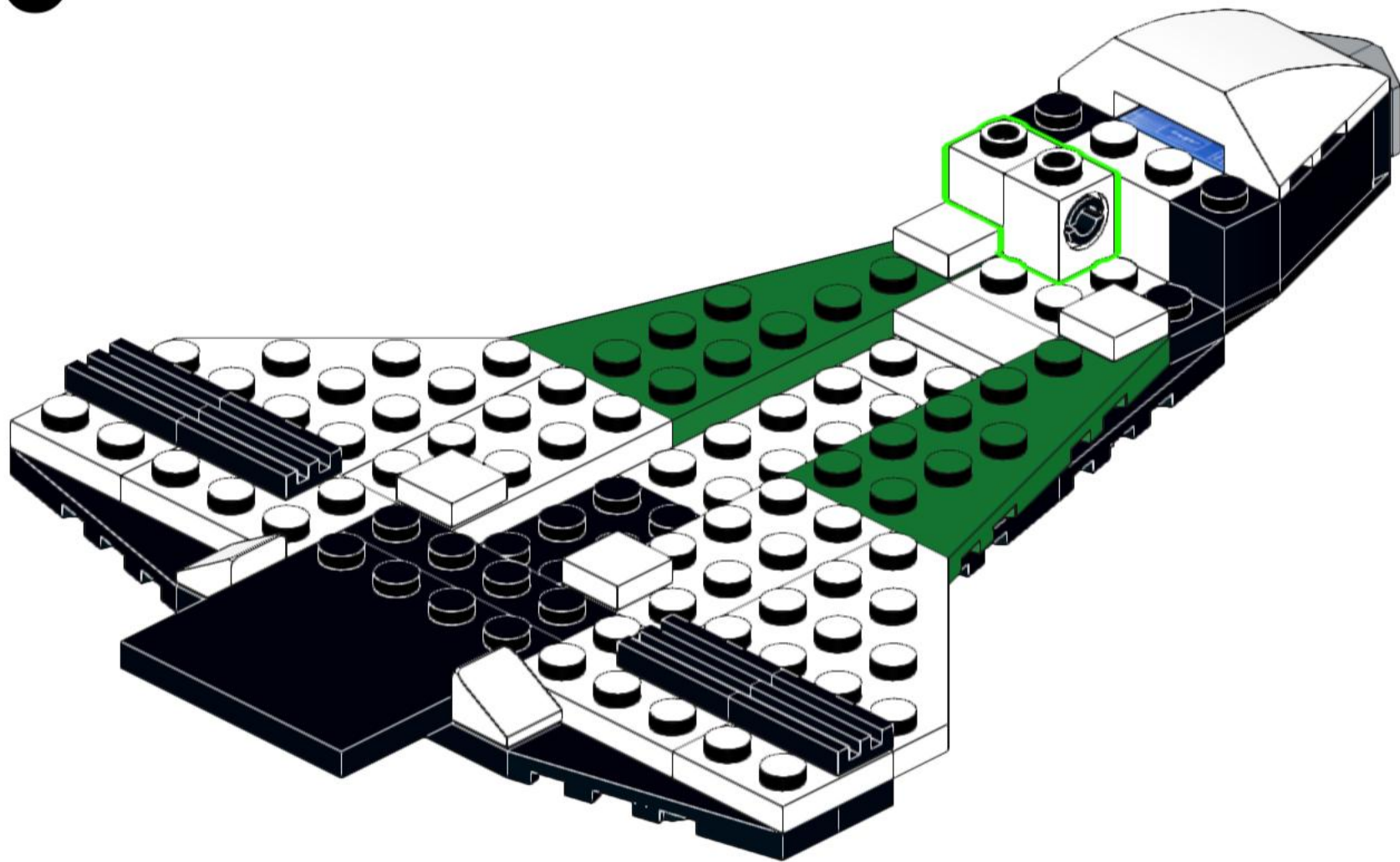

# 24

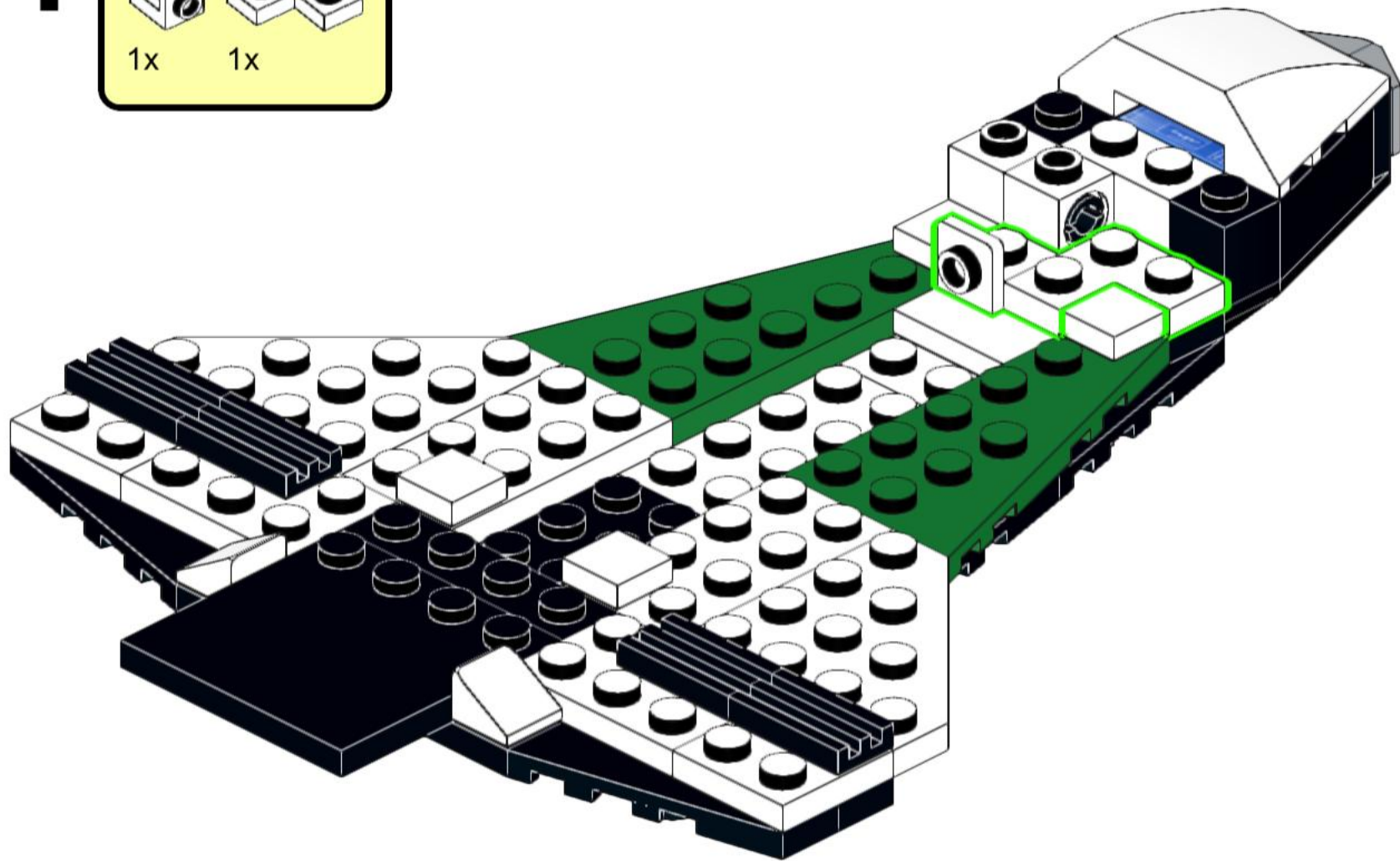
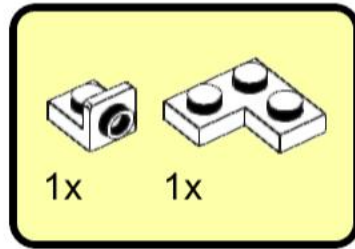



25

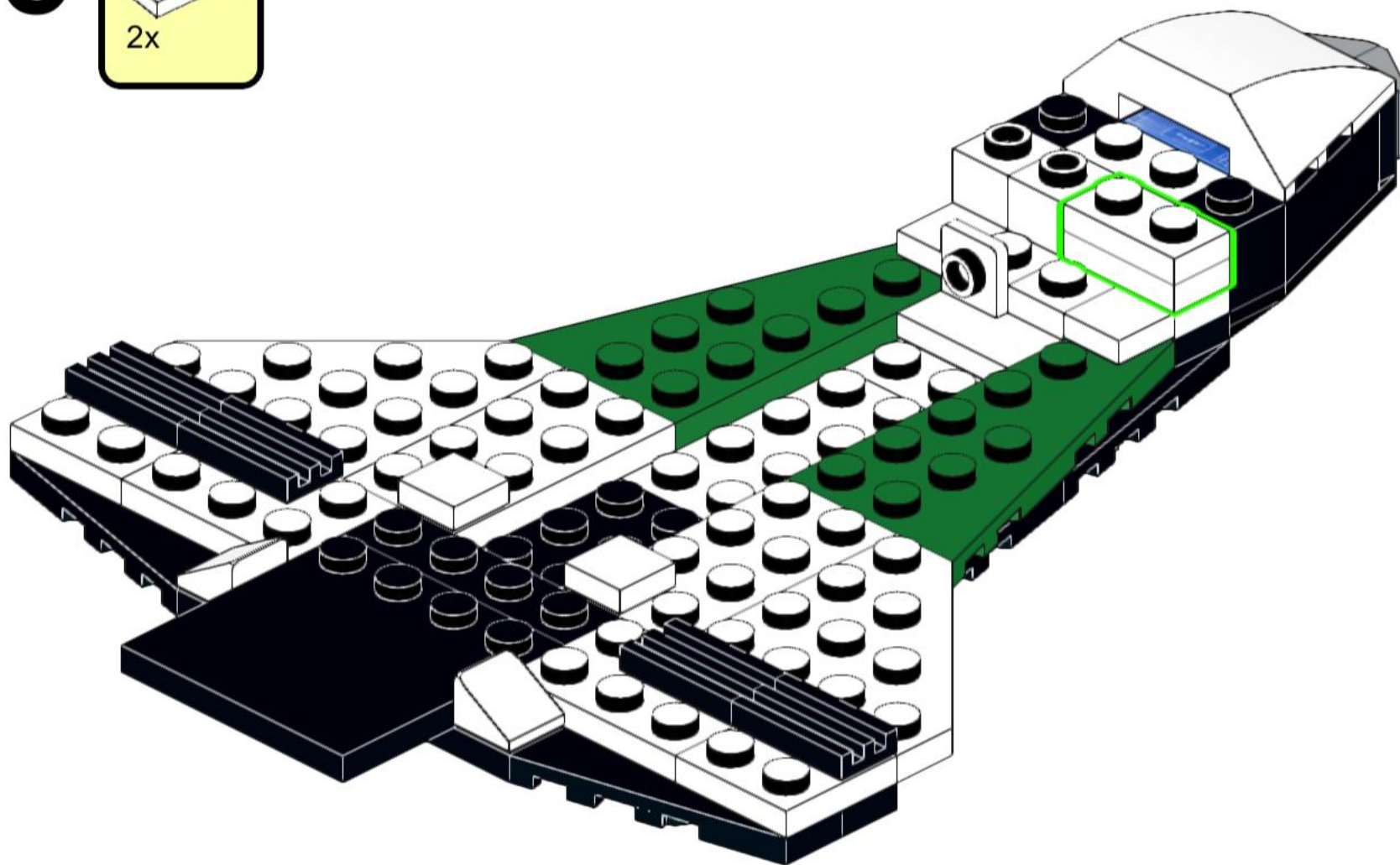
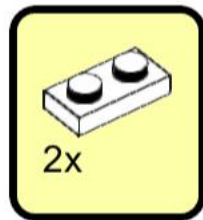

26

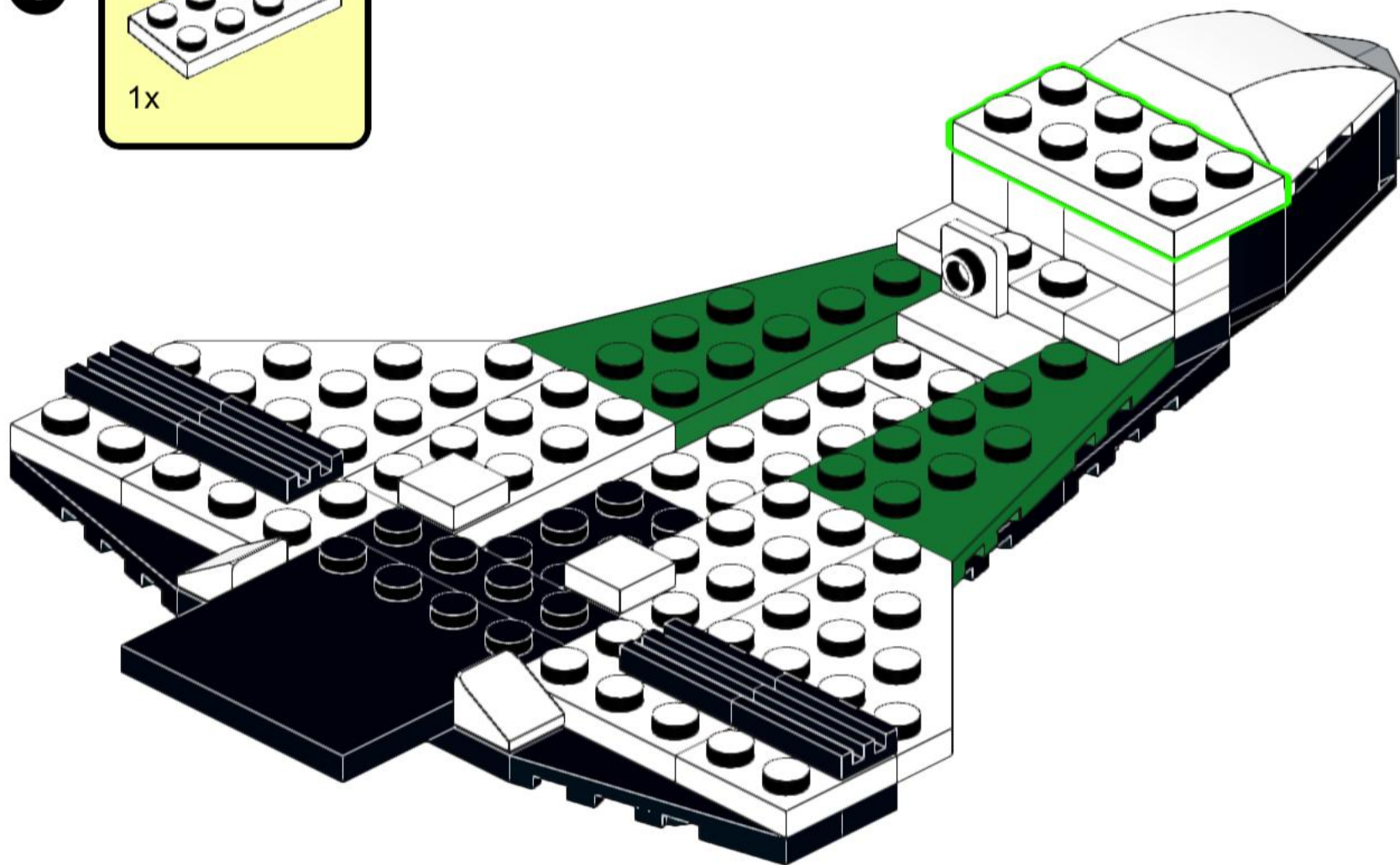
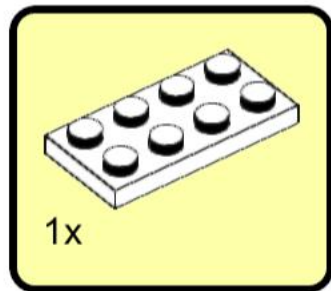

# 27

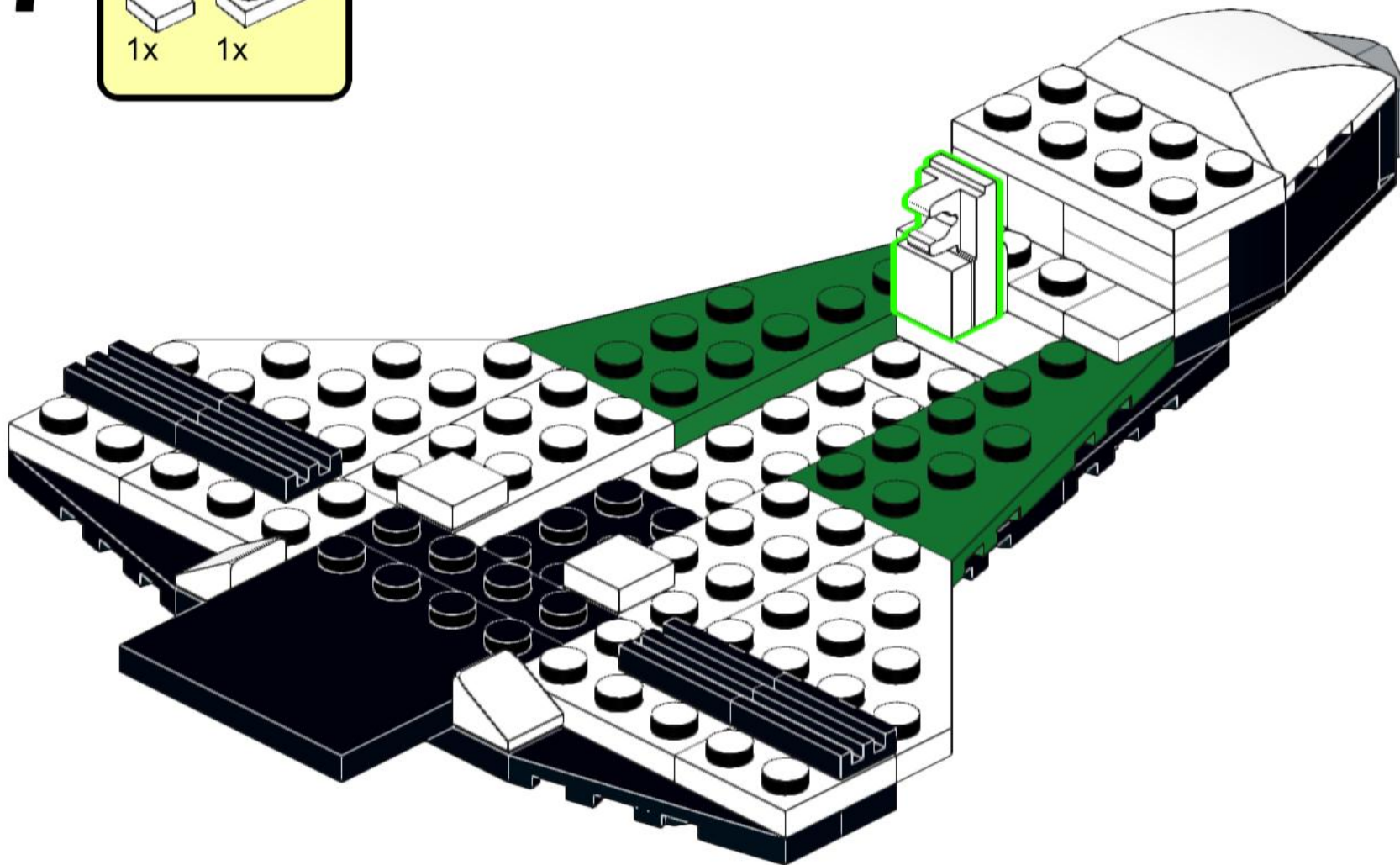
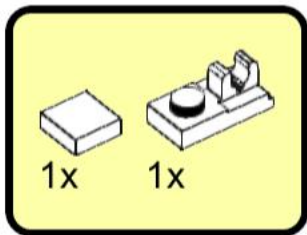



# 28

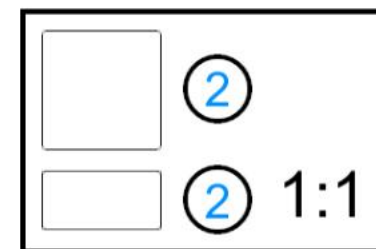
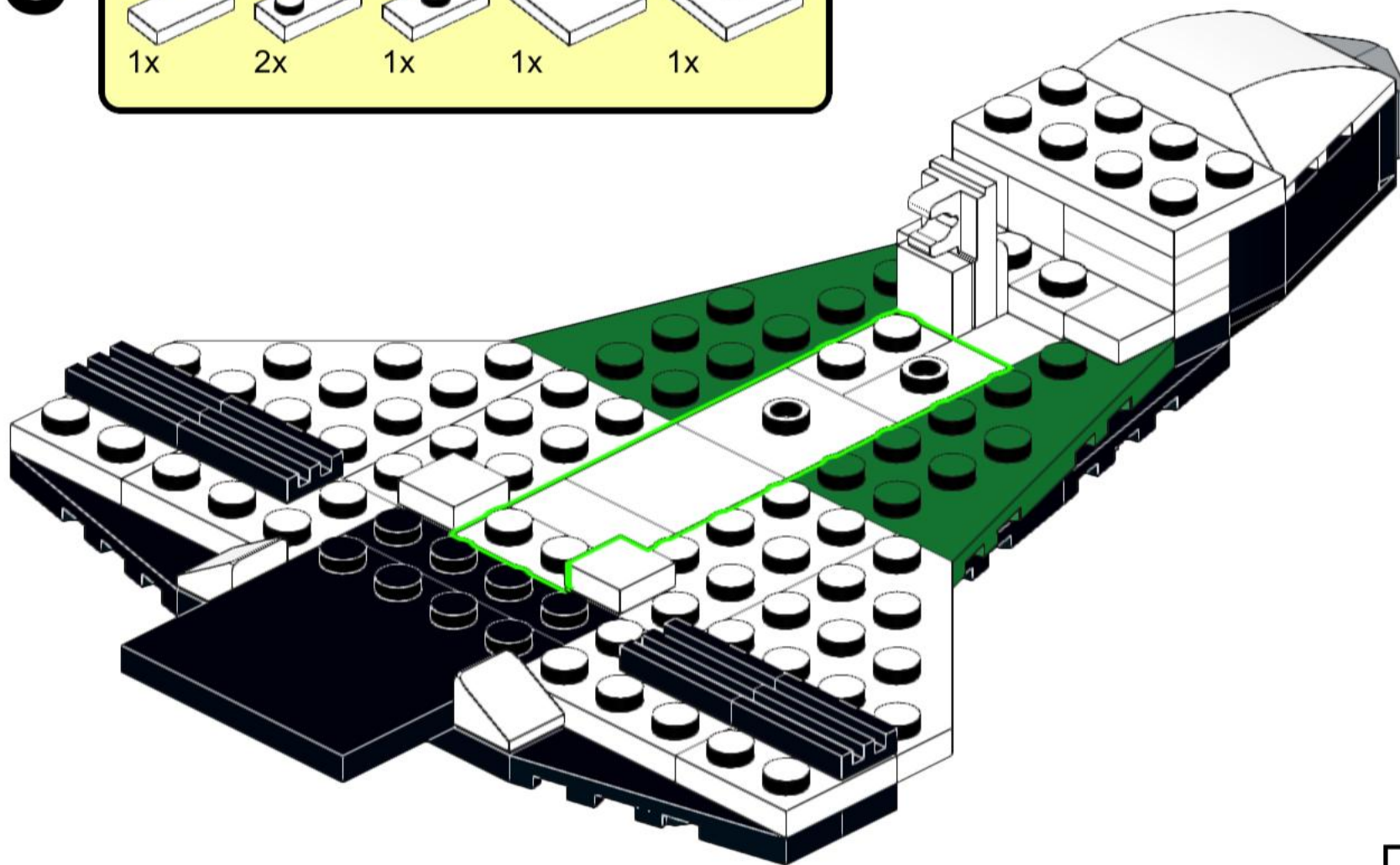
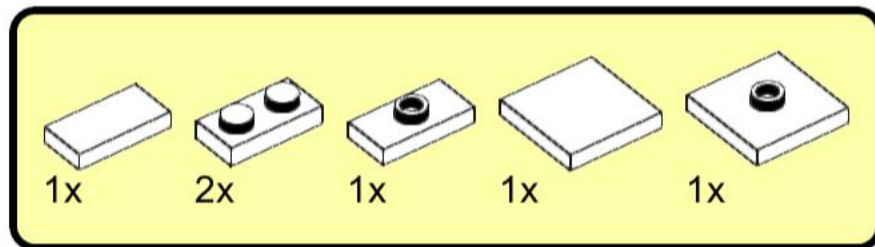



# 29

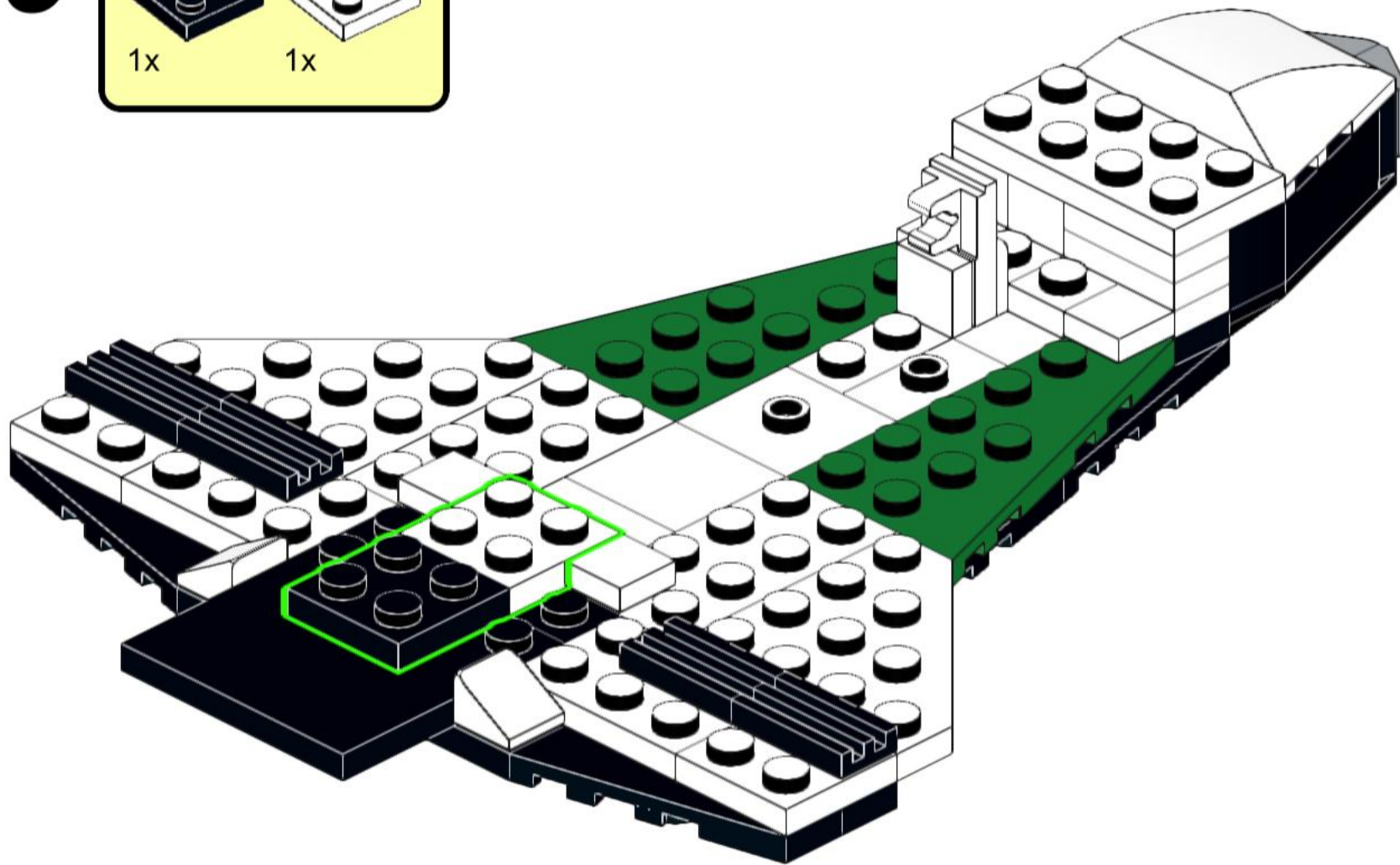
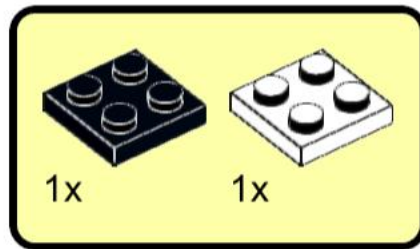

30

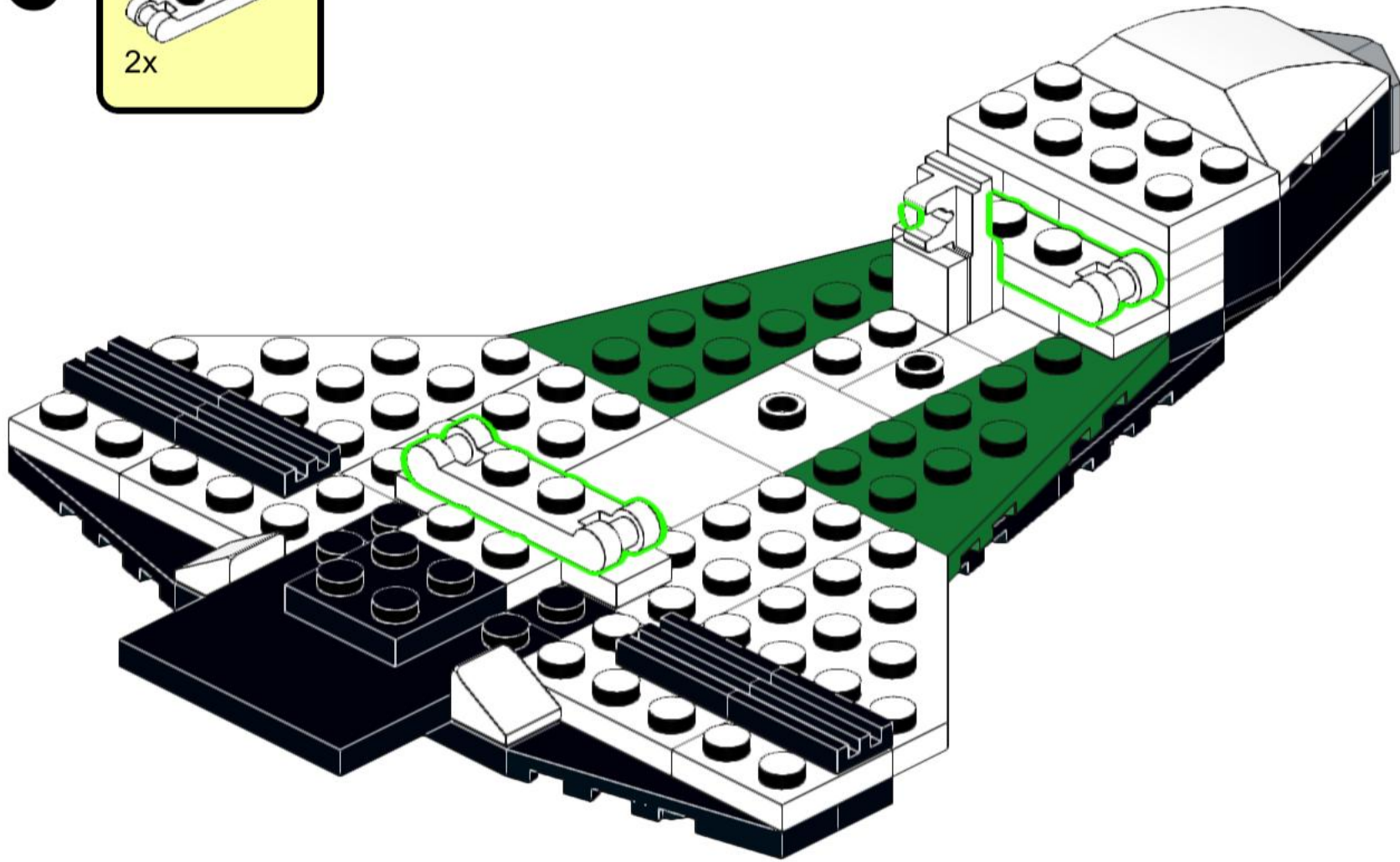
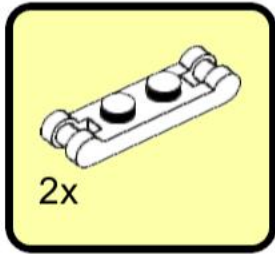

# 31

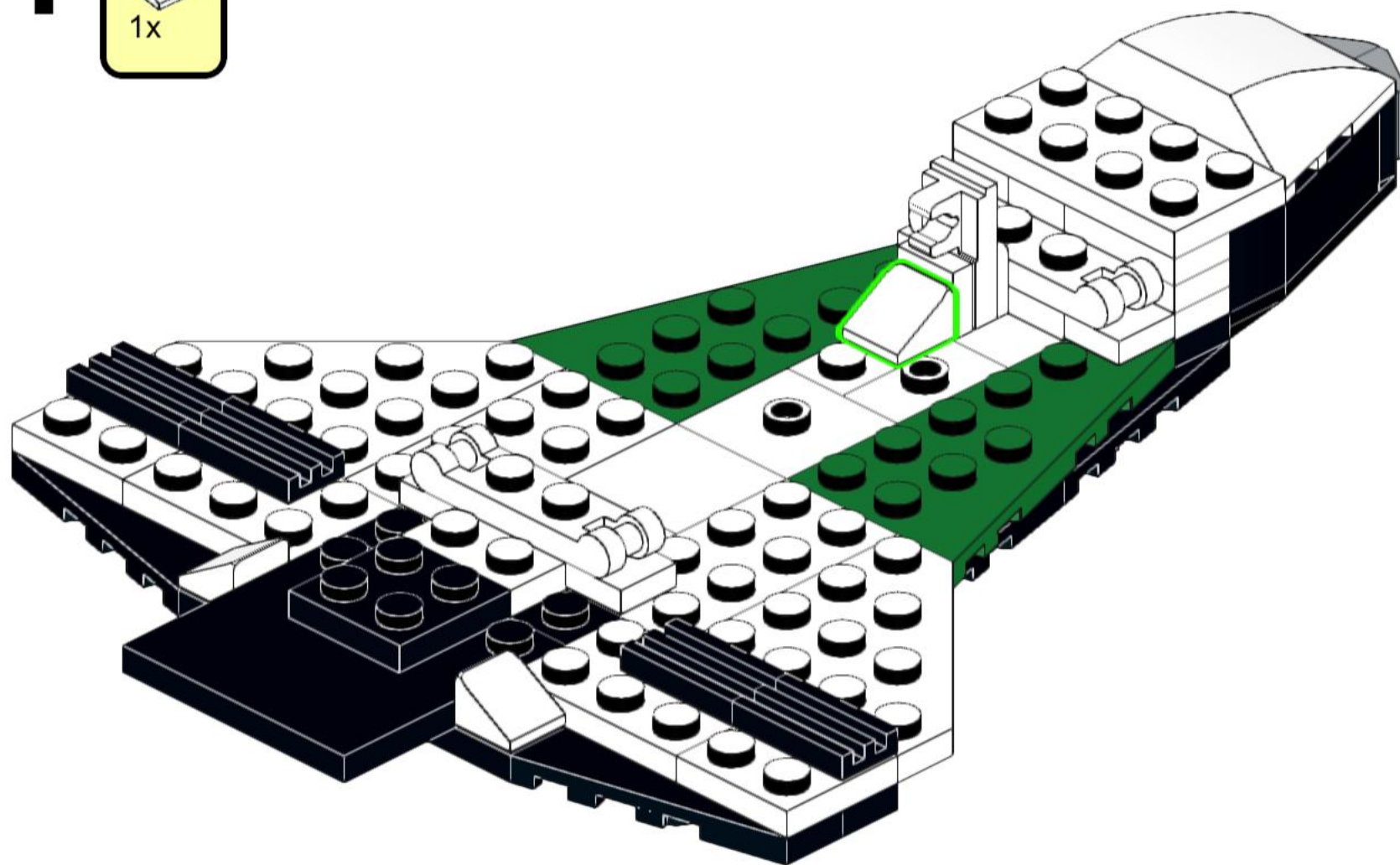
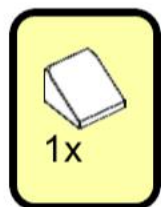







# 33

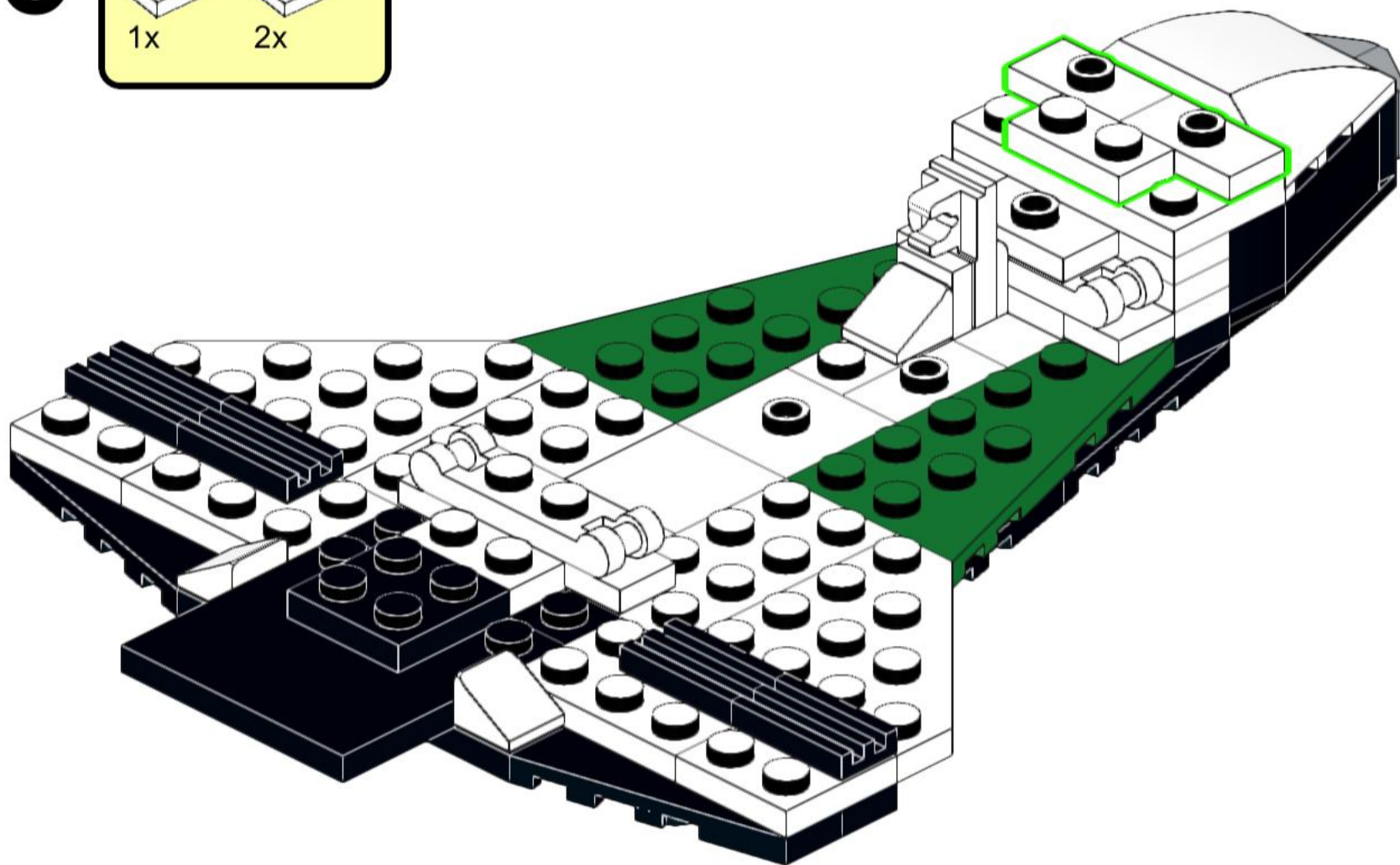
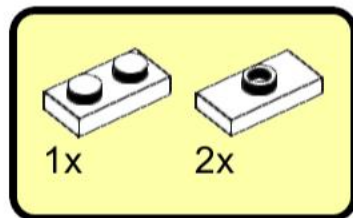

34

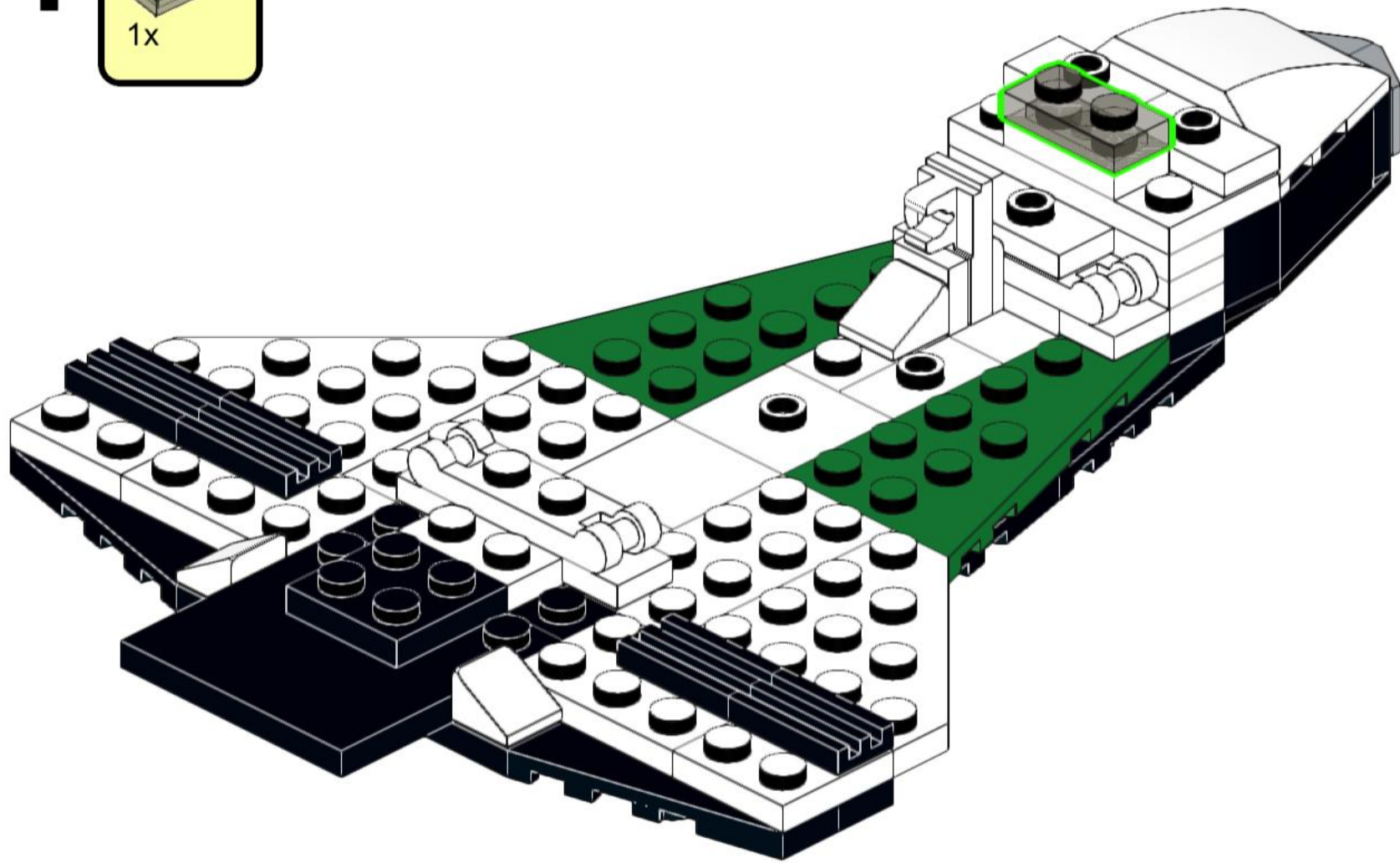
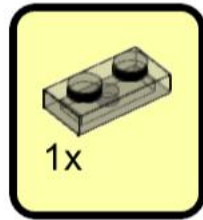

35

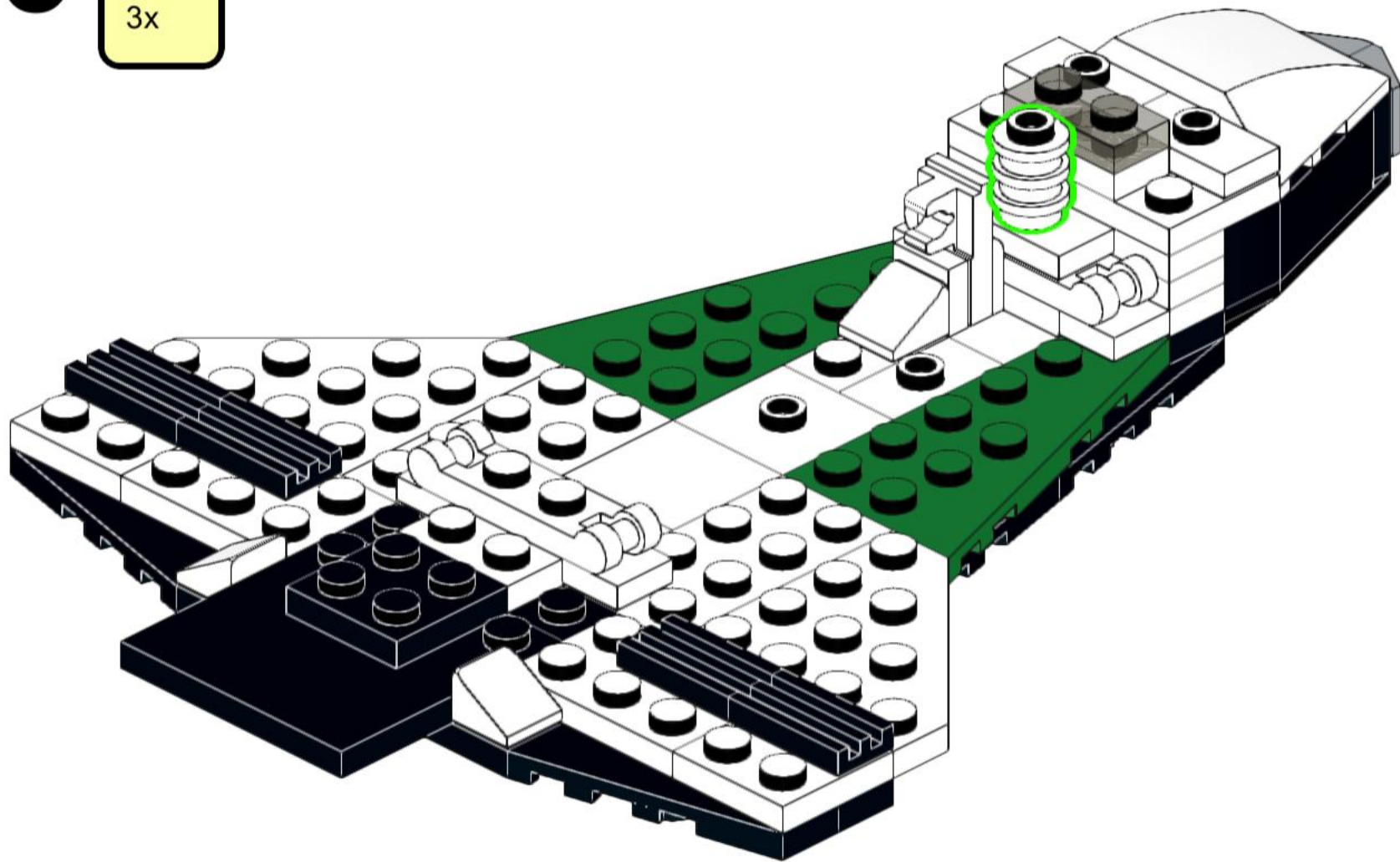
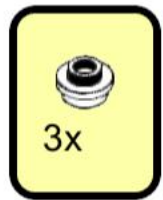



36

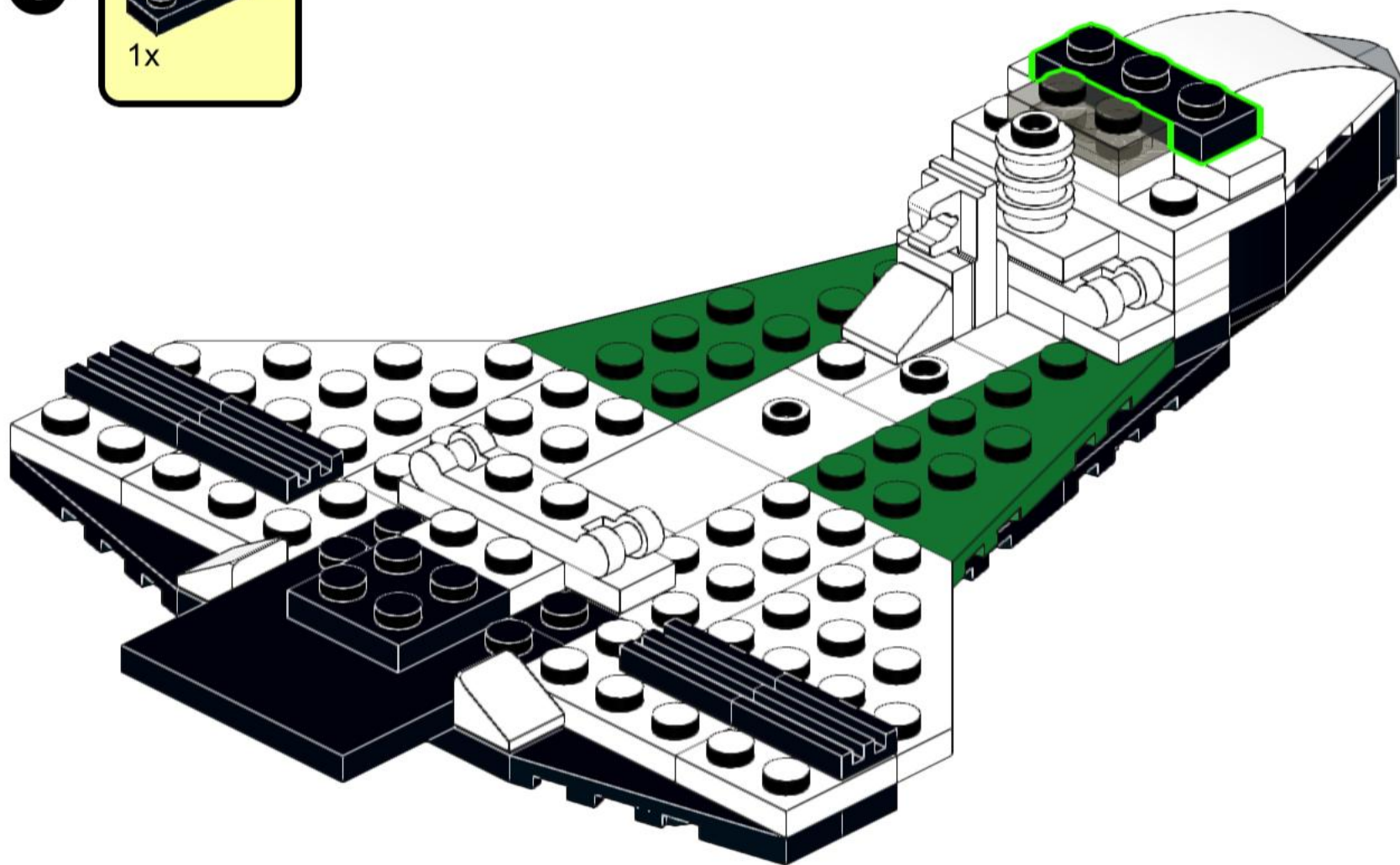
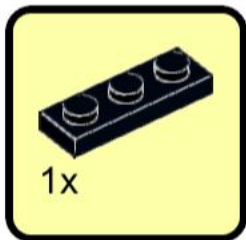





38

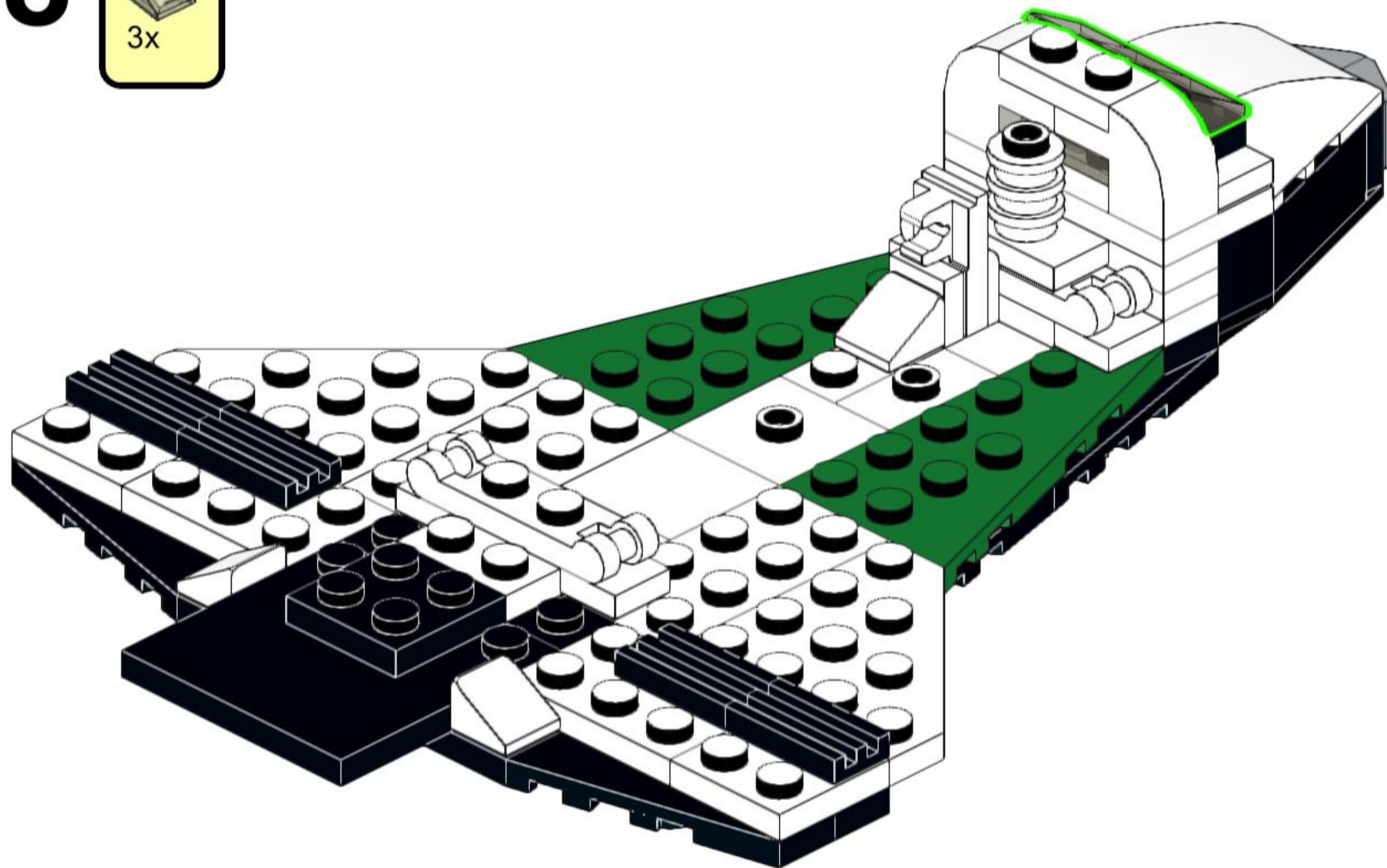
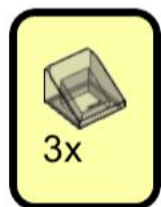

39

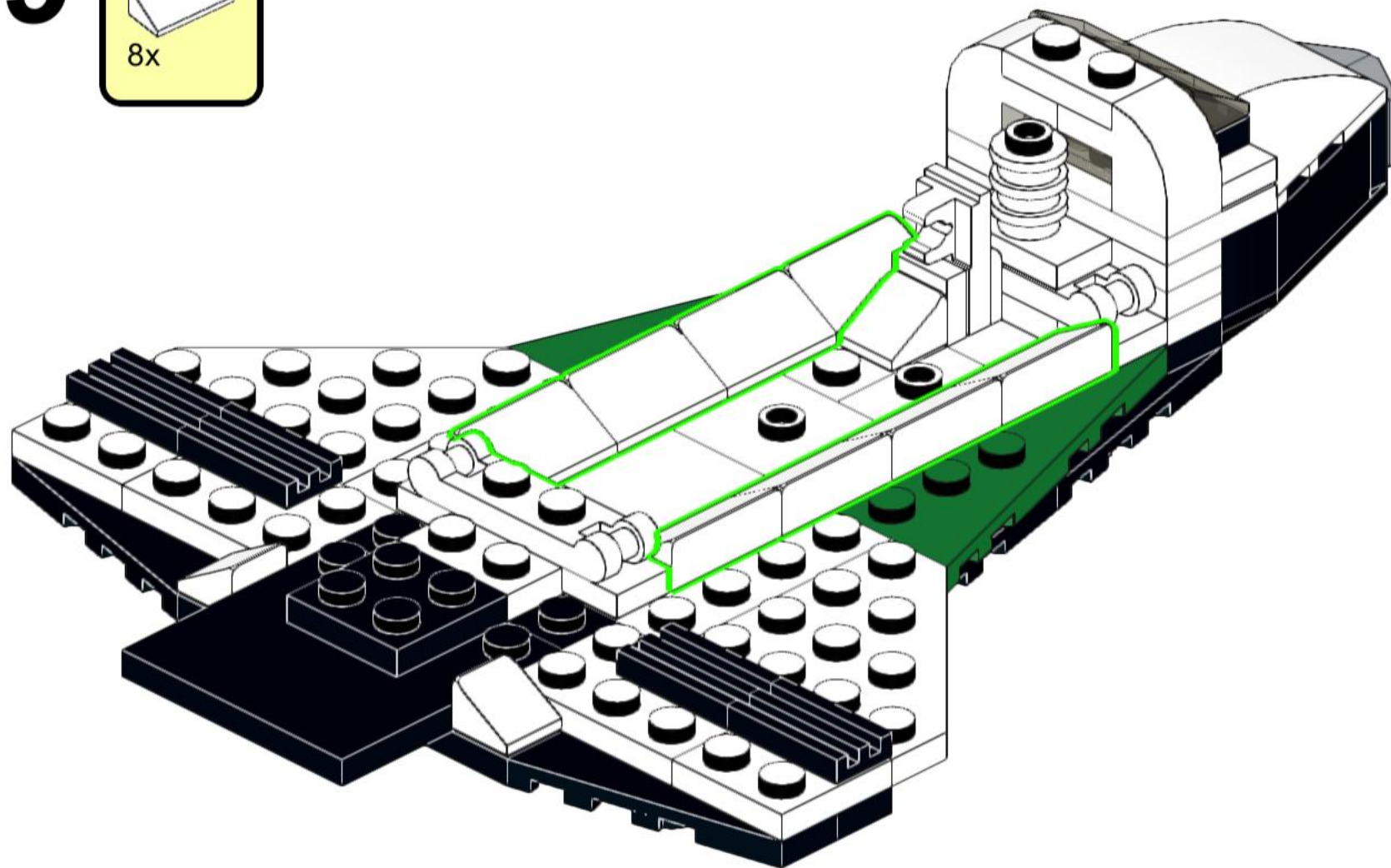
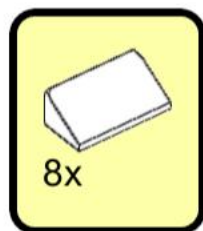



# 40

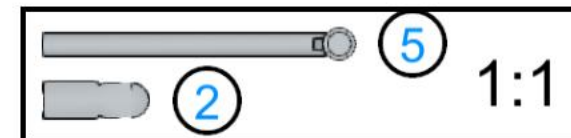
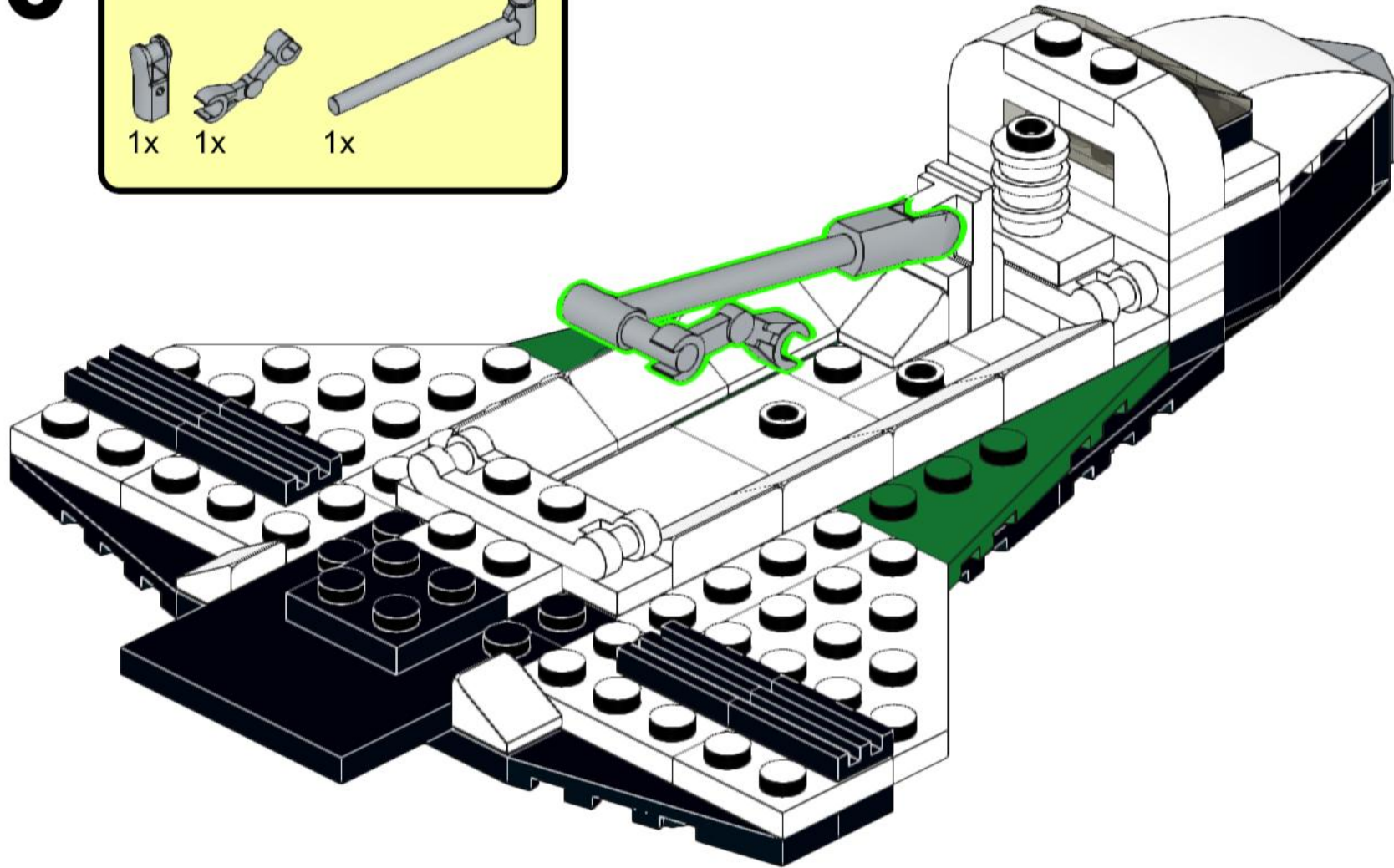
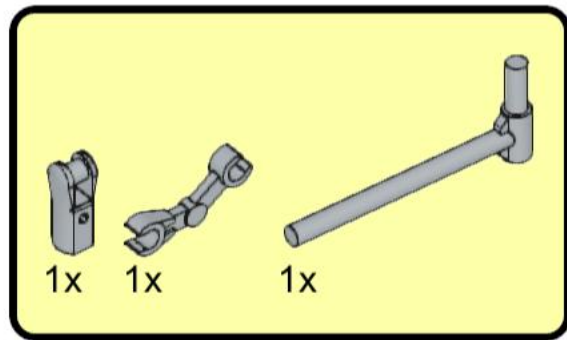



41

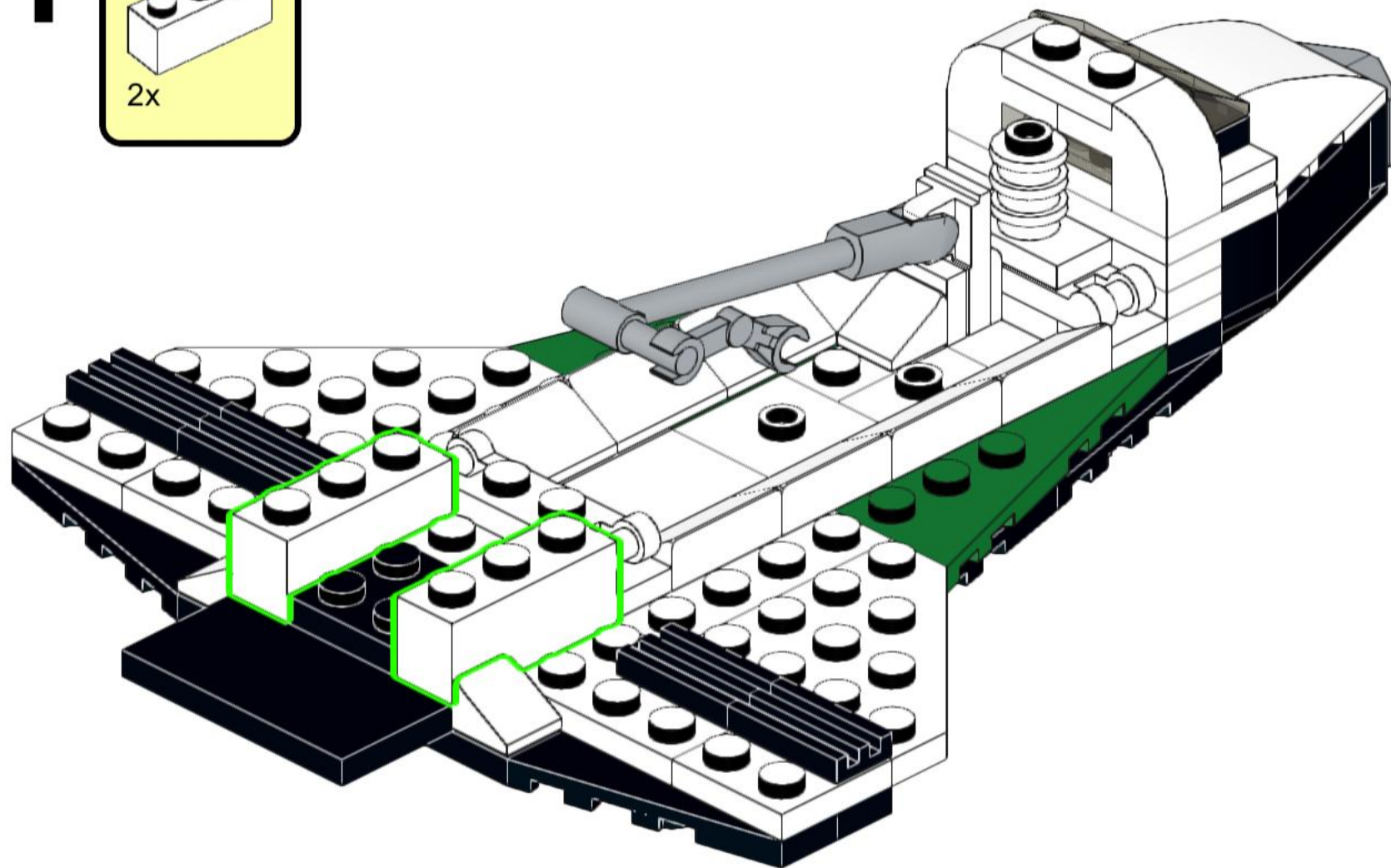
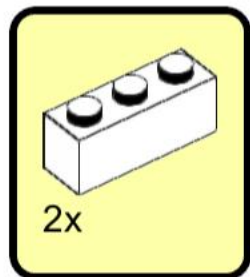

# 42

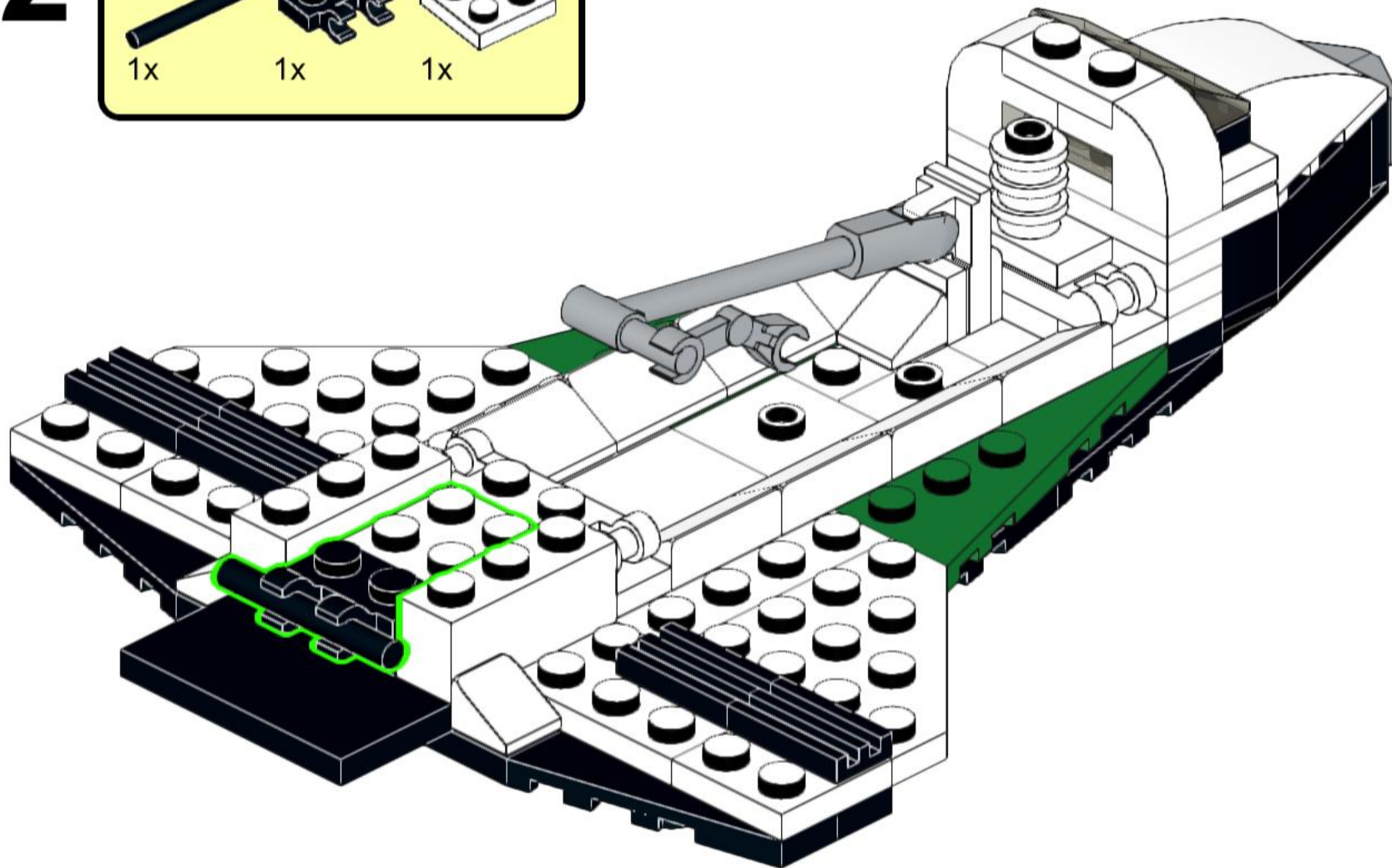
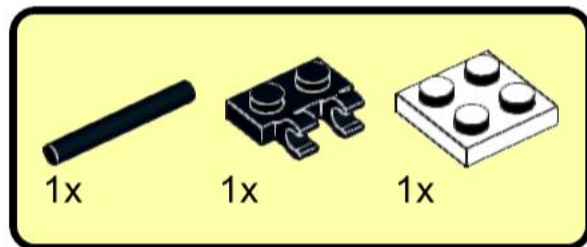

43

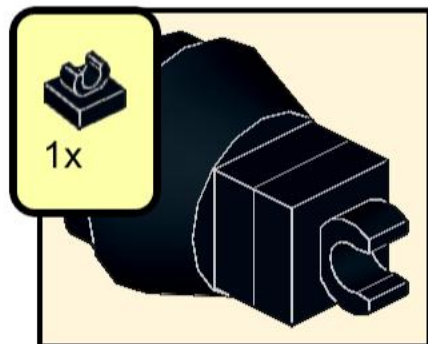

2x

44

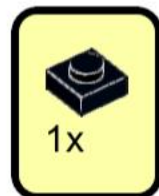

45



46

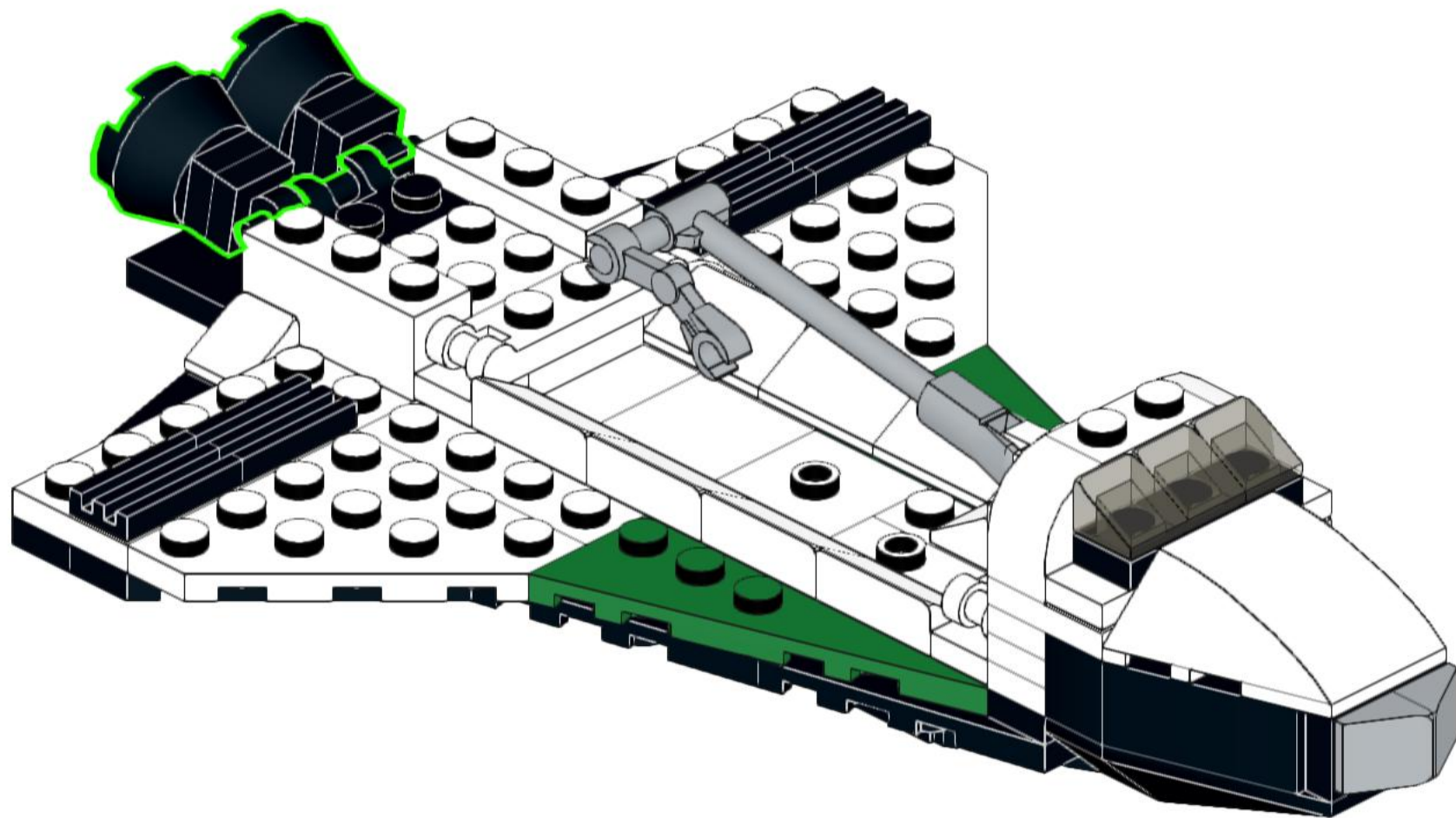



# 47

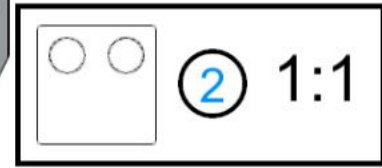
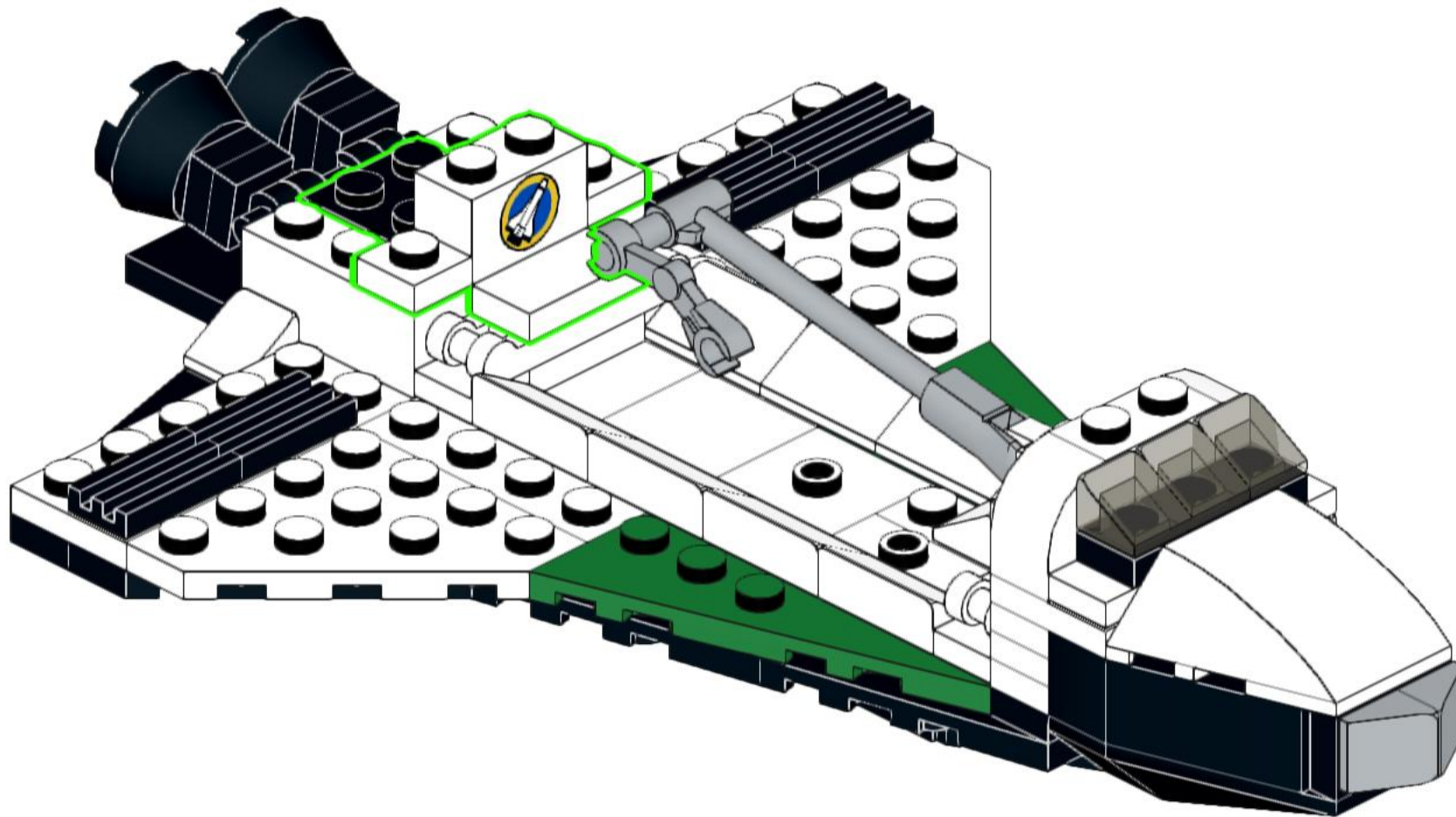
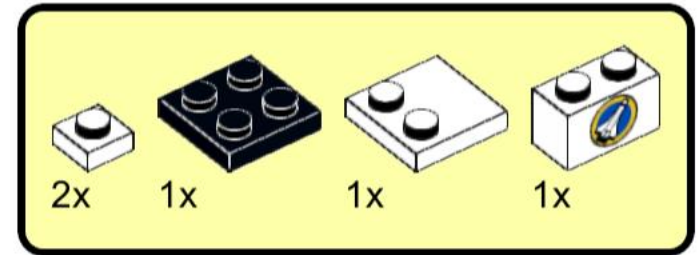

# 48

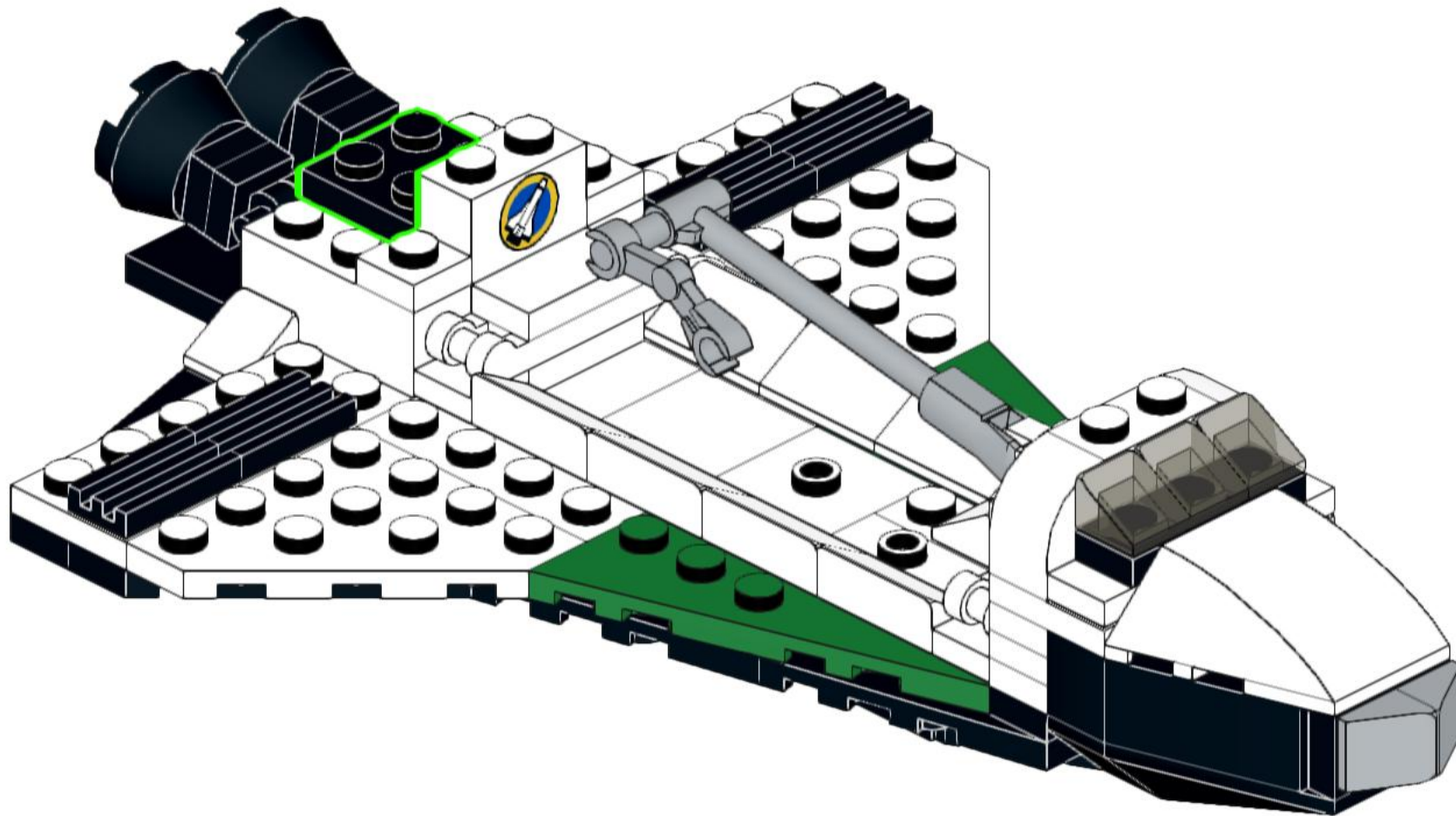
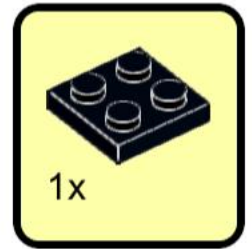

# 49

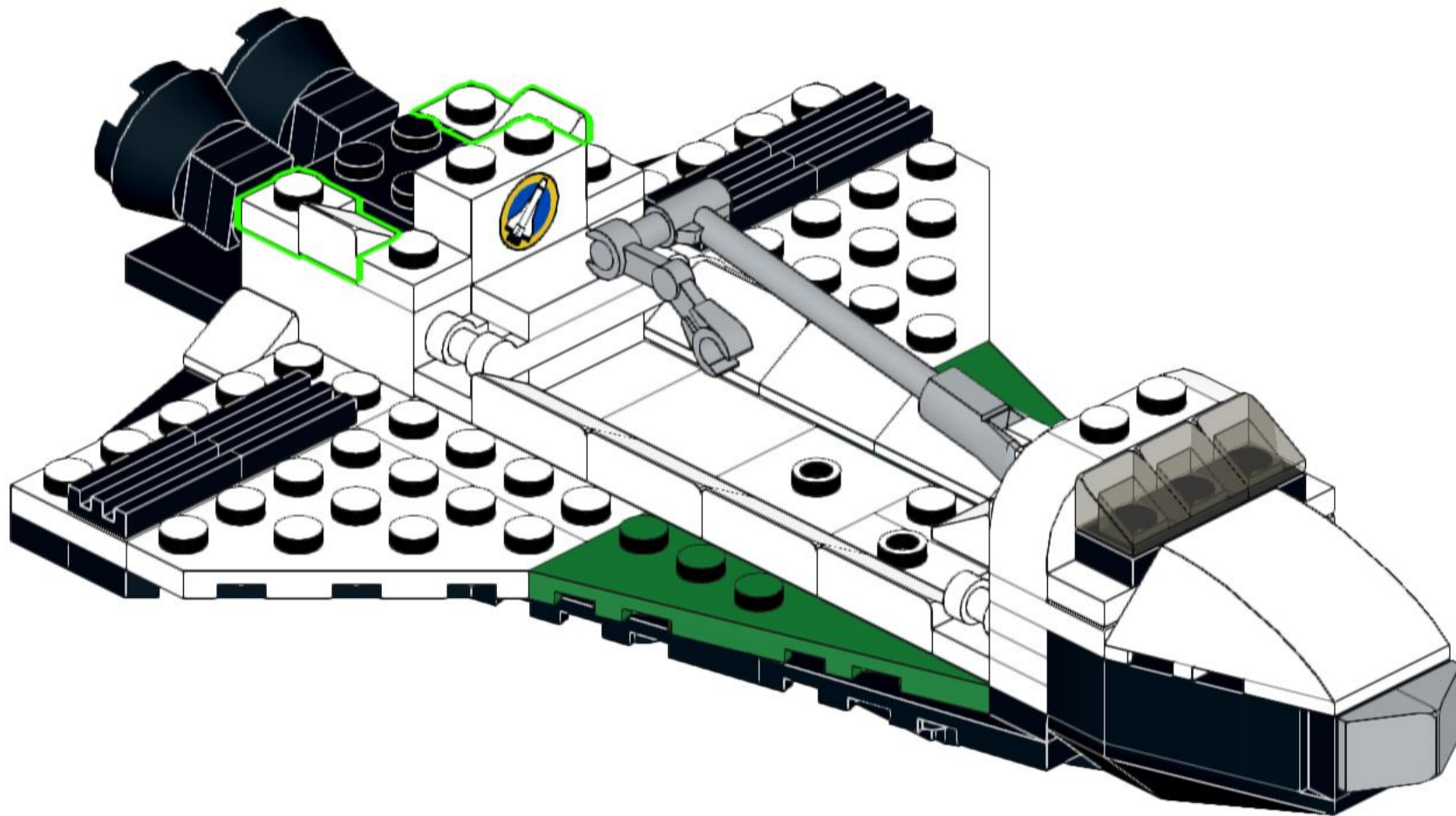
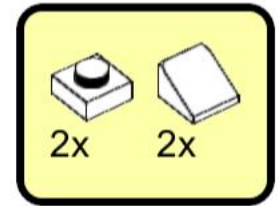



# 50

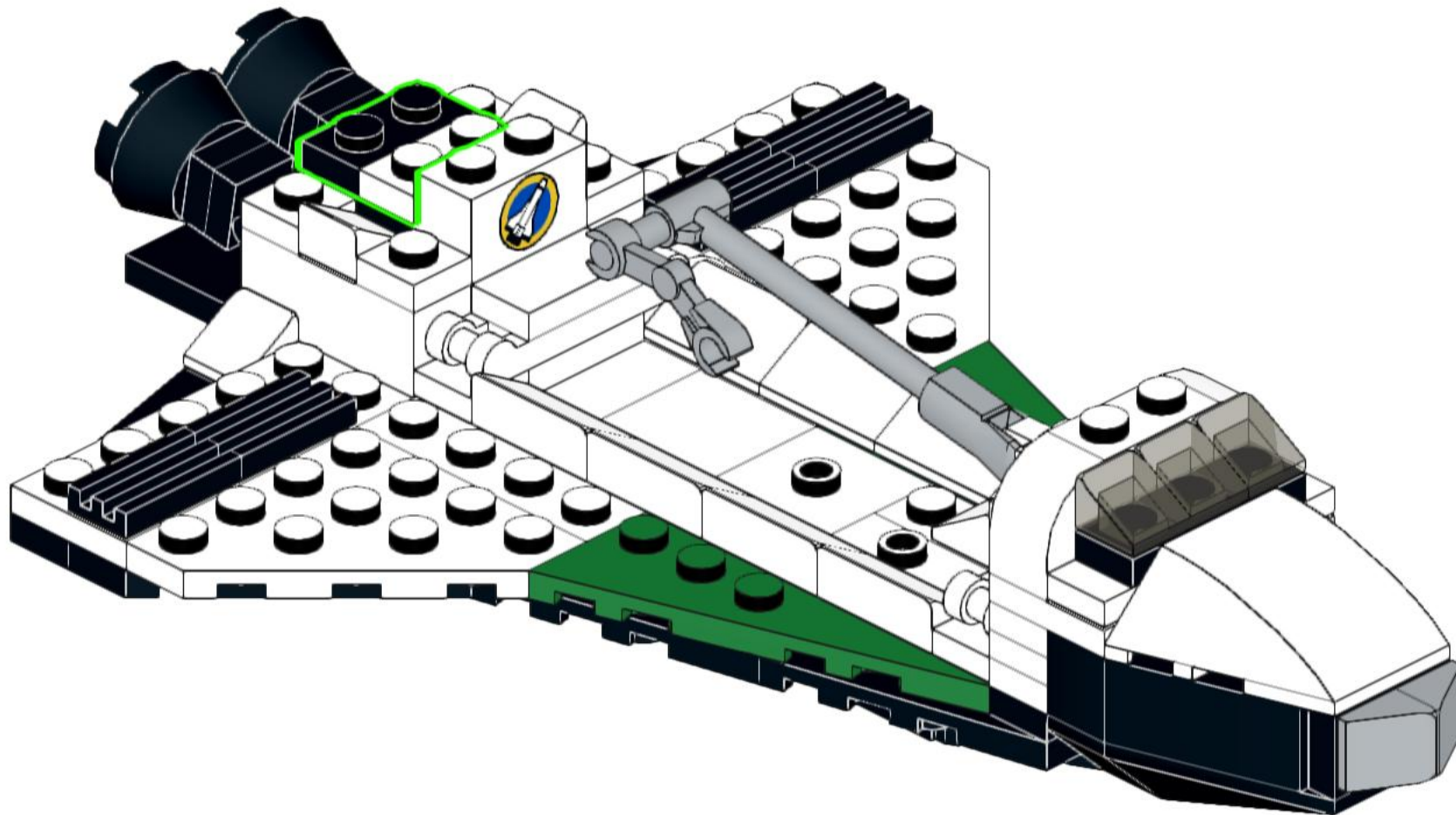
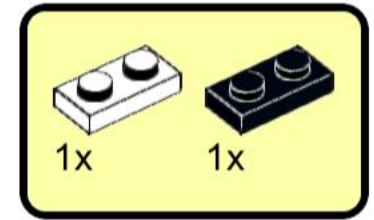



# 51

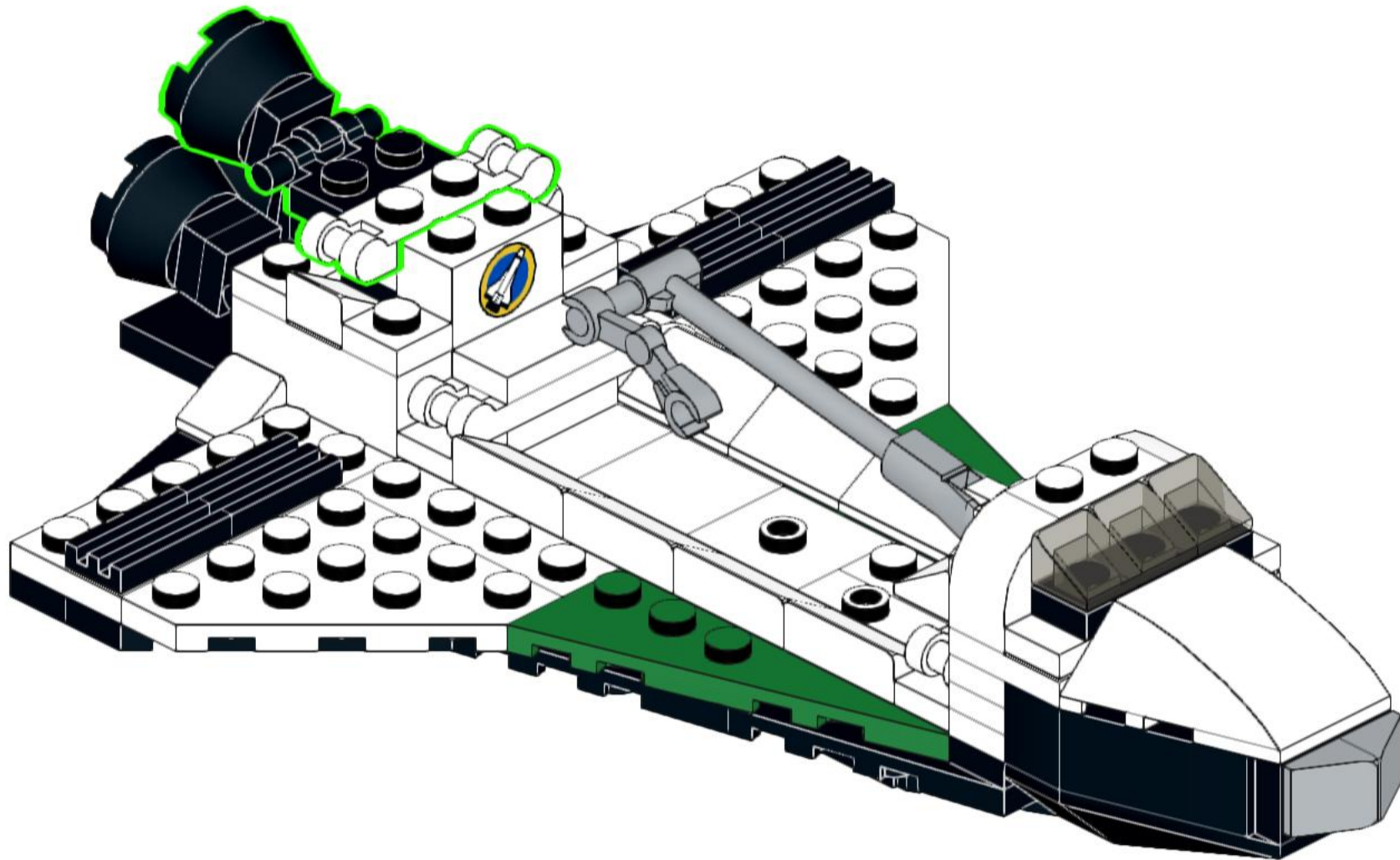
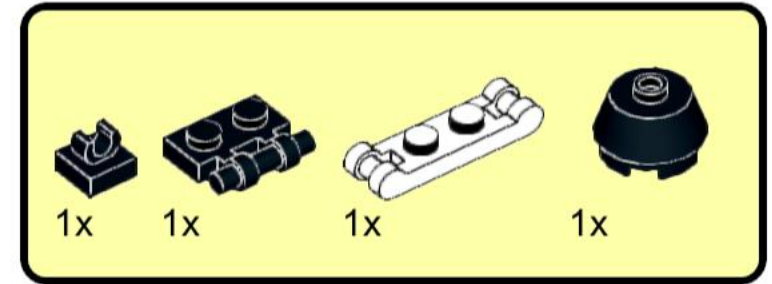

52

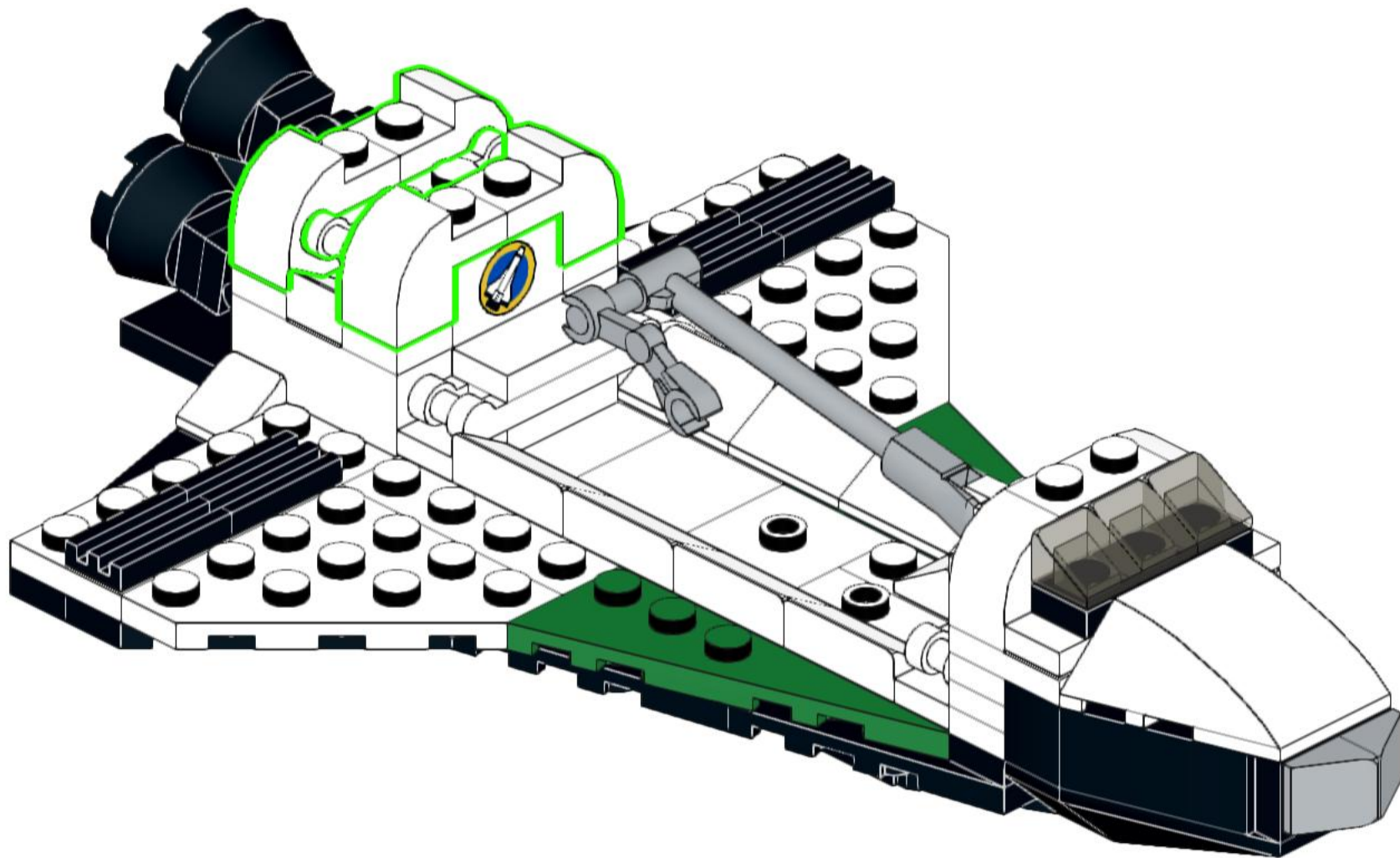
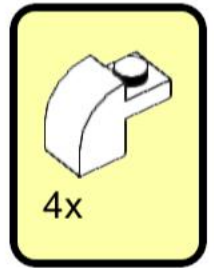

# 53

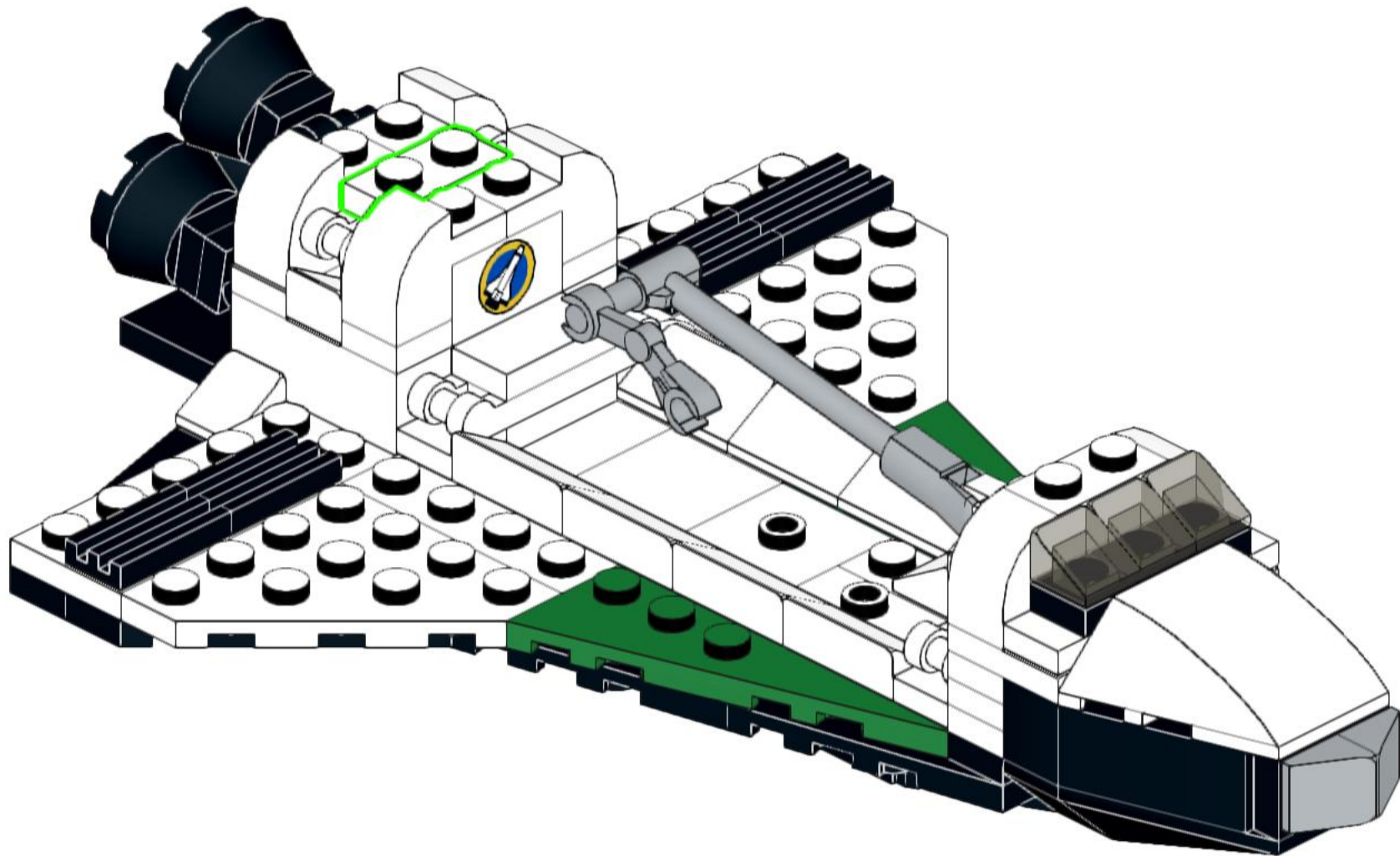
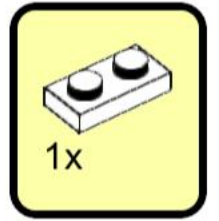



54

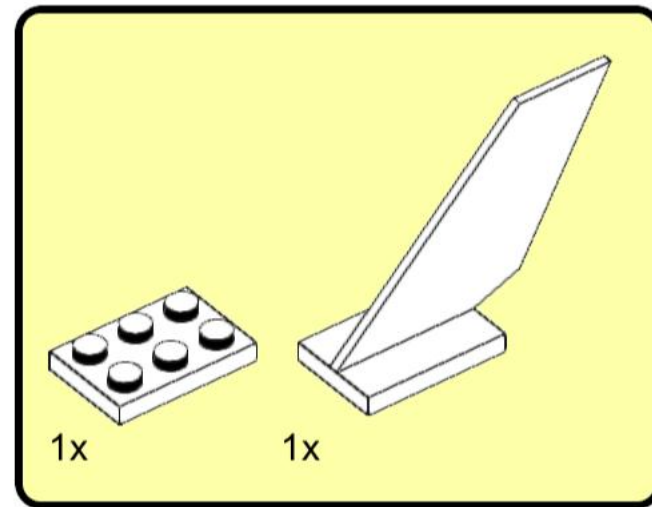
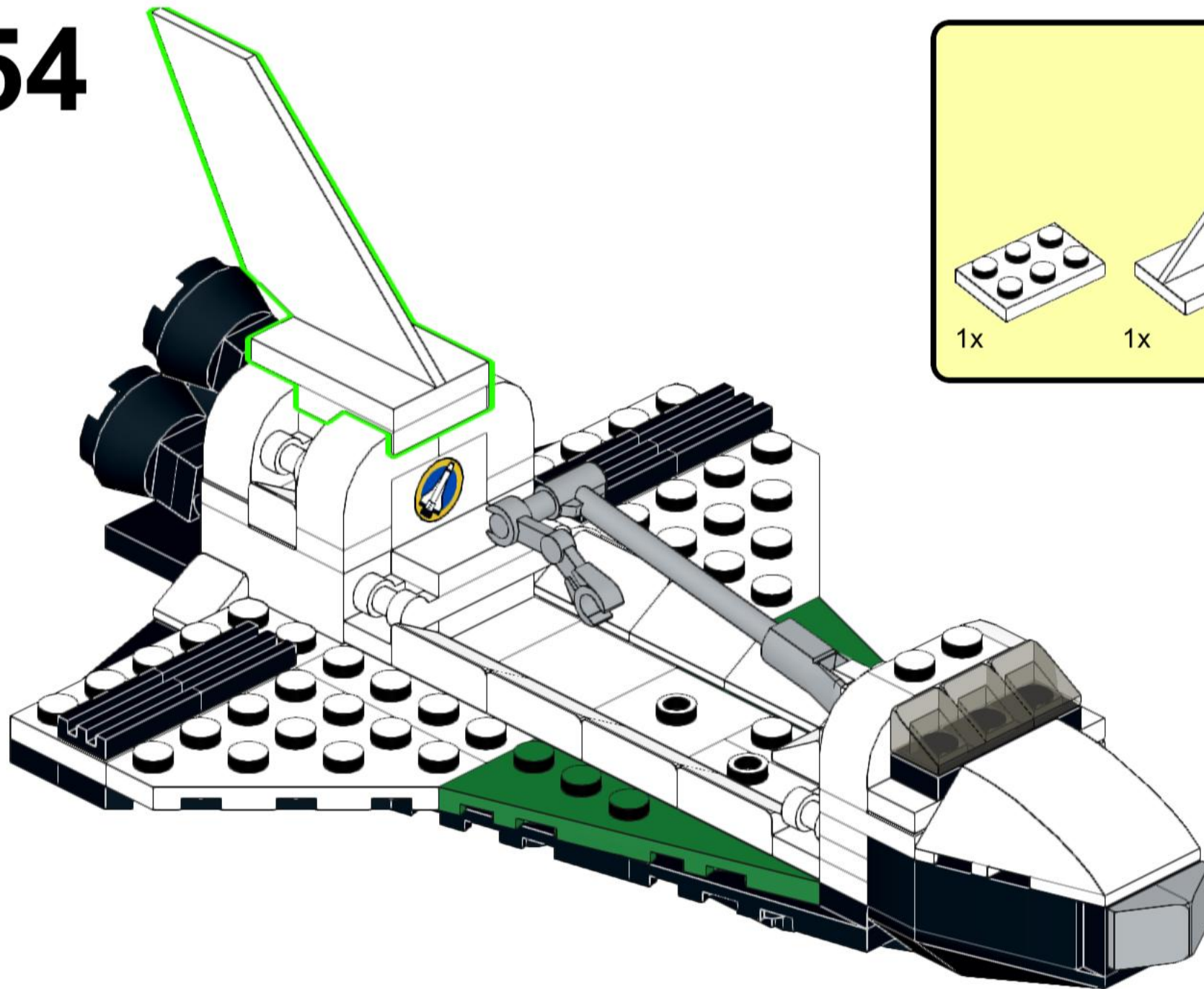

1x

1x



# 55

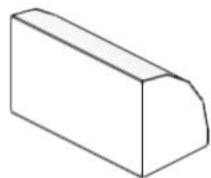
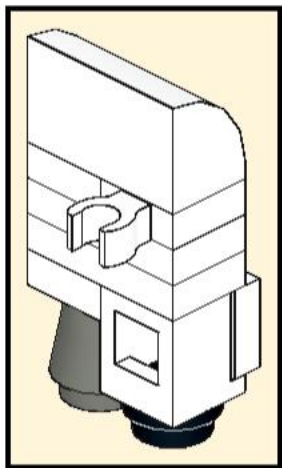
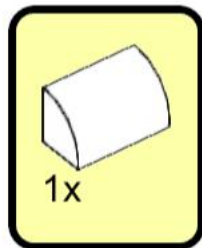

# 56

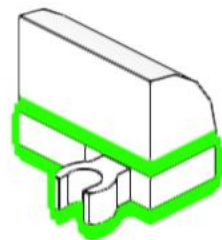
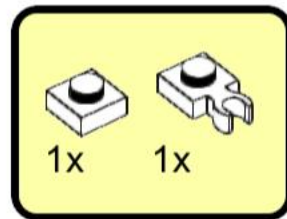

# 57

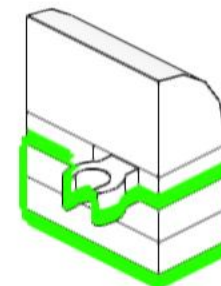
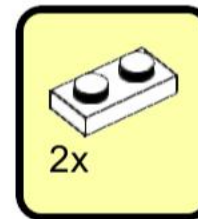

# 58

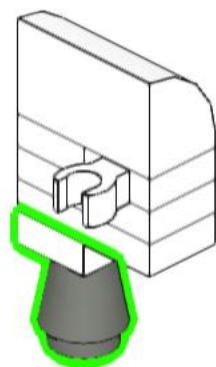
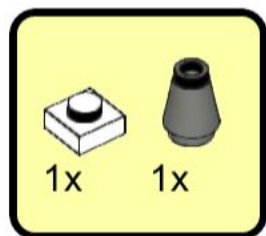

# 59

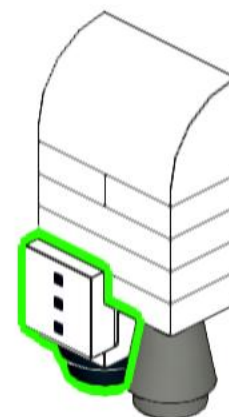
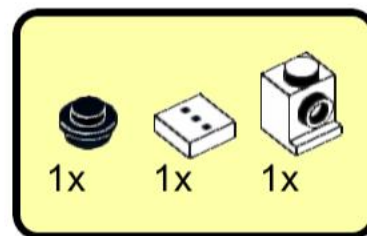

60

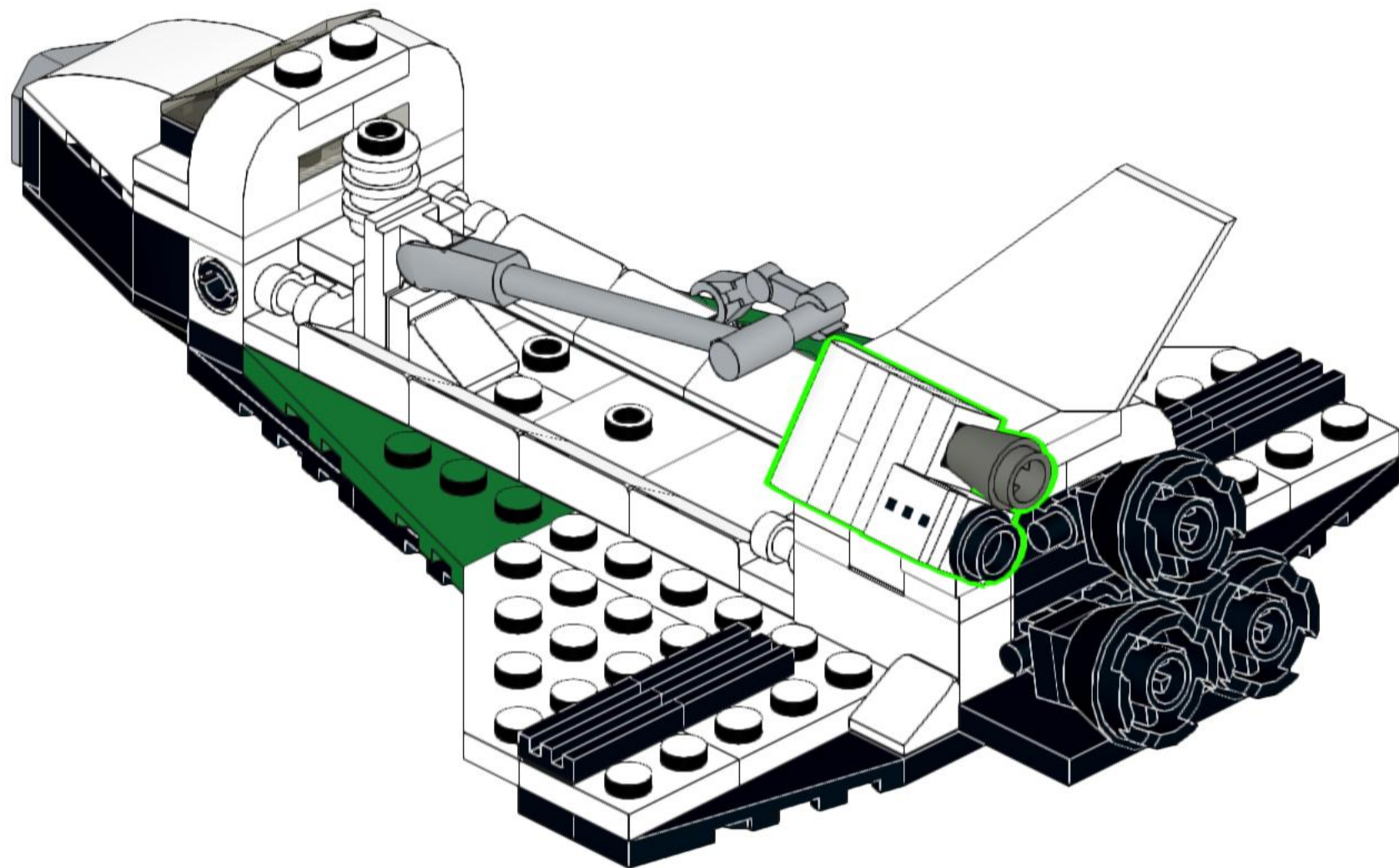

# 61

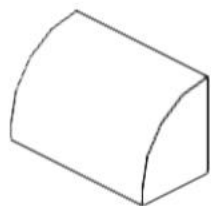
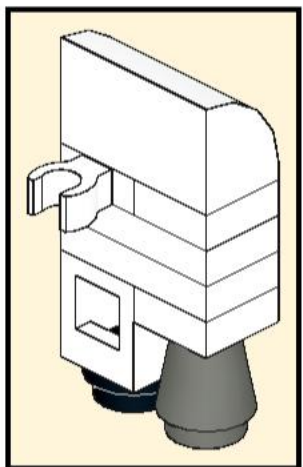
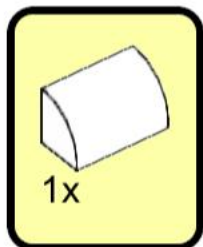

# 62

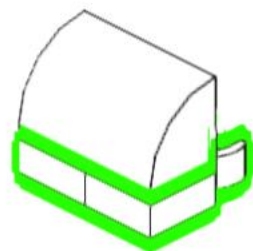
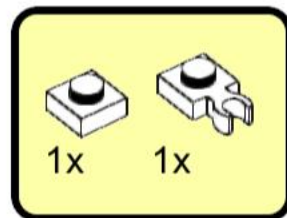

# 63

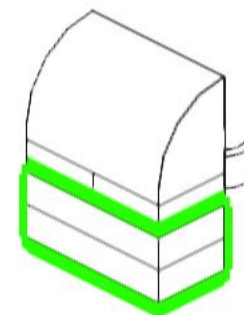
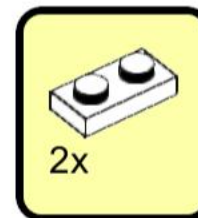



# 64

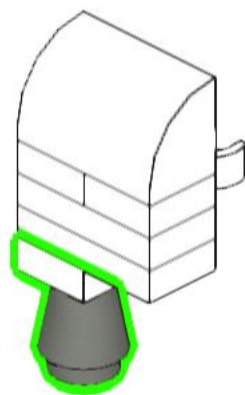
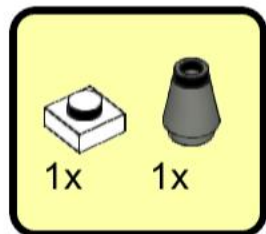

# 65

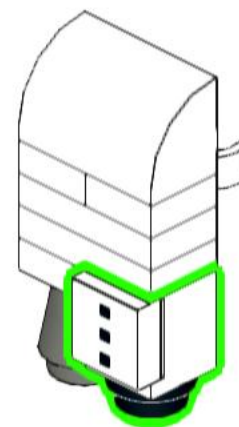
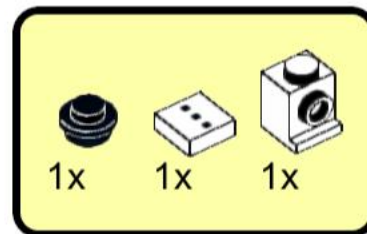

66

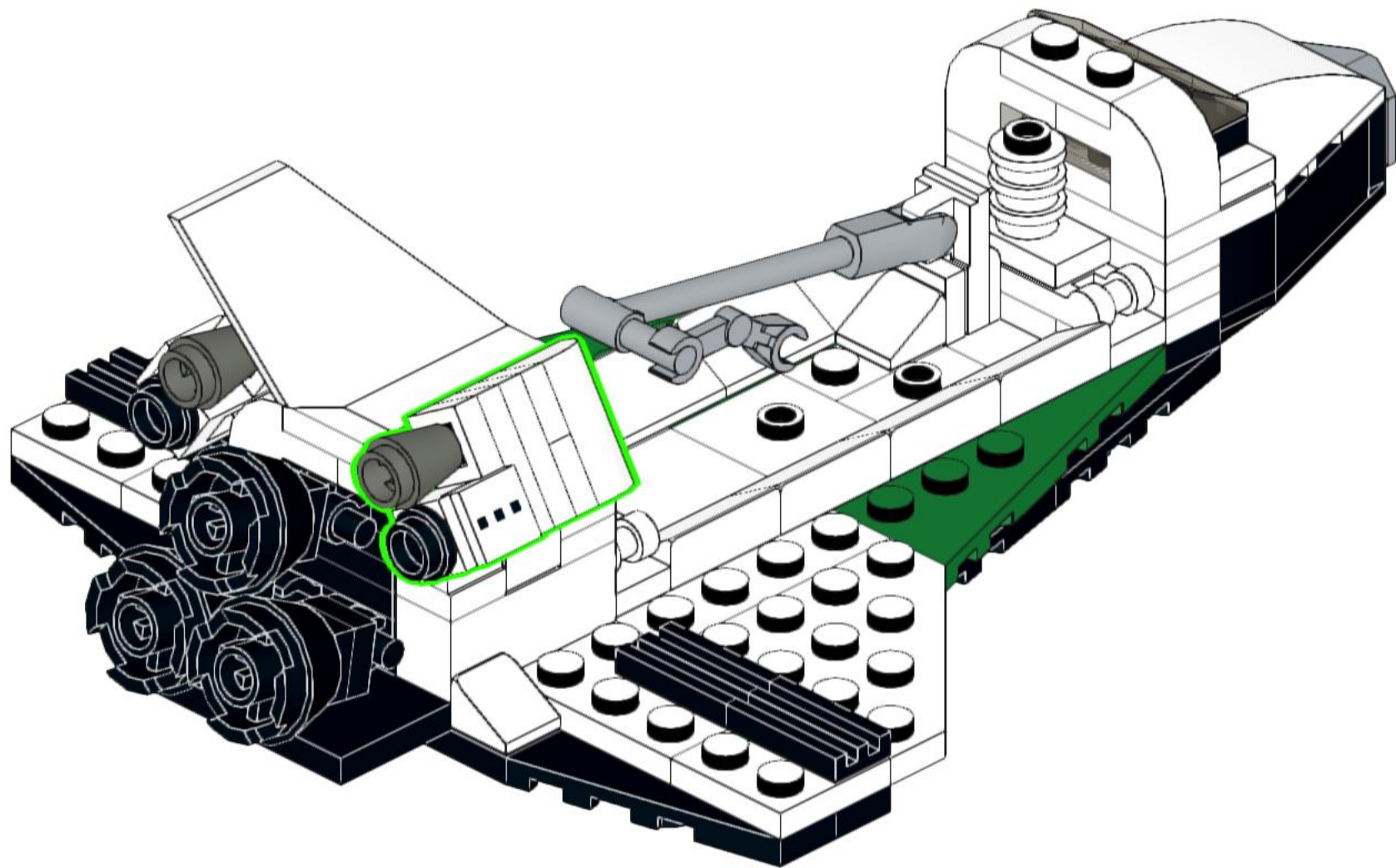

# 67

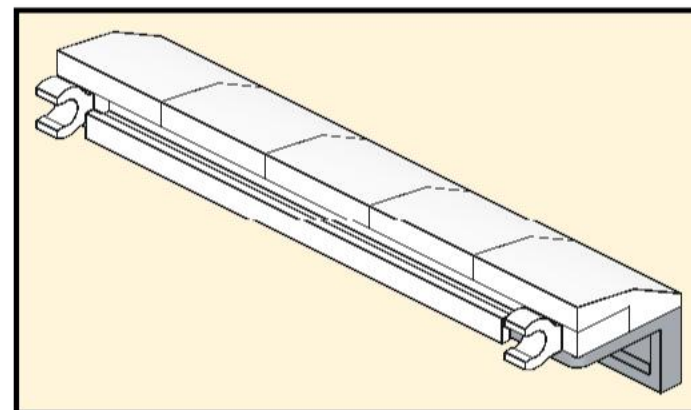
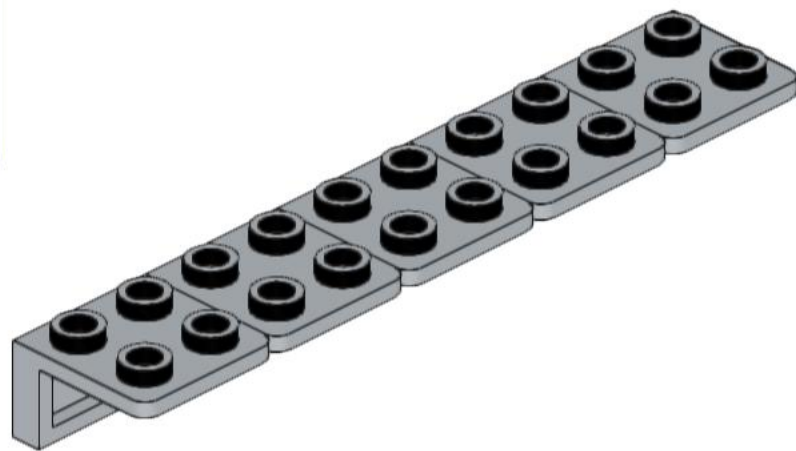
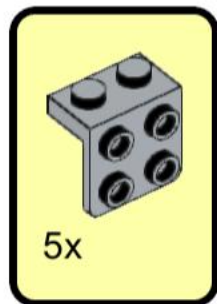

2x

# 68

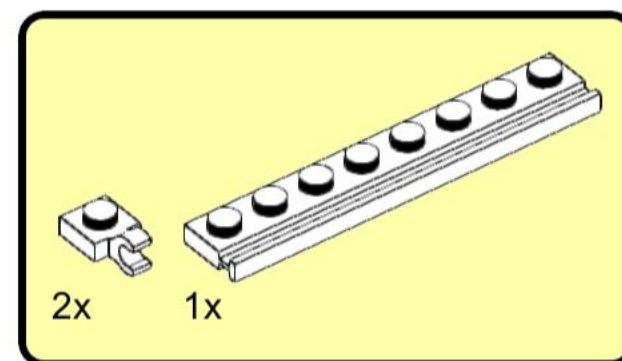
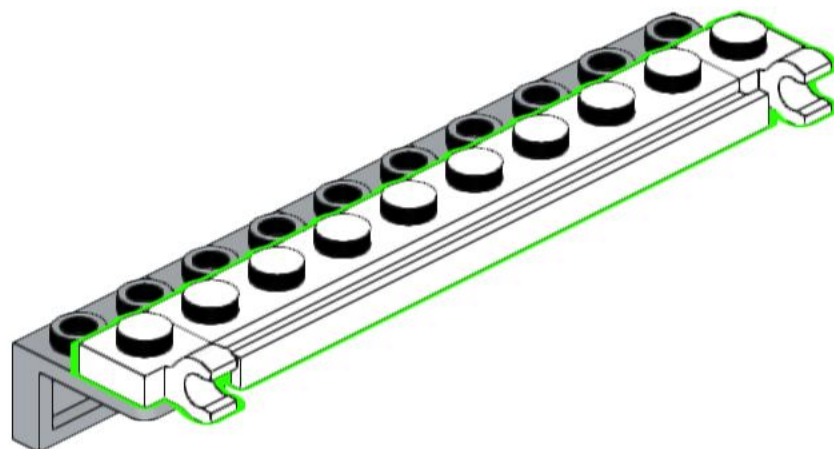

69

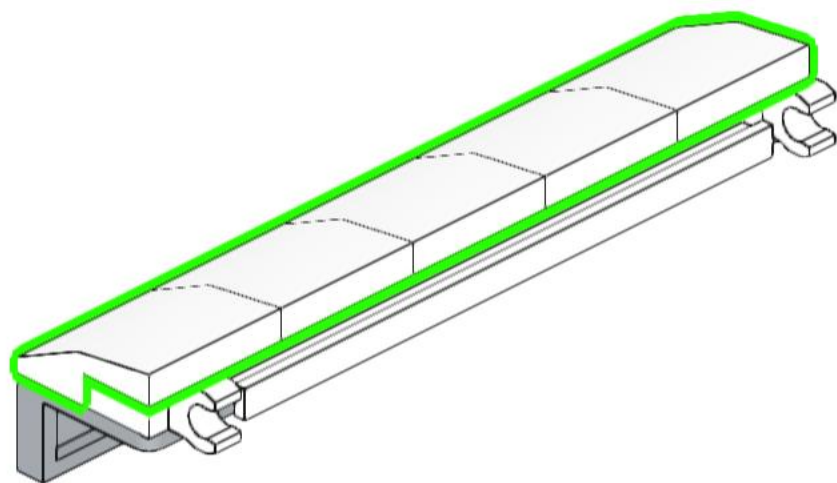
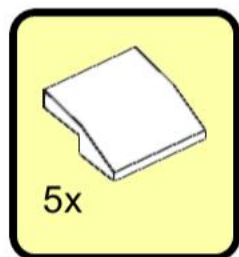

70

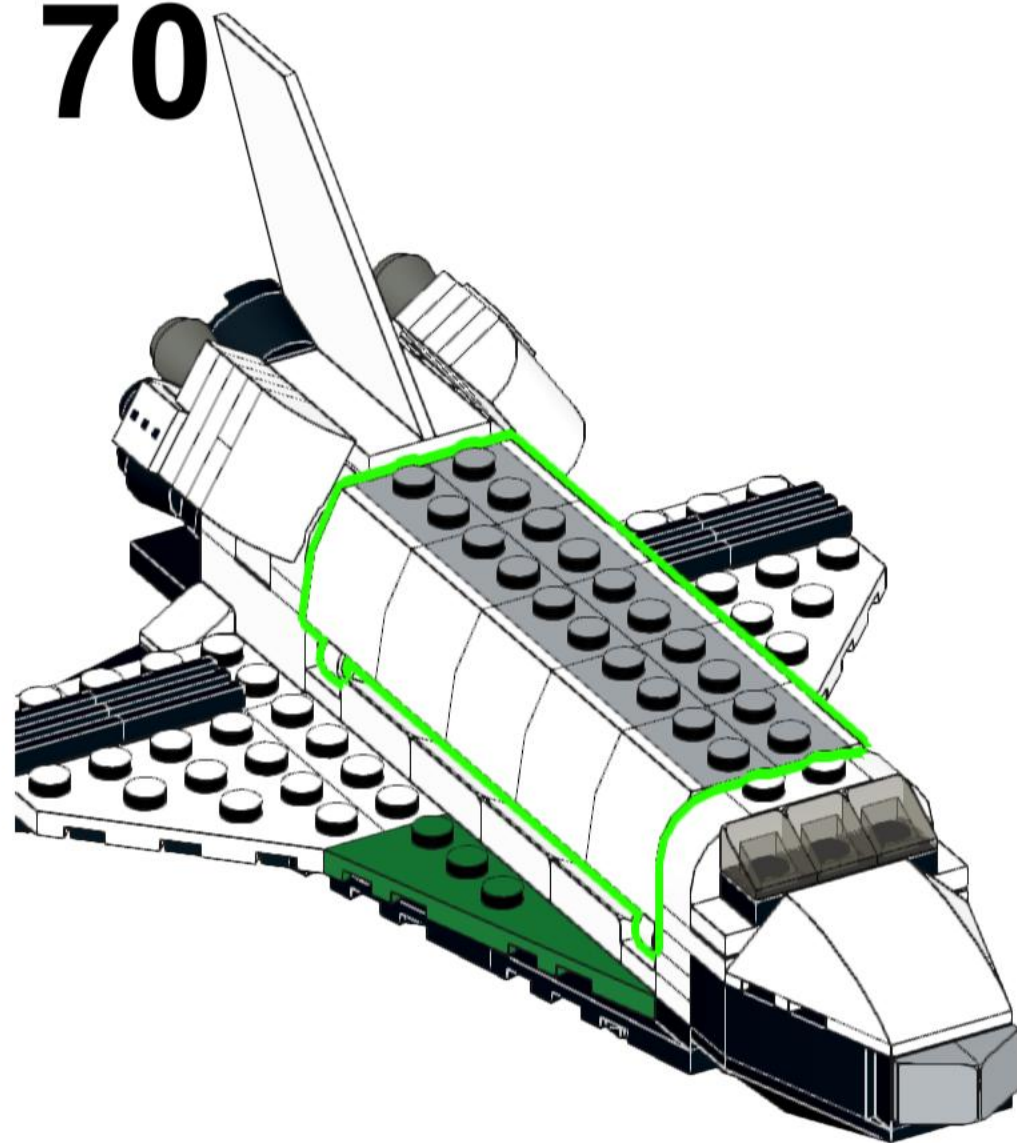



# 71

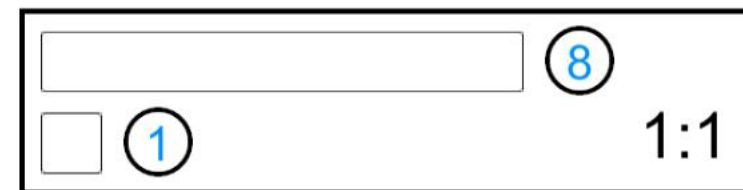
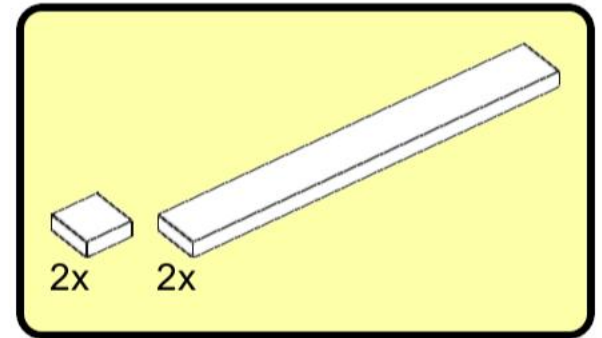
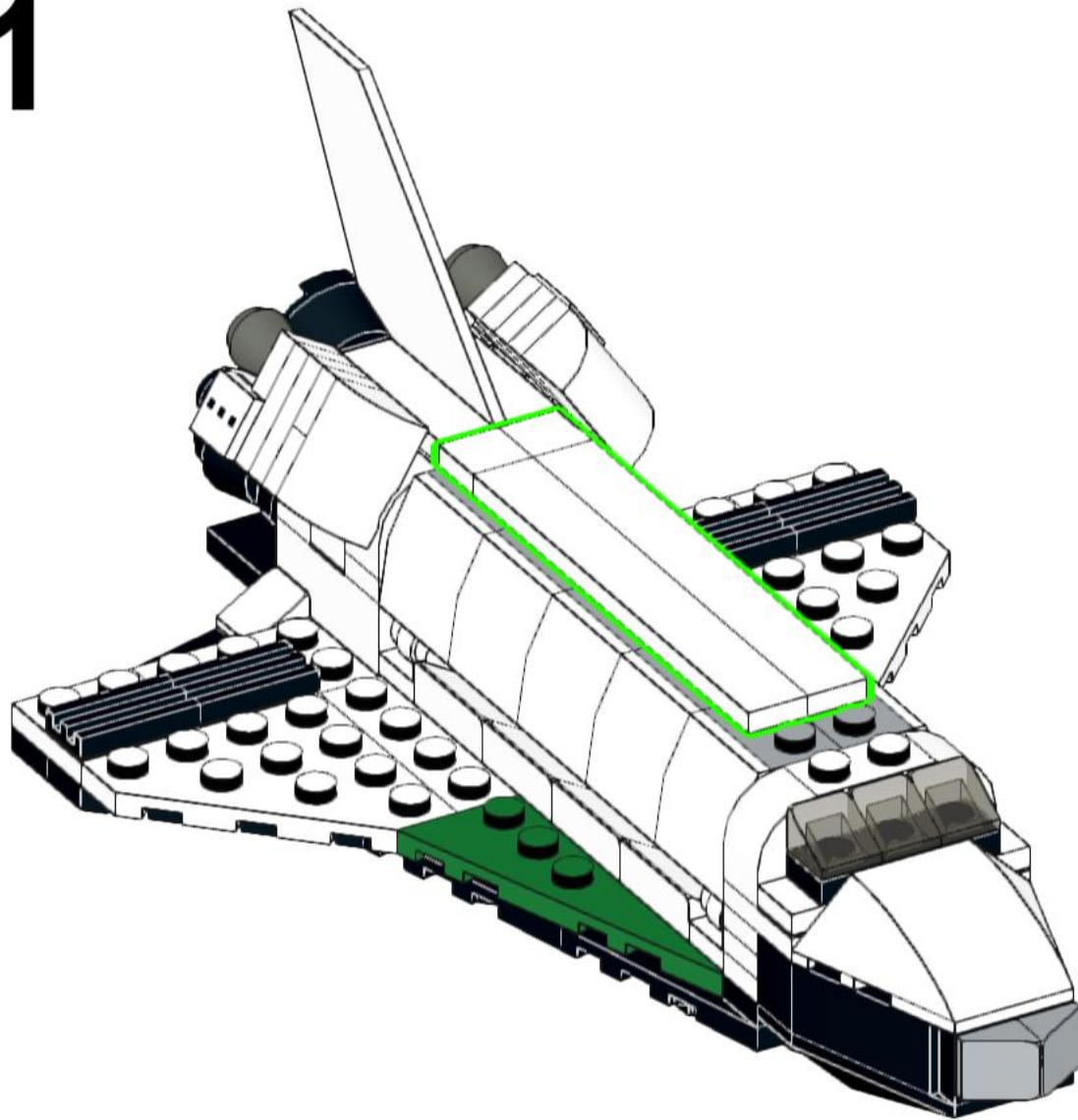

72

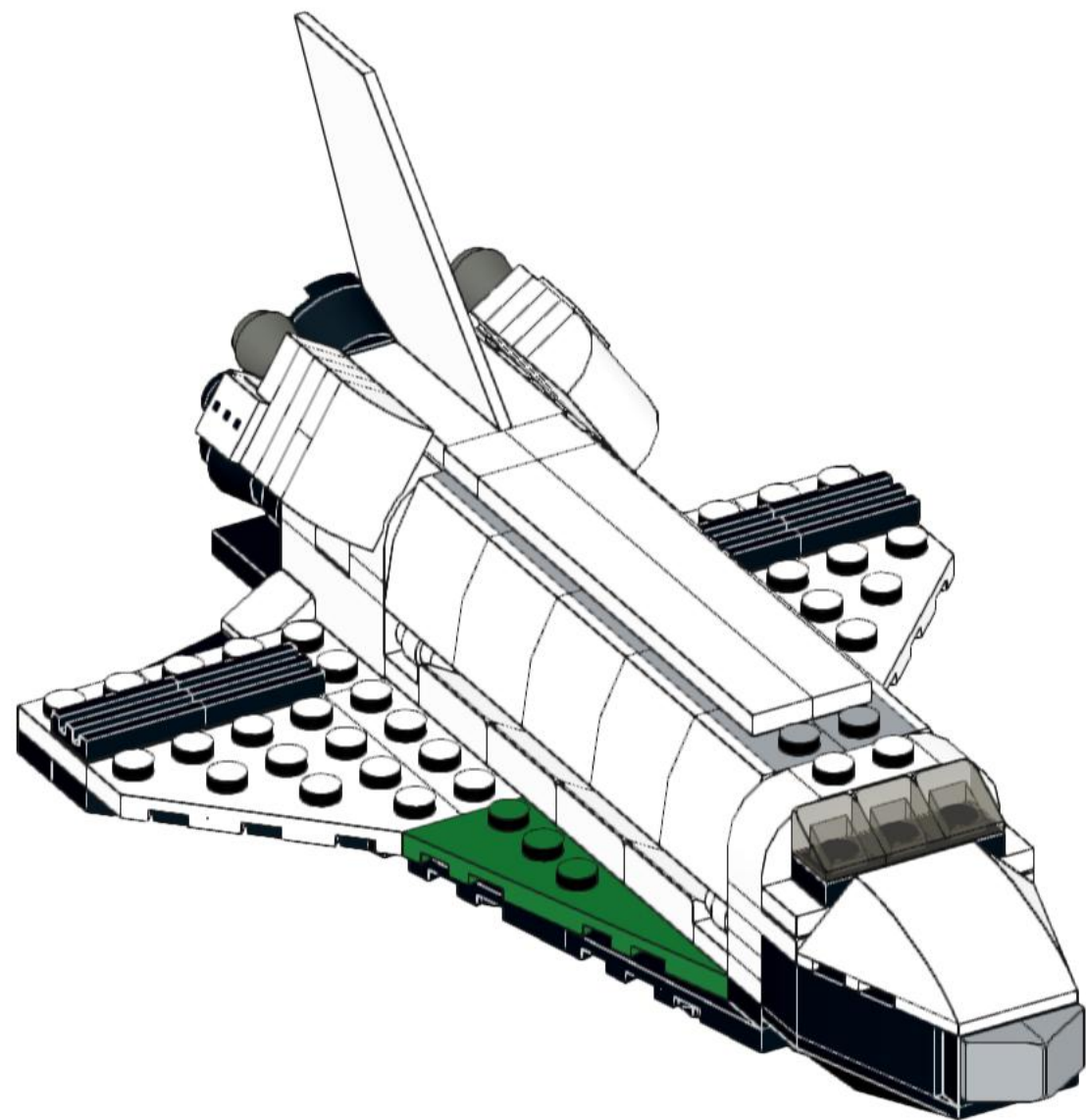

# 73

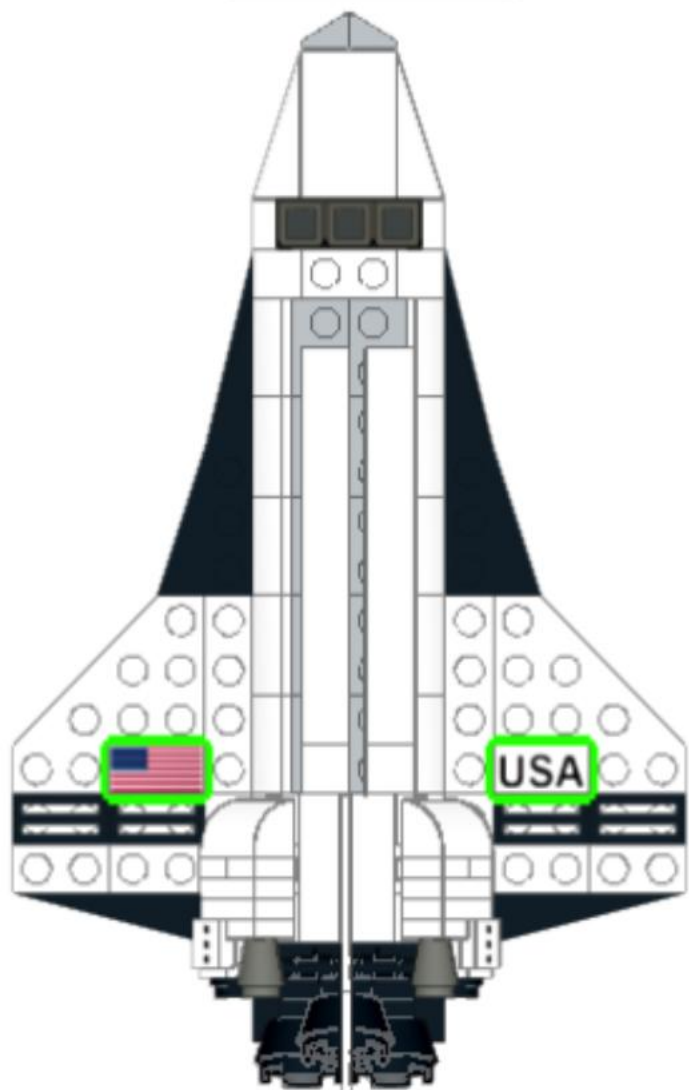
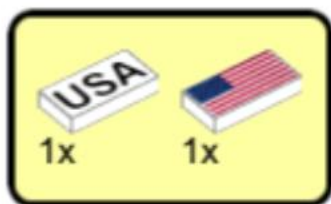

# 74

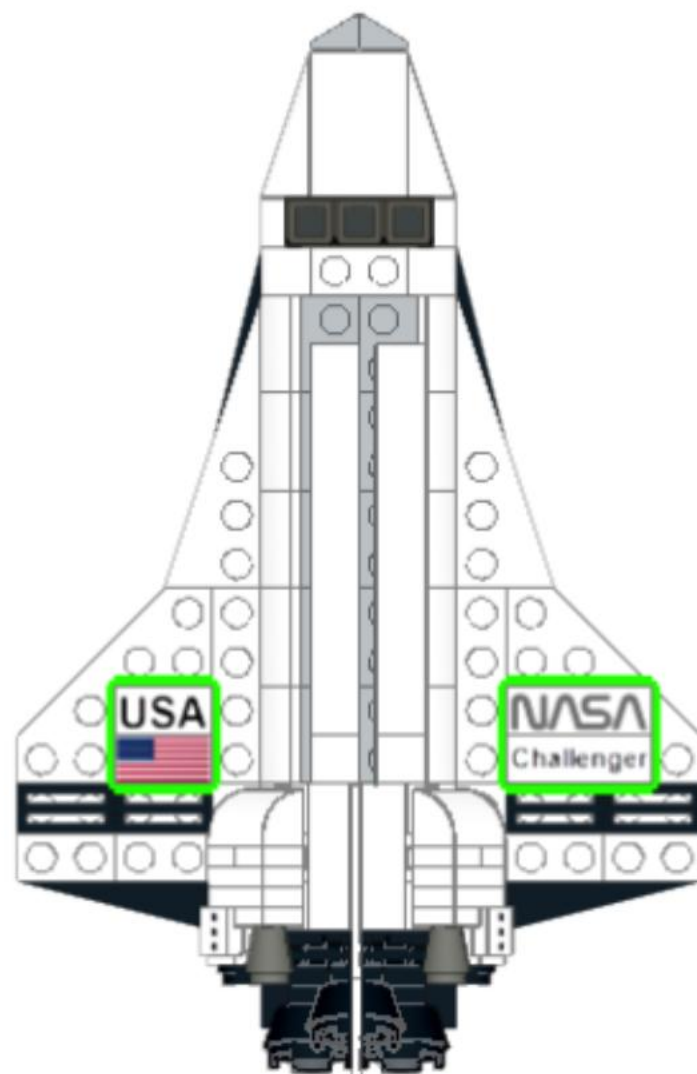
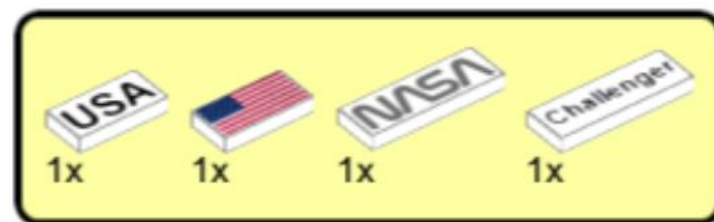

# 75

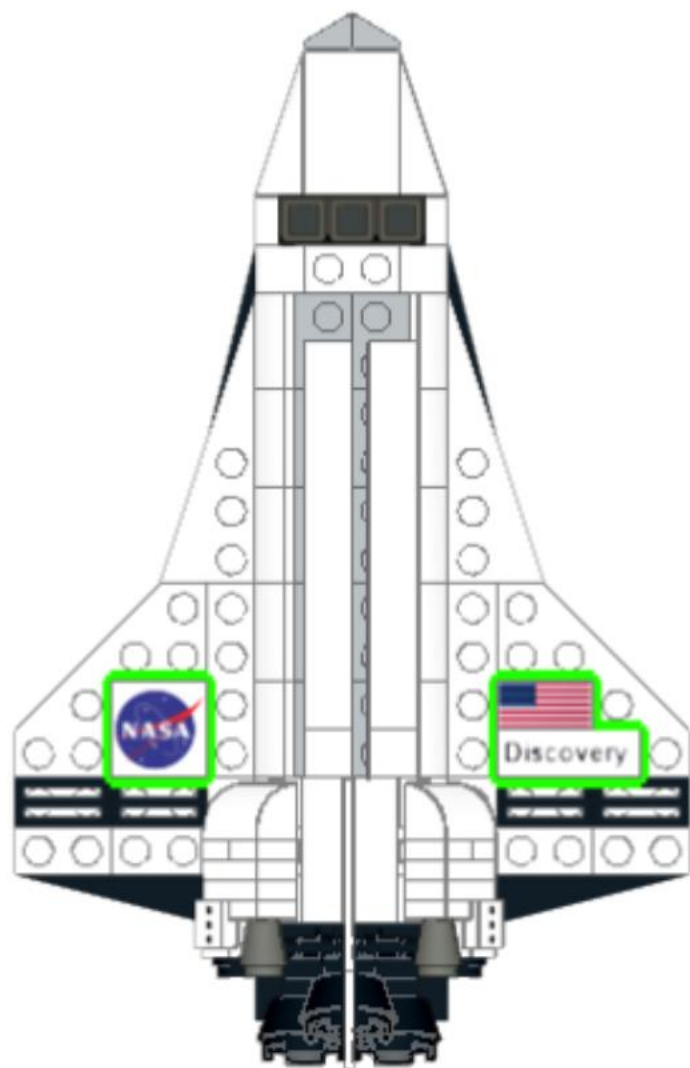
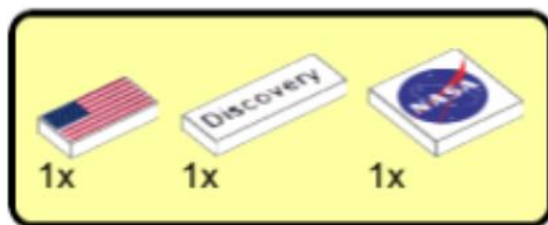

# 76

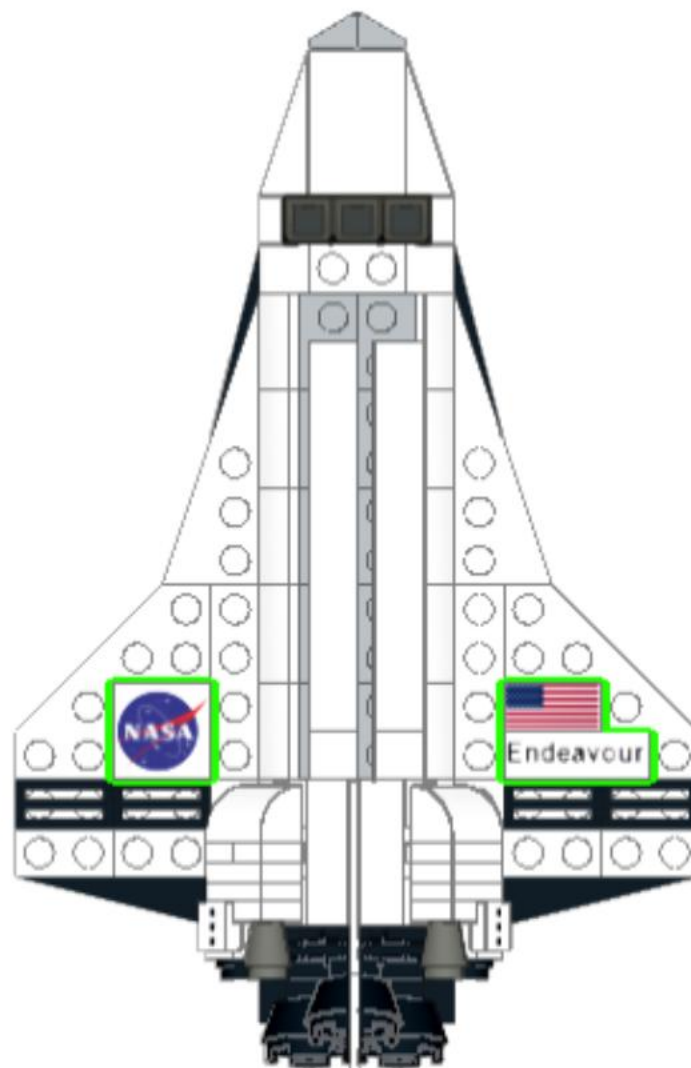
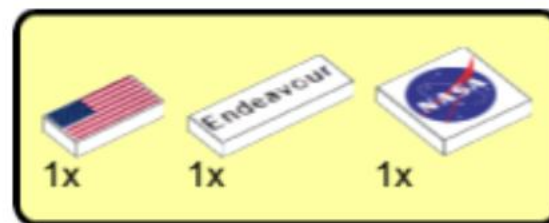



77

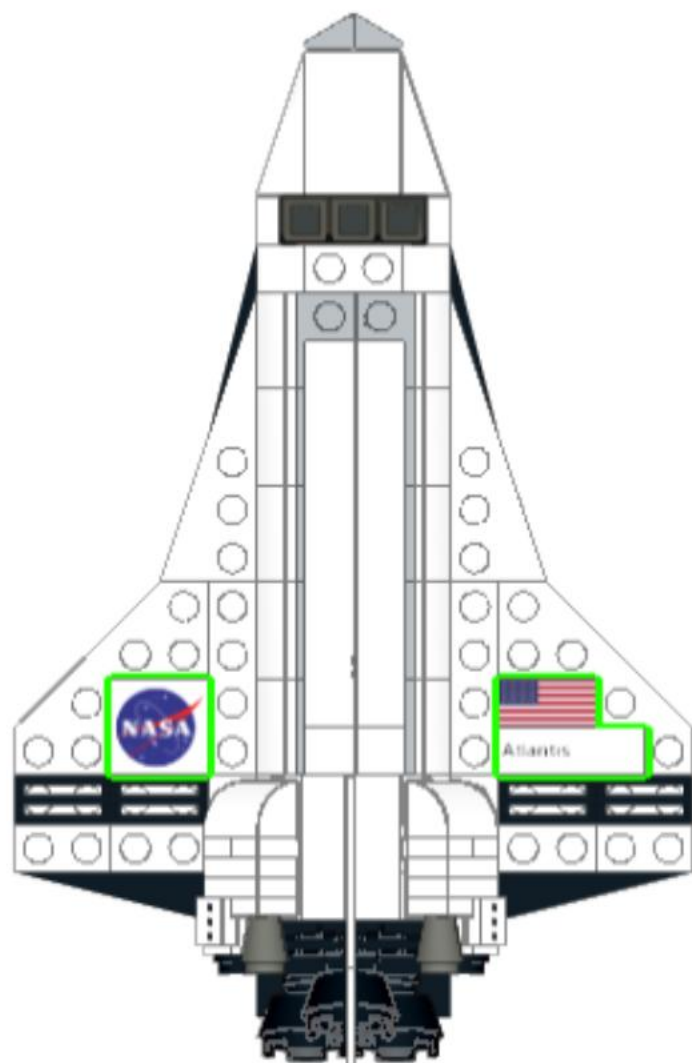
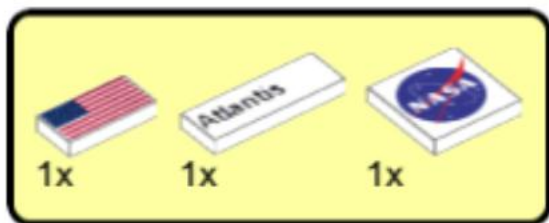



2x  
4073, 11



4x  
2412b, 11



2x  
2654, 11

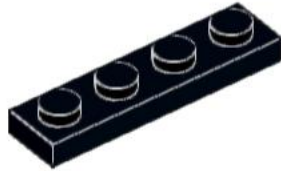

1x  
3710, 11

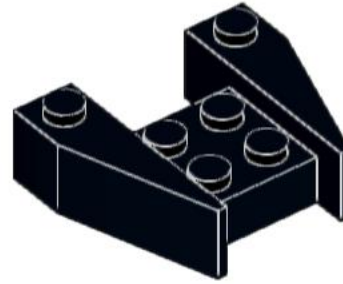

1x  
2399, 11



4x  
3024, 11



1x  
60470b, 11



3x  
3022, 11



3x  
41770, 11

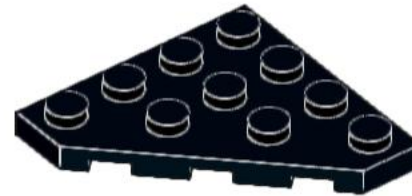

3x  
15712, 11



1x  
2540, 11



1x  
87994, 11



2x  
87087, 11



1x  
24299, 11



3x  
98100, 11



3x  
41769, 11

2x  
30503, 11



1x  
3023, 11



1x  
24307, 11



1x  
3623, 11

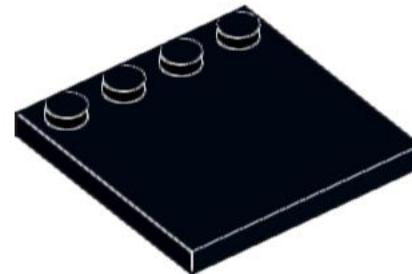

1x  
6179, 11



1x  
2780, 11

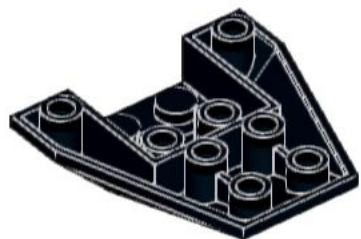

1x  
4855, 11



1x  
3035, 11



1x  
23443, 86



7x  
3070b, 1



1x  
36840, 1



3x  
85861, 1

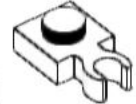

2x  
4085a, 1

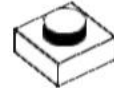

8x  
3024, 1

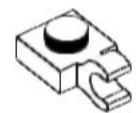

5x  
54200, 1

4x  
61252, 1



1x  
30377, 86

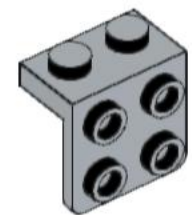

10x  
44728, 86

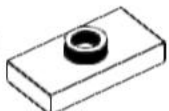

4x  
3794b, 1

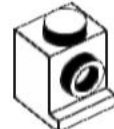

2x  
4070, 1

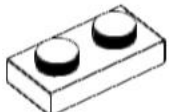

12x  
3023, 1

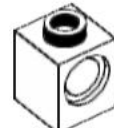

2x  
6541, 1

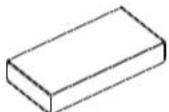

2x  
3069b, 1



1x  
3958, 11



2x  
4589b, 85



2x  
3022, 85

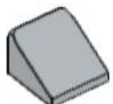

2x  
54200, 86

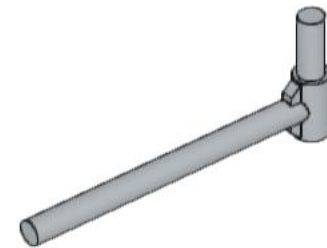

1x  
87618, 86



2x  
3070bpb085, 1

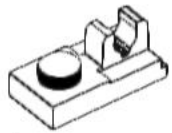

1x  
92280, 1

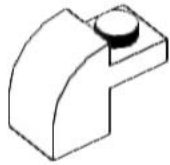

6x  
6091, 1

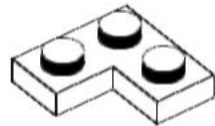

1x  
2420, 1

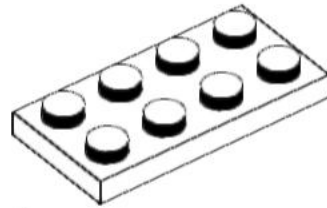

4x  
3020, 1

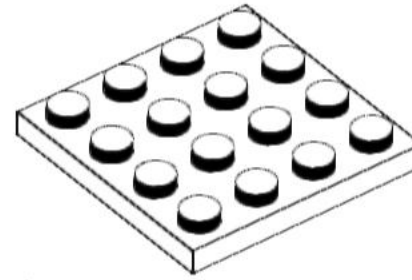

1x  
3031, 1

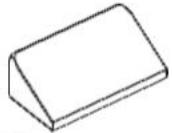

8x  
85984, 1

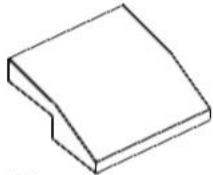

10x  
15068, 1

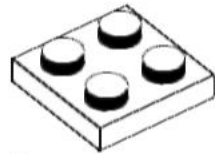

5x  
3022, 1

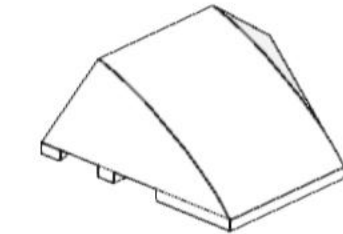

1x  
64225, 1



2x  
37352, 1

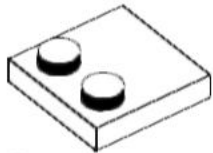

1x  
33909, 1

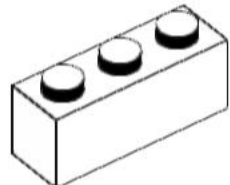

2x  
3622, 1



1x  
3004pb010, 1

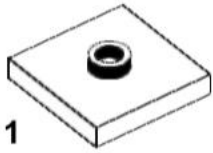

1x  
87580, 1

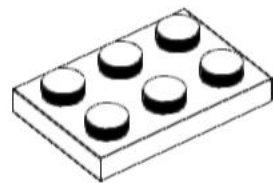

4x  
3021, 1

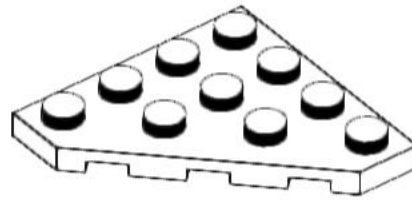

2x  
30503, 1

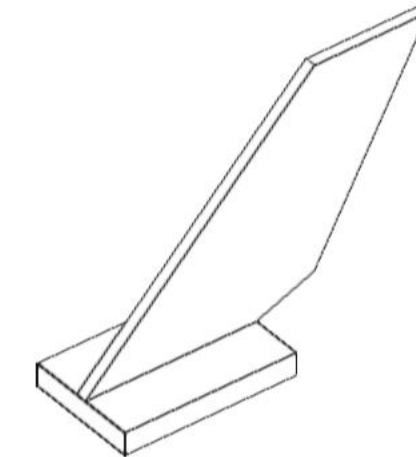

1x  
6239, 1

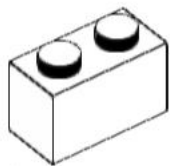

1x  
3004, 1

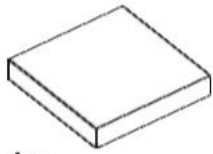

1x  
3068b, 1

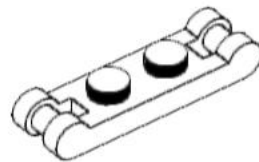

3x  
18649, 1

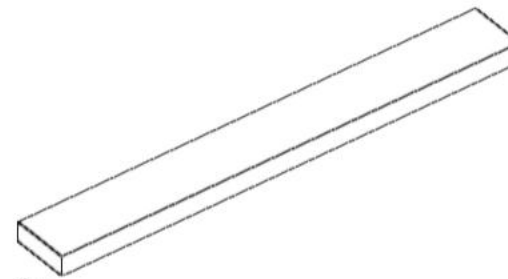

2x  
4162, 1



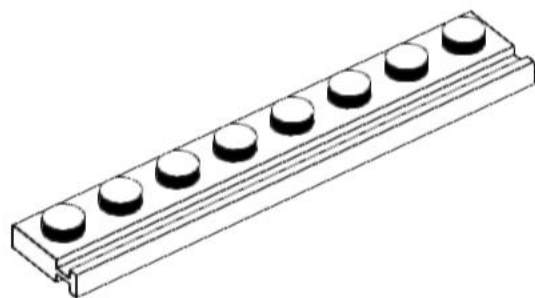

2x  
4510, 1

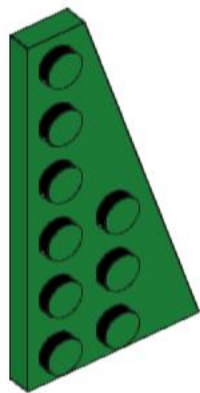

1x  
54383, 6

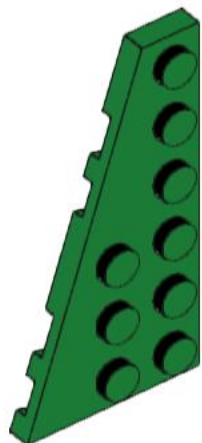

1x  
54384, 6

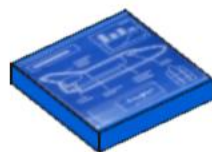

1x



3x  
54200, 13

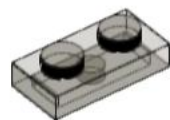

1x  
3023, 13

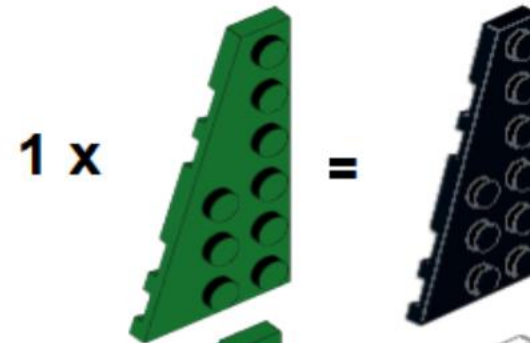

=

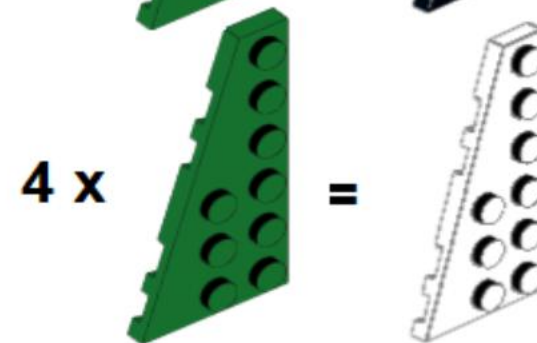

=

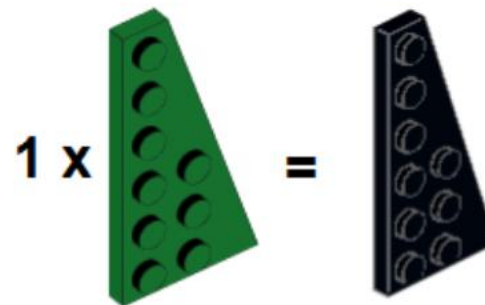

=

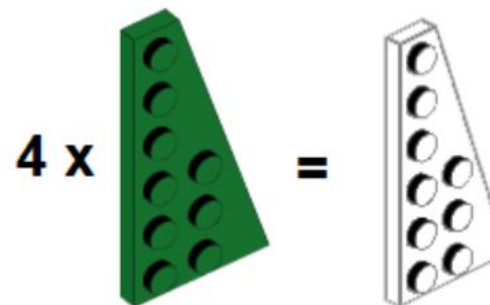

=

